



# Series 998

## User's Manual



### Dual Channel, 1/8 DIN, Microprocessor-Based Temperature/Process Controller

**User Levels:**

- New User..... go to Introduction
- Experienced User..... go to page 4.1
- Expert User..... go to page 4.1

**Installers:**

- Set-up..... go to page 1.1
- Installation & Wiring .....go to page 2.1



**TOTAL  
CUSTOMER  
SATISFACTION**

3 Year Warranty

**ISO 9001**



Registered Company  
Winona, Minnesota USA



**Watlow Controls**

1241 Bundy Boulevard, P.O. Box 5580, Winona, Minnesota USA 55987-5580  
Phone: (507) 454-5300, Fax: (507) 452-4507 <http://www.watlow.com>

**0600-0010-000 Rev G**

February 2000

Supersedes: W998-XUMN Rev F

**\$10.00**

**Made in the U.S.A.**



Printed on Recycled Paper 10% Postconsumer Waste

**NOTE:**

Details of a “Note” appear here in the narrow box on the outside of each page.

**CAUTION:**

Details of a “Caution” appear here in the narrow box on the outside of each page.

**WARNING:**

Details of a “Warning” appear here in the narrow box on the outside of each page.

## Safety Information

We use note, caution and warning symbols throughout this book to draw your attention to important operational and safety information. A bold text “NOTE” marks a short message in the margin to alert you to an important detail.

A bold text “CAUTION” safety alert appears with information that is important for protecting your equipment and performance. Be especially careful to read and follow all cautions that apply to your application.

A bold text “WARNING” safety alert appears with information that is important for protecting you, others and equipment from damage. Pay very close attention to all warnings that apply to your application.

The safety alert symbol, , (an exclamation point in a triangle) precedes a general CAUTION or WARNING statement.

## Technical Assistance

If you encounter a problem with your Watlow controller, review all of your configuration information for each step of the setup to verify that your selections are consistent with your applications.

If the problem persists, an Application Engineer can discuss your application with you.

Before calling, please have the complete model number and user’s manual available. You can get technical support by dialing 507/494-5656, 7 a.m. to 7 p.m. Central Standard Time.

## Your Feedback

Your comments or suggestions on this manual are welcome, please send them to: Technical Writer, Watlow Controls, P.O. Box 5580, Winona, MN 55987-5580, Phone: (507) 454-5300, Fax: (507) 452-4507. The *Series 998 User’s Manual* is copyrighted by Watlow Winona, Inc., © February 2000, with all rights reserved. (1832)

# Table of Contents

## Introduction

### Starting Out with the Watlow Series 998

- i The Series 998
- ii Display Loop
- ii Operation Menus
- iii Setup Menus
- iii Factory Menus

## Chapter 1

### Hardware Setup

- 1.1 DIP Switch Locations and Functions
- 1.2 Input Type DIP Switches
- 1.3 External Power Supply DIP Switches
- 1.4 Setting the Lockout DIP Switch

## Chapter 2

### Installation and Wiring

- 2.1 Panel Cutout and Dimensions
- 2.2 Installing the Series 998
- 2.4 Wiring the Series 998
- 2.4 Power Wiring
- 2.4 Sensor Installation Guidelines
- 2.5 Event Input 1 Wiring
- 2.5 Wiring 0-20mA and 4-20mA Process Inputs
- 2.6 Wiring Example
- 2.7 Wiring Notes
- 2.8 Channel A Input Wiring
- 2.9 Channel B Input Wiring
- 2.10 Channel A Output Wiring
- 2.11 Channel B Output Wiring
- 2.12 Output 3 Wiring
- 2.13 Output 4 Wiring

## Chapter 3

### Keys and Displays

- 3.1 Keys and Displays
- 3.2 Display Key and Loop

## Chapter 4

### The Setup Menus

- 4.1 Navigating the Setup Menus
- 4.2 Input Menu
- 4.16 Output Menu
- 4.32 Global Menu

## Chapter 5

### The Operation Menus

- 5.1 Navigating the Operation Menus
- 5.2 The System Menu
- 5.3 The Set Point Menu
- 5.3 System Prompts
- 5.8 PID A Menu
- 5.13 PID B Menu

## Chapter 6

### The Factory Menus

- 6.1 Navigating the Factory Menus
- 6.2 Panel Lockout Menu
- 6.8 Diagnostics Menu
- 6.14 Calibration Menu

## Chapter 7

### Tuning, Manual Operation, Alarms and Error Codes

- 7.1 Auto-tuning (Heat and/or Cool)
- 7.2 Manual Tuning
- 7.3 Manual and Automatic Operation
- 7.4 Changing the Output 3 Alarm Jumper
- 7.4 Using Alarms
- 7.6 Error Code E1 and E2 Messages
- 7.7 Error Code Actions

## Chapter 8

### Applications

- 8.1 Burst Fired, Zero Cross Output
- 8.2 Retransmit
- 8.3 Dead Band
- 8.3 Transmitter Power Supply

## Appendix

- A.1 Warranty and Returns
- A.2 Glossary
- A.5 Index
- A.7 Prompt Index
- A.8 Specifications
- A.9 Ordering Information
- A.10 Declaration of Conformity

# Notes

# Introduction

## Starting Out With the Watlow Series 998

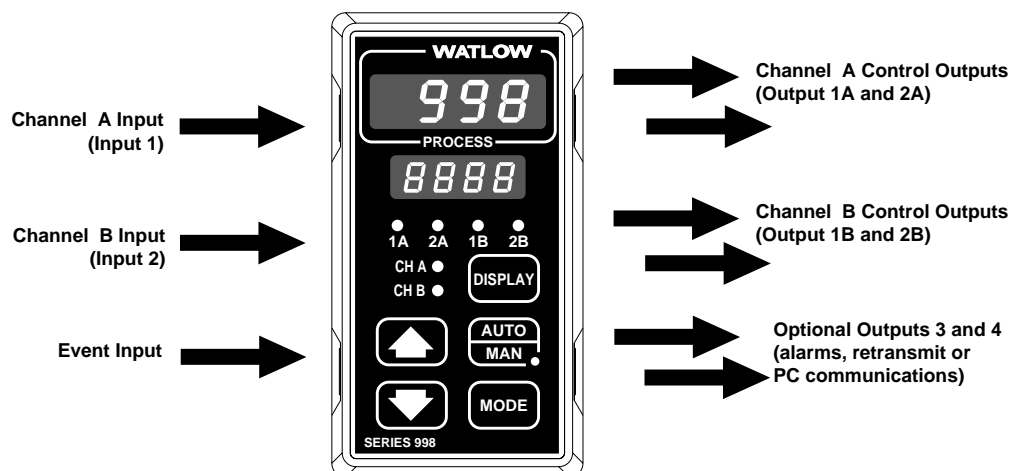

Figure i -  
The Series 998.

Watlow's Series 998 process controller is capable of two independent channels of process control. Each channel can be configured and tuned separately. Each alarm option (outputs 3 and 4) can be used to trigger an alarm based on either channel. The retransmit option, available on output 3, can be used to retransmit the process or set point value of either channel. The digital communications option can be used to configure and monitor the controller with a personal computer from a remote location.

If you are unfamiliar with general controller operation, it's a good idea to read through the entire manual. The manual is organized in setup order, with chapters on wiring, menus, operation and applications. If you understand the concept of process/temperature controls and feel comfortable skipping around through the manual, use the black tabs at the top of each page to quickly scan the pages and find the topic needed. The Menu Overview on the next page is a great place to start. Also, refer to Chapter 3 for information on the keys and displays.

The menu map is an overview of all menus and prompts and how to navigate between them. There are three main menu sets: Setup menus **SET**; Operation menus **OPER**; and Factory menus **FcT9**. You can return to the Display Loop from anywhere by pressing the Display key. DIP switch locations and settings are explained later in Chapter 1.

## Display Loop

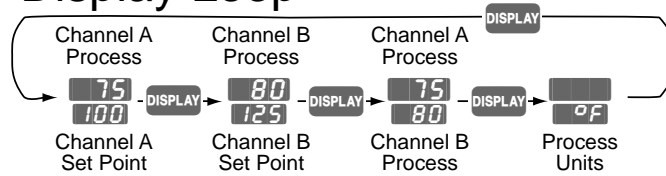

From the Display Loop, press the Mode key **MODE** to reach the Operation menus.

To return to the Display Loop from any point in any menu, press the Display key **DISPLAY**.

From the Display Loop, press both the Up-arrow and Down-arrow keys **▲** and **▼** for three seconds to reach the Setup menus. Hold them down for another three seconds to reach the Factory menus.

## Operation Menus

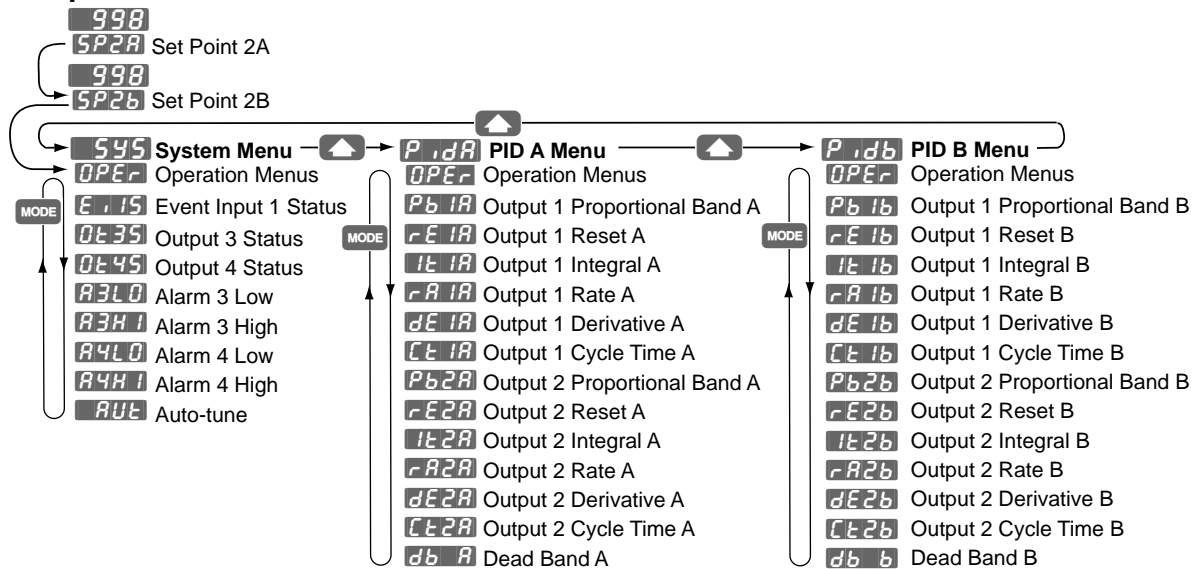

From the Setup menus, press both the Up-arrow and Down-arrow keys  and  for three seconds to reach the Factory menus.

To return to the Display Loop from any point in any menu, press the Display key .

## Setup Menus

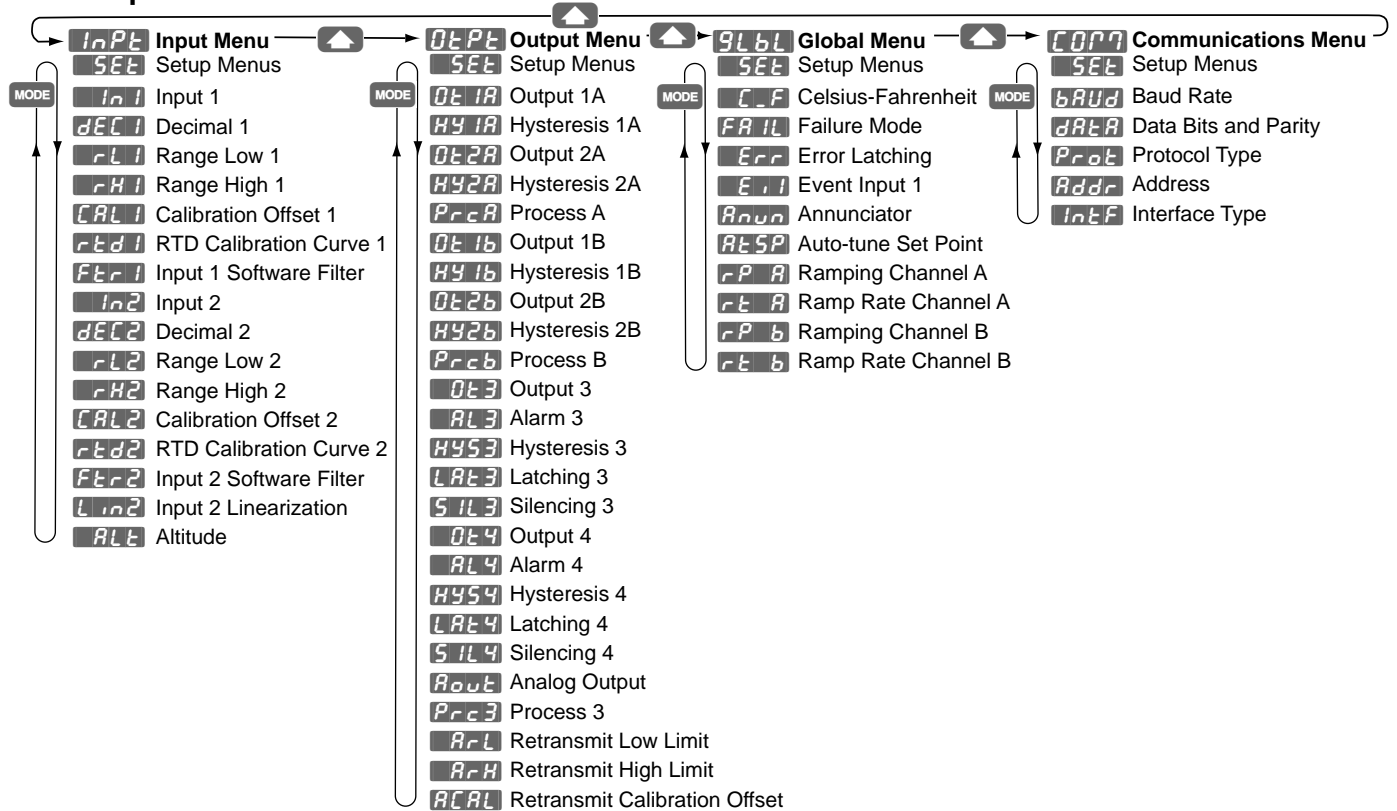

## Factory Menus

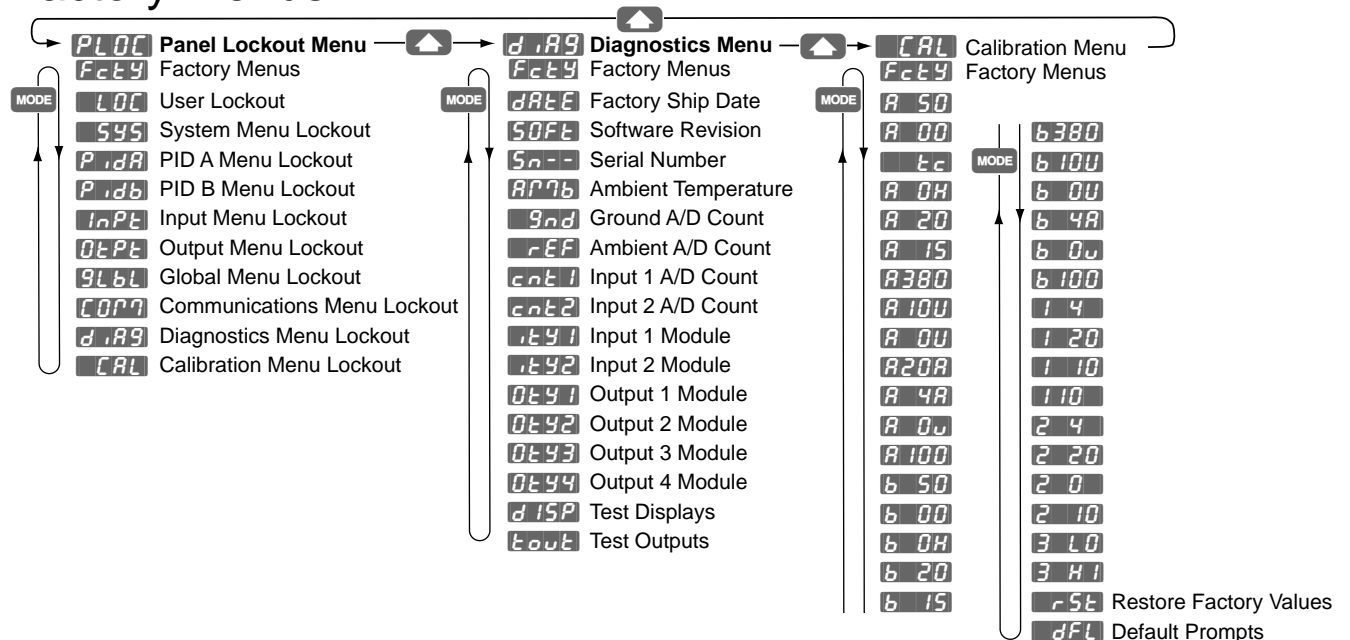

# Notes



# Chapter 1 Hardware Setup

## DIP Switch Locations and Functions

The Watlow Series 998 has at least one and as many as six dual in-line package (DIP) switches inside the controller, depending on the model number. They allow users to configure the controller for a variety of input sensors, to provide power for external signal conditioners or to lockout front panel access to some functions.

To set any DIP switch:

- Remove the controller from the case by pressing firmly on the two release tabs on one side or the top of the bezel until they unsnap. Then firmly press the two release tabs on the opposite side or the bottom of the control until they unsnap. You will need to gently rock the bezel back and forth to release it from the chassis.
- Use the illustrations on the following pages to locate and set each DIP switch.

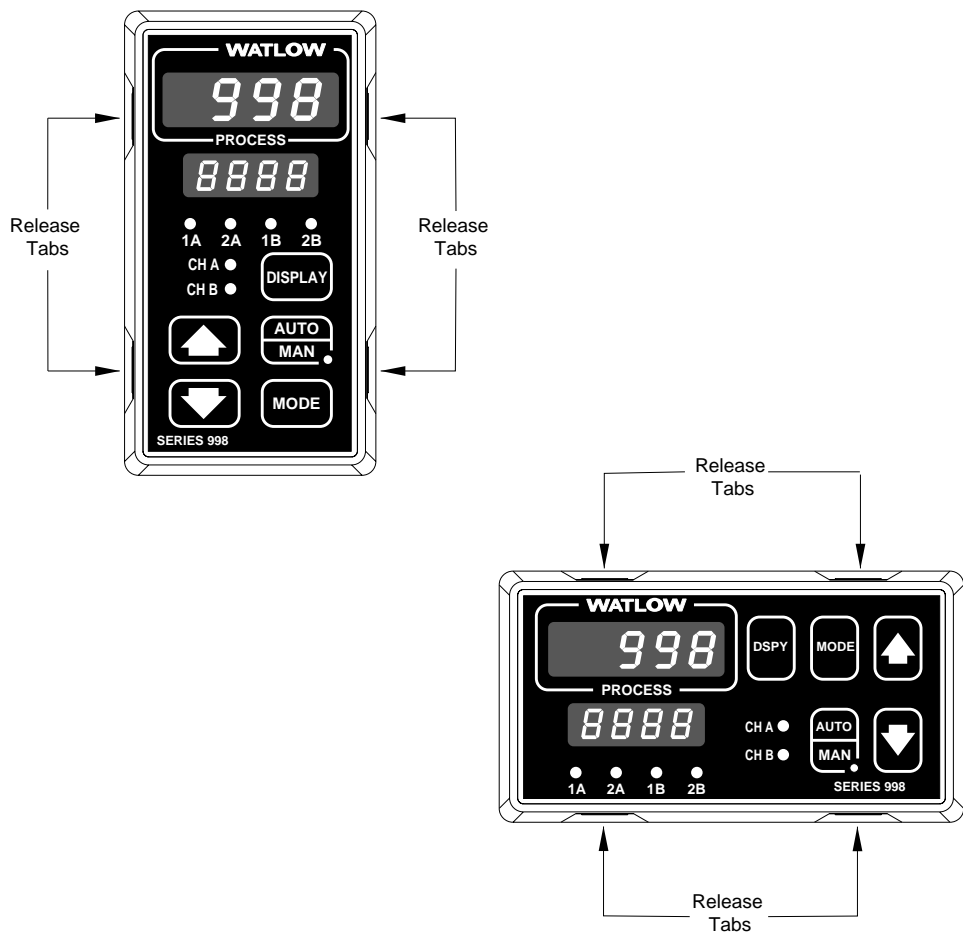
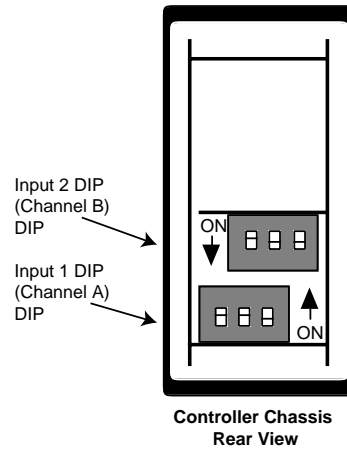

Figure 1.1 - Press the release tabs to remove the controller chassis.

# DIP Switches

1 - Set the input DIP switches to match the sensors you are using in your application. Only controllers with model number 99\_\_ - 22\_\_ - \_\_\_\_ have input DIP switches.

**NOTE:**  
The input 2 DIP switch is mounted upside down.



**Input 1 (Channel A)    Input 2 (Channel B)**  
(99\_\_ - 2\_\_ - \_\_\_\_)    (99\_\_ - 2\_\_ - \_\_\_\_)

**NOTE:**  
Only controllers with the indicated model numbers have these DIP switches.

RTD

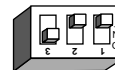
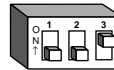

thermocouple: R, S or B

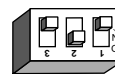
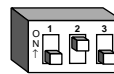

thermocouple: J, K, T, N, E, C, D, Pt2

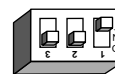
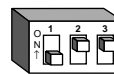

**Figure 1.2 -**  
Input DIP switches.

0-20 or 4-20mA; 0-5, 1-5 or 0-10V

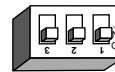
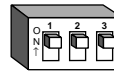

# DIP Switches

2 - Set DIP switches for outputs equipped with an external signal conditioner power supply. Only controllers with model number 99\_\_-\_\_-T\_\_ or 99\_\_-\_\_-T\_\_ have an external signal conditioner power supply.

**NOTE:**  
For other voltages or current settings contact the factory.

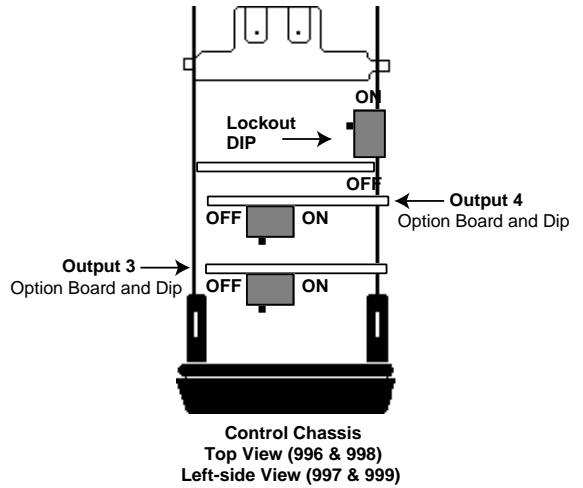

**NOTE:**  
Only controllers with the indicated model numbers have these DIP switches.

**Output 3**                      **Output 4**  
(99\_\_-\_\_-T\_\_)                      (99\_\_-\_\_-T\_\_)

20V ± 5% @ 30mA



12V ± 5% @ 30mA



5V ± 5% @ 30mA



**Figure 1.3 -**  
External signal conditioner power supply DIPs.

3 - When the DIP switches are set, gently insert the controller chassis into the case and push it firmly into place until all four tabs snap into place.

# DIP Switches



**CAUTION:**  
 The lockout DIP switch makes the Setup and Factory menus unavailable. Configure all the Setup and Factory menus before locking them out. Failure to do so could result in damage to equipment in the event of a setup error.

4 - The lockout DIP switch hides the Setup Menu (Input, Output, Global and Communications) and the Factory Menu (Panel Lockout, Diagnostics and Calibration). All units have a lockout DIP switch.

All controllers leave the factory with both switches set to off.

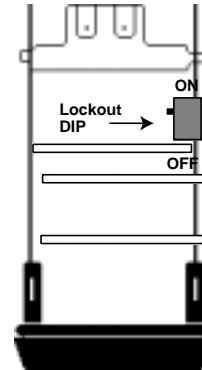

Control Chassis  
 Top View (996 & 998)  
 Left-side View (997 & 999)

no hardware lockout  
 (Switch 1 has no effect.)

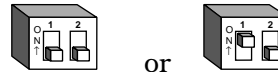

lockout Setup and Factory menus  
 (Switch 1 has no effect.)

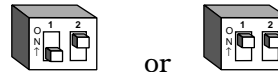
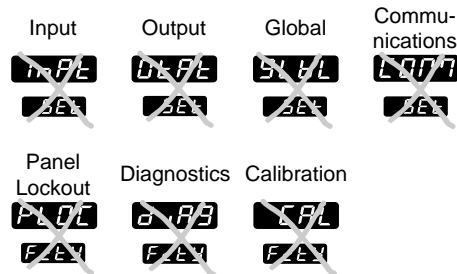
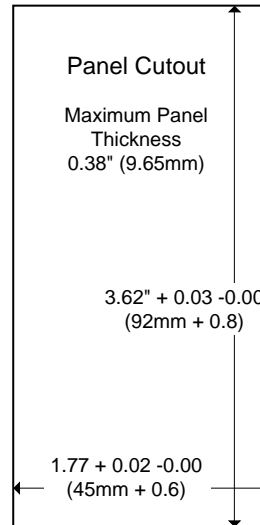

Figure 1.4 -  
 Lockout DIP switch.



# Chapter 2 Installation and Wiring

**NOTE:**  
A minimum of 1.66" (42.2mm) spacing between panel cutouts is recommended.



**Figure 2.1a - Series 998 Panel Cutout Dimensions.**

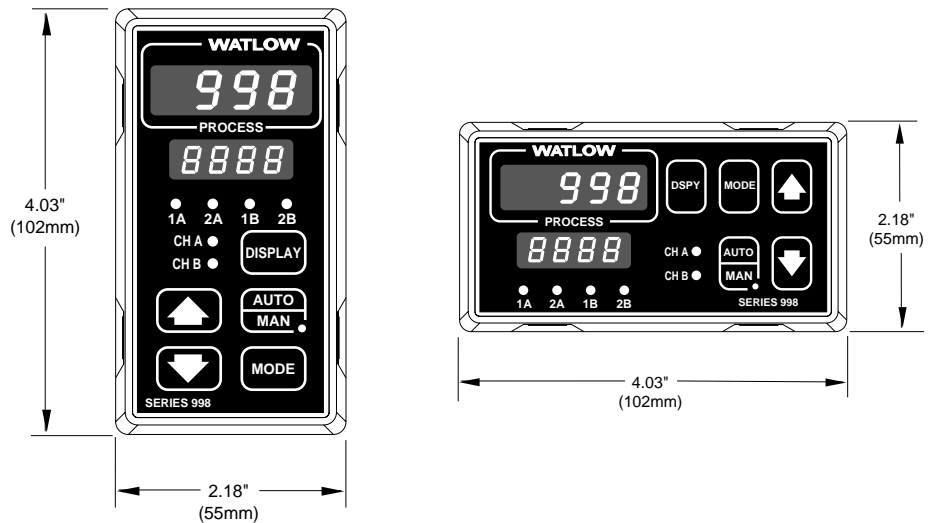

**NOTE:**  
Adjustable mounting brackets can also be side mounted.

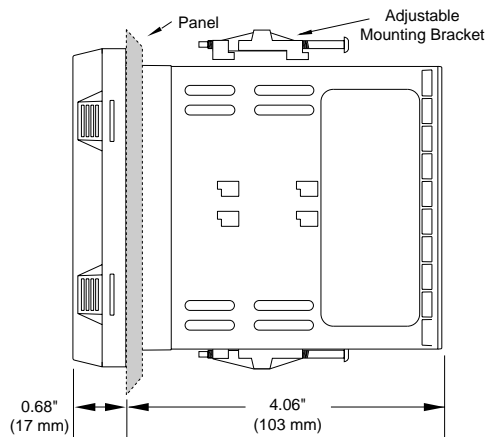

**Figure 2.1b - Series 998 Dimensions.**

## Installing the Series 998

Installing and mounting requires access to the back of the panel.

**NOTE:**

**Removing the controller chassis from its case makes mounting easier.**

1. Make a panel cutout.
2. To remove the controller chassis from its case, press in firmly on the two tabs on one side or the top of the bezel until they unsnap, then unsnap the two tabs on the opposite side or the bottom. Pull the chassis out of the case by gently rocking it.
3. Slide the case into the panel cutout. Check to see that the gasket is not twisted, and is seated within the case bezel flush with the panel. Slide the mounting collar over the back of the control.

**Figure 2.2 -**  
Side and top view.

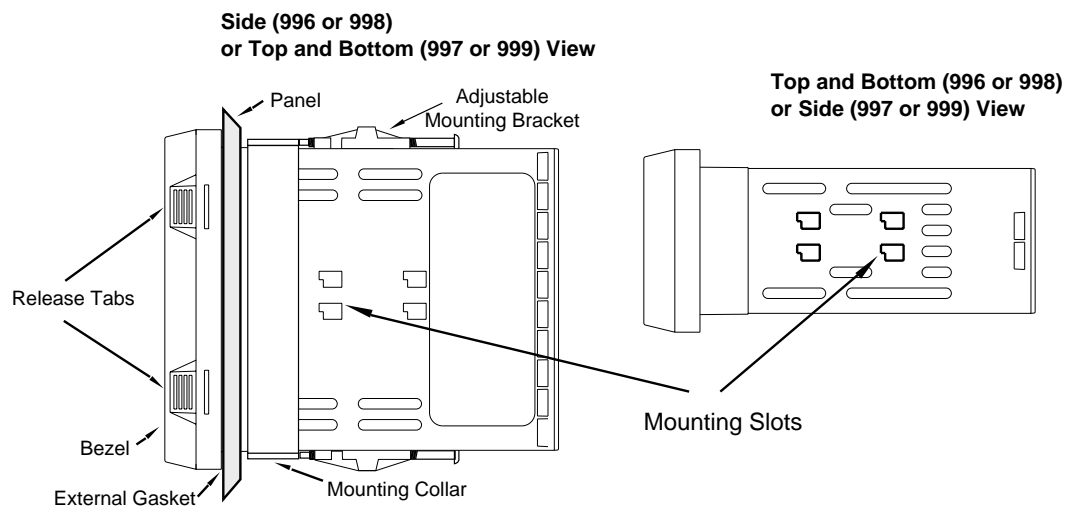



**CAUTION:**  
Follow the installation procedure exactly to guarantee a proper NEMA 4X seal. Make sure the gasket between the panel and the rim of the case is not twisted and is seated properly. Failure to do so could result in damage to equipment.

4. Loosen the mounting bracket screws enough to allow for the mounting collar and panel thickness. Place each mounting bracket into the mounting slots (head of the screw facing the back of the controller). Push each bracket backward then down to secure it to the control case. **To guarantee a proper NEMA 4X seal, Series 996 and 998 units (vertical) must have the mounting brackets located on either side of the unit. When installing Series 997 and 999 units (horizontal) the brackets must be on the top and bottom of the unit.**
5. Make sure the case is seated properly. Tighten the installation screws firmly against the mounting collar to secure the unit. **To ensure a NEMA 4X seal, there should be no space between the bezel and panel.** Overtightening the screws will distort the case and make it difficult to remove or replace the controller.
6. Insert the controller chassis into its case and press the bezel until all four tabs snap. Make sure the inside gasket is seated properly and not twisted.
7. To release the mounting brackets, loosen the mounting bracket screws and push the brackets forward, then pull it up and out.



**WARNING:**  
To avoid potential electric shock, use National Electric Code (NEC) safety practices when wiring and connecting this unit to a power source and to electrical sensors or peripheral devices. Failure to do so could result in injury or death.

**NOTE:**  
Input-to-output isolation is defeated when the external signal conditioner power supply is used to power a transmitter connected to input 1 or input 2.

Figure 2.4 - Power wiring.

## Wiring the Series 998

Wiring options depend on the model number and DIP switch settings. Check the terminal designation stickers on either side of the controller and compare your model number to those shown here and with the model number breakdown on the inside back cover of this manual.

## Input-to-output Isolation

The Series 998 uses optical isolation between the analog inputs and the controller outputs/digital input. This isolation provides a 500V $\bar{A}$  (ac) barrier to prevent ground loops when using grounded sensors and/or peripheral equipment.

Here is a breakdown of the isolation barriers:

- Analog inputs 1 and 2 are grouped together.
- Outputs 1 through 4 and the standard event input are grouped together. This does not apply to Output 4 when configured as communications.
- The digital communications output (4) is separate from the above groups.

## Power Wiring

**100 to 240V $\sim$  (ac) nominal, (85 to 264 actual)**

Vertical Package	99	<u>8</u>	-	-	-	-	-	-	-
Horizontal Package	99	<u>9</u>	-	-	-	-	-	-	-

**24 to 28 V $\approx$  (ac/dc) nominal, (20 to 30 actual)**

Vertical Package	99	<u>6</u>	-	-	-	-	-	-	-
Horizontal Package	99	<u>7</u>	-	-	-	-	-	-	-

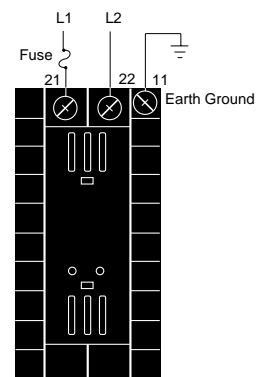

## Sensor Installation Guidelines

**Thermocouple input:** Extension wire for thermocouples must be of the same alloy as the thermocouple itself to limit errors.

Using grounded thermocouples for both input 1 and input 2 may create ground loop problems. To correct this problem, replace at least one of the grounded thermocouples with an ungrounded thermocouple. If the application requires grounded thermocouples, use an isolated transmitter, such as a Watlow Gordon 5702 isolated transmitter.

**RTD input:** Each 1 $\Omega$  of lead wire resistance can cause a +2 $^{\circ}$ F error when using a two-wire RTD. A three-wire RTD sensor overcomes this problem. All three wires must have the same electrical resistance (i.e., same gauge, same length, multi-stranded or solid, same metal).

Maintain isolation between input 1 and input 2 to prevent a ground loop. A ground loop may cause incorrect readings, dashes across the upper display or the display of error codes.

**Process input:** Isolation must be maintained between input 1 and input 2. If both input 1 and input 2 are used as process inputs, a separate power supply and transmitter must be used for each input. Output option T (external signal conditioner power supply) can be used to supply power for only one input.



**CAUTION:**  
The Series 998 will not function with two grounded thermocouple inputs. Avoid using a grounded thermocouple for both input 1 and input 2. Failure to follow this guideline could result in damage to equipment.



## Event Input 1

**Standard on all units**

14 - 36V $\overline{=}$  (dc) Event Input 1 off (open)

0 - 3V $\overline{=}$  (dc) Event Input 1 on (closed)

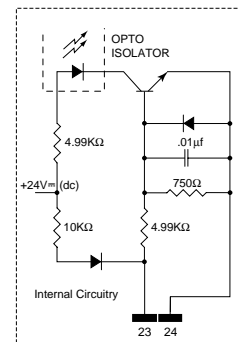
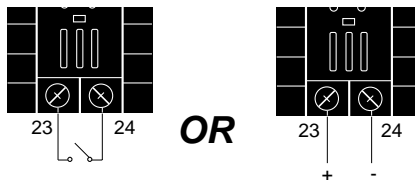

## Wiring 0-20 and 4-20mA Process Inputs

Certain “transmitters” used in process input applications are producing internal resistor failures in the Watlow Series 988 family of controllers. This is only apparent with the Series 988 family 1/8 DIN units with Process Inputs selected (0-20mA or 4-20mA dc only).

We are noticing that an external resistor is required to prevent a high in-rush current which burns out the Series 988 family controllers’ 7-ohm internal resistor. This high in-rush current occurs initially on “power-up.” If the transmitter turns full on for a split second during power-up, the available current weakens or damages the internal resistor.

Example:  $20V / 7 \text{ ohms} = 2,857mA$  (too much!).

The wiring diagram example below shows an application where a customer is using a 4-20mA dc transmitter and power supply to feed the input of a Series 988 controller. The Rx range (100 to 400 ohms) for the external resistor is recommended. We suggest starting with 250 ohms.

Example: Customer is using a 24V $\hat{=}$  (dc) power supply to power up the 4-20mA dc transmitter that inputs to the Series 988 terminals 8 (-) and 10 (+). To figure out what the internal Series 988’s handling current is for the 0-20mA or 4-20mA dc input to the Series 988 controllers, we need to apply Ohm’s Law: The square root of Watts divided by Resistance equals Current. Applying that formula to the example below produces the following: Square Root of  $(0.125 \text{ Watts} / 7 \text{ ohms}) = 134 \text{ mA dc}$  (handling input current). This is the acceptable input current for the Series 988 universal input board.

**Figure 2.5 - Process wiring example.**

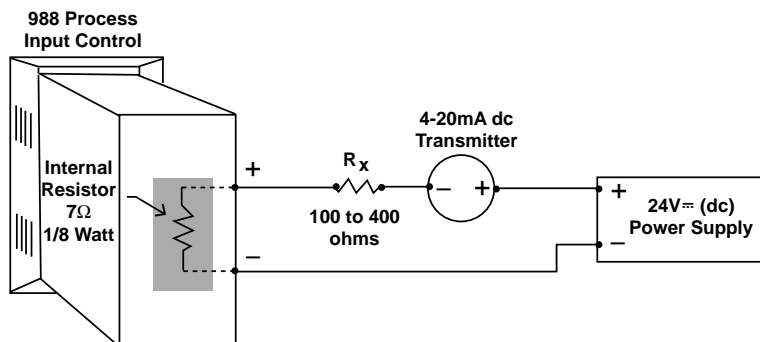

Reminder, the input impedance of 7 ohms handles the majority of our customer applications; the external resistor (Rx) is only for certain transducers/transmitters that spike on power-up or power-down. Please make sure your customer’s transmitter / transducer fall within our Series 988 family (1/8 DIN) of controllers’ Process Input specification of 7 ohms input impedance.

# Wiring Example

Figure 2.6 - System Wiring Examples.

**WARNING:**  
To avoid potential electric shock, use National Electric Code (NEC) safety practices when wiring and connecting this unit to a power source and to electrical sensors or peripheral devices. Failure to do so could result in injury or death.

**CAUTION:**  
To avoid damage to property and equipment, use National Electric Code (NEC) standard wiring practices to install and operate the series 998. Failure to do so could result in such damage.

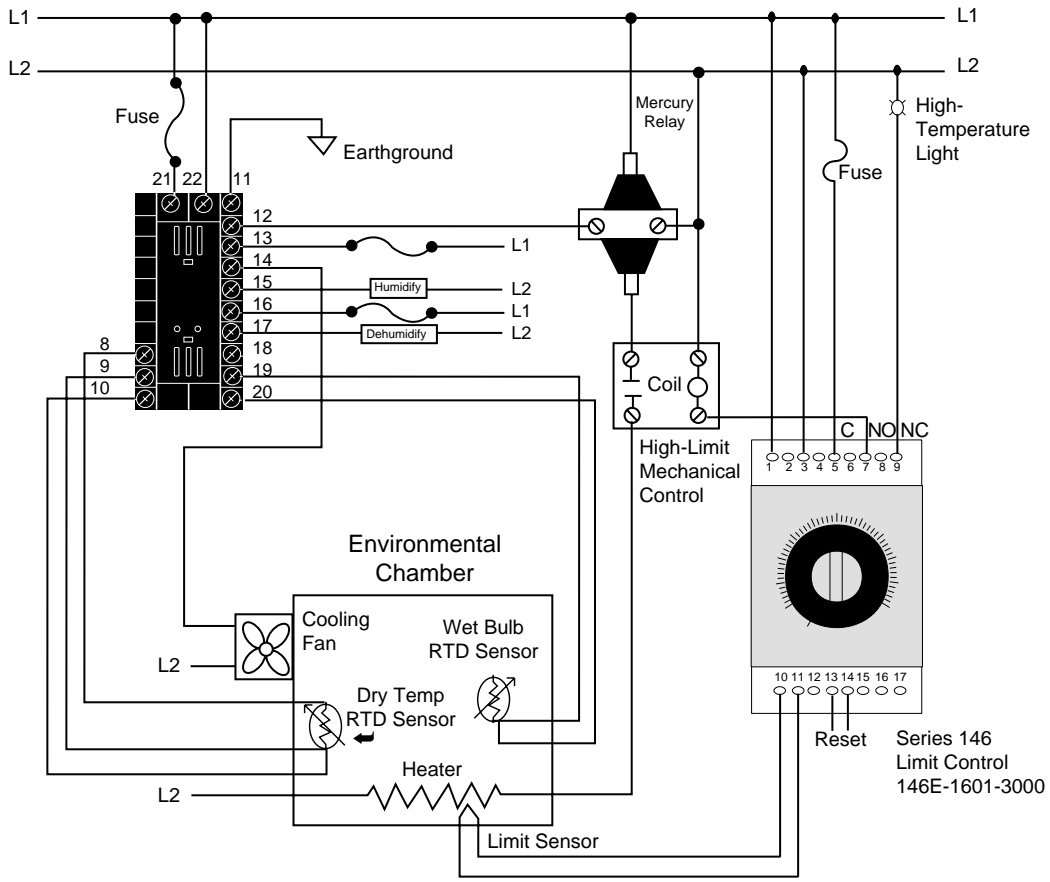



**WARNING:**  
To avoid damage to property and equipment, and/or injury or loss of life, use National Electric Code (NEC) standard wiring practices to install and operate the Series 998. Failure to do so could result in such damage, and/or injury or death.

**NOTE:**  
Sketch in your application on this page or a copy of it. See wiring examples in this chapter and in the Appendix.

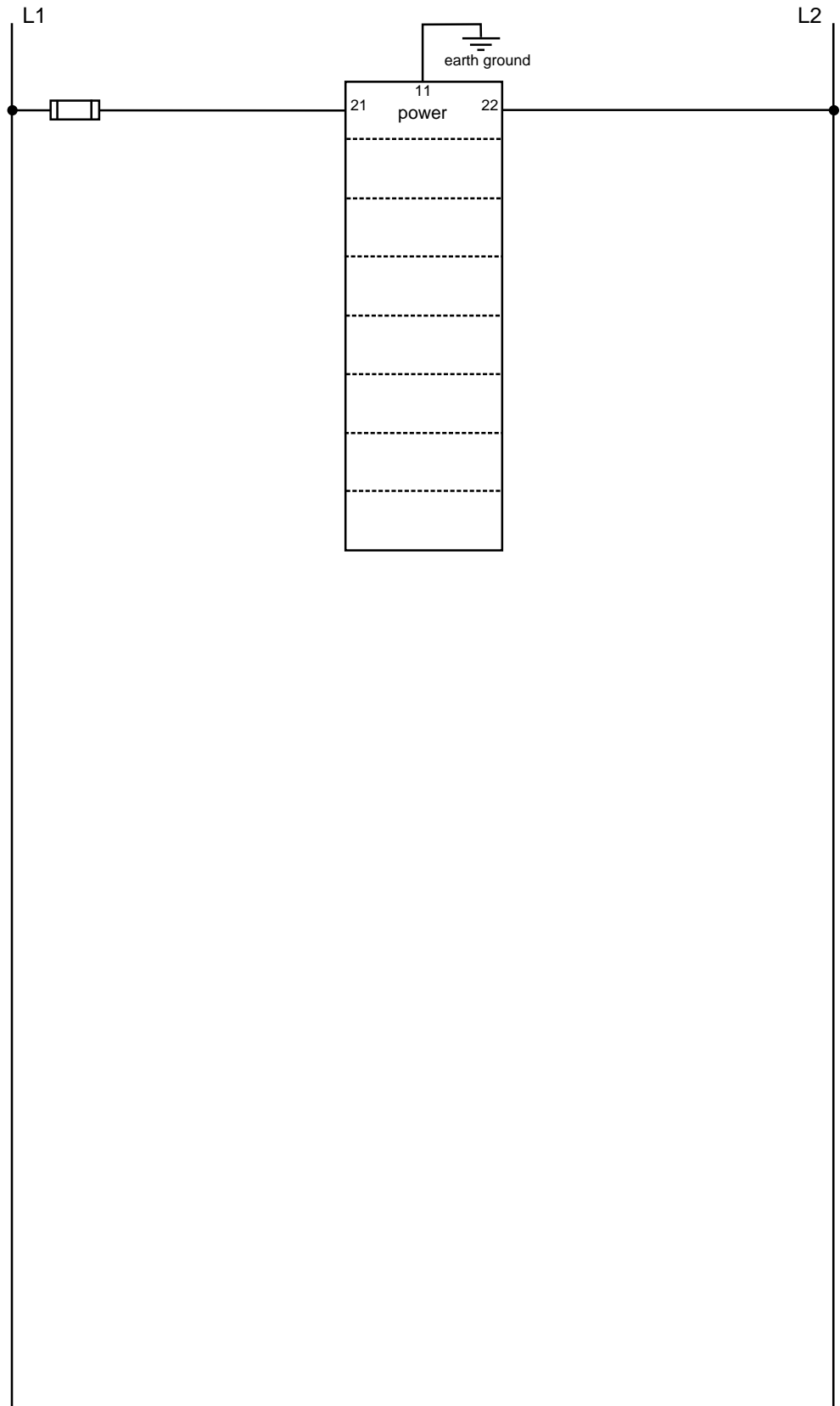

Figure 2.7 -  
Wiring notes.

# Channel A Input Wiring

**NOTE:**  
Using a grounded thermocouple for both input 1 and input 2 can cause ground loop problems.

**Figure 2.8a — Thermocouple**

Thermocouple only  
99 \_\_\_ - 1 \_\_\_ - \_\_\_ - \_\_\_

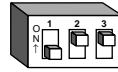

**J, K, T, N, C, E, Pt2, D**  
Dip Switch Setting

Universal signal conditioner  
99 \_\_\_ - 2 \_\_\_ - \_\_\_ - \_\_\_

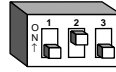

**R, S, B**  
Dip Switch Setting

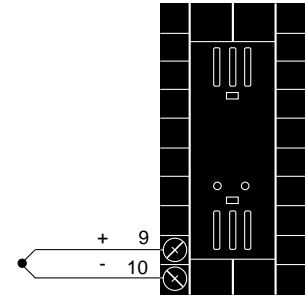

**NOTE:**  
Model number  
99\_\_-1\_\_\_-\_\_\_-\_\_\_  
has no input 1 DIP  
switch.

**Figure 2.8b — RTD, 2- or 3-wire**

Universal signal conditioner  
99 \_\_\_ - 2 \_\_\_ - \_\_\_ - \_\_\_

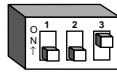

**Dip Switch Setting**

**Jumper 9 to 10  
for 2-wire RTD**

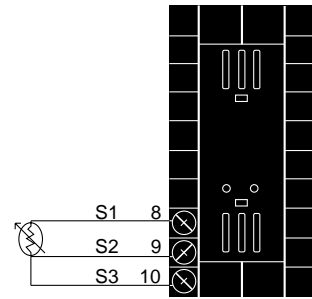
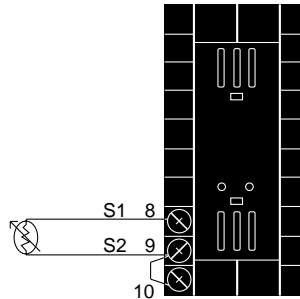

**Figure 2.8c — 0-5V<sub>DC</sub>, 1-5V<sub>DC</sub> or 0-10V<sub>DC</sub> (dc) Process**

Universal signal conditioner  
99 \_\_\_ - 2 \_\_\_ - \_\_\_ - \_\_\_

**Input impedance: 10K $\Omega$**

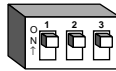

**Dip Switch Setting**

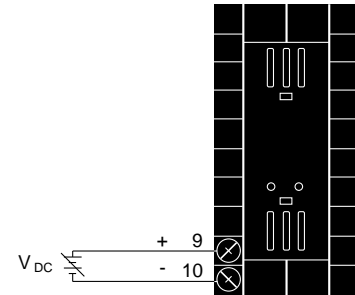

**CAUTION:**  
An external resistor  
is required for  
0-20mA and 4-20mA  
process wiring to  
prevent a high in-  
rush current which  
could burn out the  
controller's 7-ohm  
resistor. See page  
2.4. for recommen-  
dations.

**Figure 2.8d — 0-20mA or 4-20mA Process**

Universal signal conditioner  
99 \_\_\_ - 2 \_\_\_ - \_\_\_ - \_\_\_

**Input impedance: 7 $\Omega$**

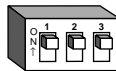

**Dip Switch Setting**

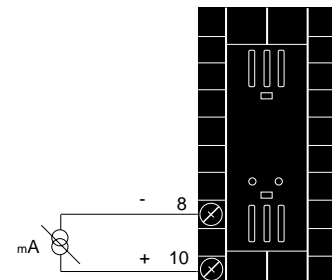

# Channel B Input Wiring

**NOTE:**  
Using a grounded thermocouple for both input 1 and input 2 can cause ground loop problems.

**Figure 2.9a — Thermocouple**

Thermocouple only

99 \_ \_ - 1 \_ \_ - \_ \_ \_

Universal signal conditioner

99 \_ \_ - 2 \_ \_ - \_ \_ \_

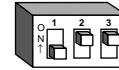

J, K, T, N, C, E, Pt2, D  
Dip Switch Setting

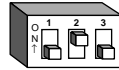

R, S, B  
Dip Switch Setting

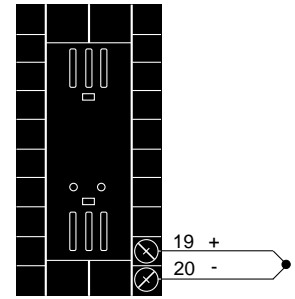

**NOTE:**  
Model number 99 \_ \_ - 1 \_ \_ - \_ \_ \_ has no In1 DIP switch.

**Figure 2.9b — RTD, 2- or 3-wire**

99 \_ \_ - 2 \_ \_ - \_ \_ \_

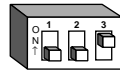

Dip Switch Setting

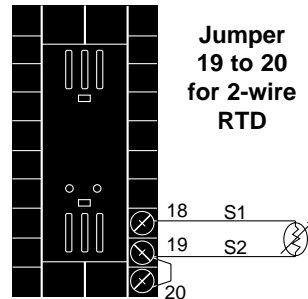

Jumper 19 to 20 for 2-wire RTD

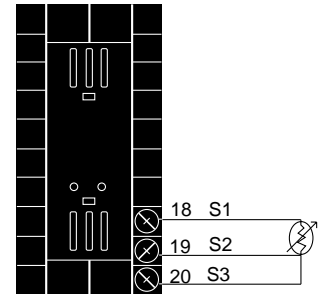

**Figure 2.9c — 0-5V<sub>DC</sub> , 1-5V<sub>DC</sub> , 0-10V<sub>DC</sub> (dc) Process**

99 \_ \_ - 2 \_ \_ - \_ \_ \_

Input impedance: 10KΩ

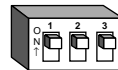

Dip Switch Setting

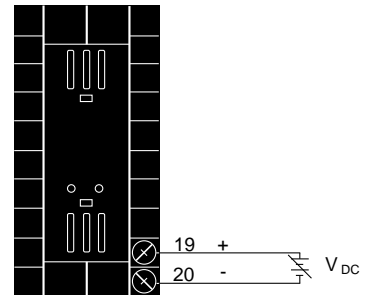

**CAUTION:**  
An external resistor is required for 0-20mA and 4-20mA process wiring to prevent a high in-rush current which could burn out the controller's 7-ohm resistor. See page 2.4. for recommendations.

**Figure 2.9d — 0-20mA or 4-20mA Process**

99 \_ \_ - 2 \_ \_ - \_ \_ \_

Input impedance: 7Ω

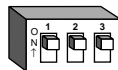

Dip Switch Setting

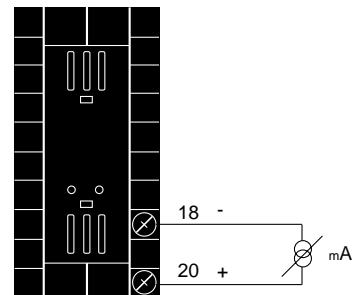

# Channel A Output Wiring

**Figure 2.10a — AC Outputs**

- **Dual Electromechanical Relays without Contact Suppression**  
Dual Form A, 2 Amps  
Off-state impedance: 31MΩ

99 \_ \_ - \_ \_ E \_ - \_ \_ \_ \_

- **Dual Solid-state Relay without Contact Suppression**  
Dual Form A, 0.5 Amps  
Off-state impedance: 31MΩ

99 \_ \_ - \_ \_ K \_ - \_ \_ \_ \_

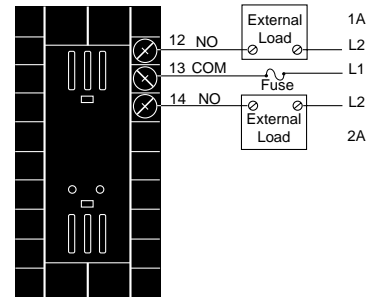

**Figure 2.10b — Dual Switched DC**

99 \_ \_ - \_ \_ C \_ - \_ \_ \_ \_

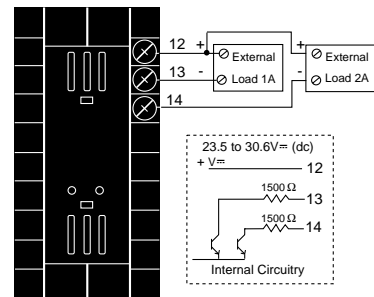

**Figure 2.10c — 0-20mA and 4-20mA Process**

Load impedance: 800Ω max.

99 \_ \_ - \_ \_ E \_ - \_ \_ \_ \_

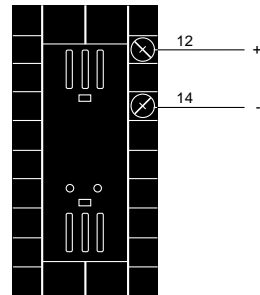

**Figure 2.10d — 0-5V<sub>rms</sub>, 1-5V<sub>rms</sub> and 0-10V<sub>rms</sub> (dc) Process**

Load impedance: 500Ω min.

99 \_ \_ - \_ \_ E \_ - \_ \_ \_ \_

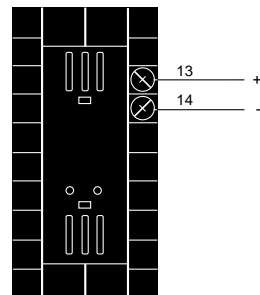

# Channel B Output Wiring

Figure 2.11a — AC Outputs

- **Dual Electromechanical Relay without Contact Suppression**

Dual Form A, 2 Amps  
Off-state impedance: 31MΩ

99 \_ \_ - \_ \_ \_ E - \_ \_ \_ \_

- **Dual Solid-state Relay without Contact Suppression**

0.5 Amps  
Off-state impedance: 31MΩ

99 \_ \_ - \_ \_ \_ K - \_ \_ \_ \_

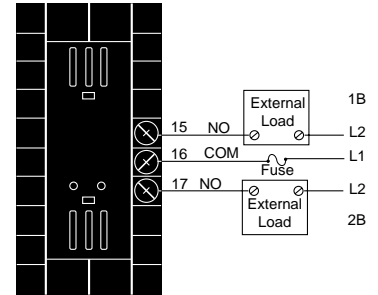

Figure 2.11b — Dual Switched DC

99 \_ \_ - \_ \_ \_ C - \_ \_ \_ \_

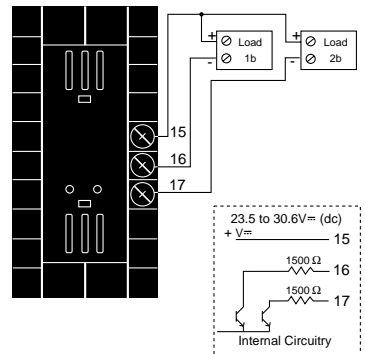

Figure 2.11c — 0-20mA and 4-20mA Process

Load impedance: 800Ω max.

99 \_ \_ - \_ \_ \_ E - \_ \_ \_ \_

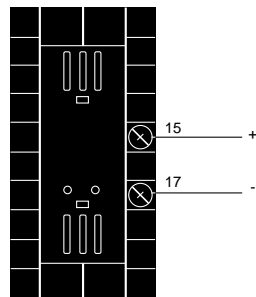
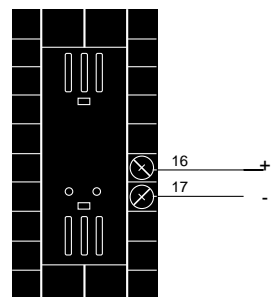

Figure 2.11d — 0-5V<sub>dc</sub>, 1-5V<sub>dc</sub> and 0-10V<sub>dc</sub> Process

Load impedance: 500Ω min.

99 \_ \_ - \_ \_ \_ E - \_ \_ \_ \_



# Output 3 Wiring

**Figure 2.12a — AC Outputs**

- **Solid-state Relay with Contact Suppression**  
0.5 Amps  
Off-state impedance: 20KΩ min.  
99 \_\_\_ - \_\_\_\_\_ - **B** \_\_\_\_\_

- **Electromechanical Relay without Contact Suppression**  
Form A or B, 5 Amps  
Off-state impedance: 31MΩ  
99 \_\_\_ - \_\_\_\_\_ - **J** \_\_\_\_\_

Form A or B  
Alarm Jumper Settings  
(Top View)

- **Solid-state Relay without Contact Suppression**  
0.5 Amps  
Off-state impedance: 31MΩ  
99 \_\_\_ - \_\_\_\_\_ - **K** \_\_\_\_\_

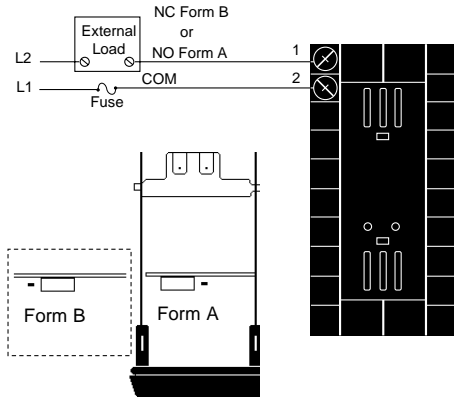

**Figure 2.12b — Switched DC**

Minimum load resistance: 500Ω

- 99 \_\_\_ - \_\_\_\_\_ - **C** \_\_\_\_\_

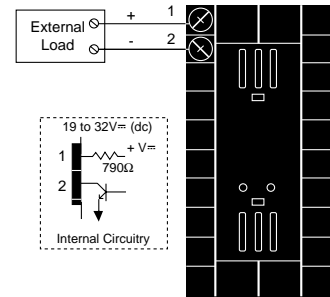

**Figure 2.12c — Process Retransmit**

**0-20mA, 4-20mA**  
Load impedance: 600Ω max.

- 99 \_\_\_ - \_\_\_\_\_ - **M** \_\_\_\_\_

**0-5V<sub>rms</sub>, 1-5V<sub>rms</sub> or 0-10V<sub>rms</sub> (dc)**  
Load impedance: 500Ω min.

- 99 \_\_\_ - \_\_\_\_\_ - **N** \_\_\_\_\_

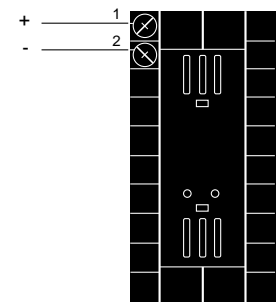

**NOTE:**  
Input-to-output isolation is defeated when the external transmitter power supply is used to power a transmitter connected to input 1 or input 2.

**Figure 2.12d — External Transmitter Power Supply**

- 99 \_\_\_ - \_\_\_\_\_ - **I** \_\_\_\_\_

See Chapter 1 for DIP switch location and settings.

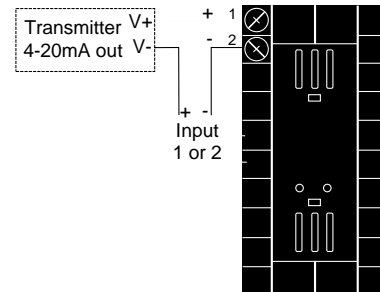



**Figure 2.13a — AC Outputs**

- **Solid-state Relay with Contact Suppression**  
0.5 Amps  
Off-state impedance: 20KΩ min.

99 \_ \_ - \_ \_ \_ \_ \_ - \_ B \_ \_

- **Solid-state Relay without Contact Suppression**  
0.5 Amps  
Off-state impedance: 31MΩ

99 \_ \_ - \_ \_ \_ \_ \_ - \_ K \_ \_

- **Electromechanical Relay with Contact Suppression**  
(On NO and COM contacts only)  
Form C, 5 Amps  
Off-state impedance: 20KΩ min.

99 \_ \_ - \_ \_ \_ \_ \_ - \_ D \_ \_

- **Electromechanical Relay without Contact Suppression**  
Form C, 5 Amps  
Off-state impedance: 31MΩ

99 \_ \_ - \_ \_ \_ \_ \_ - \_ E \_ \_

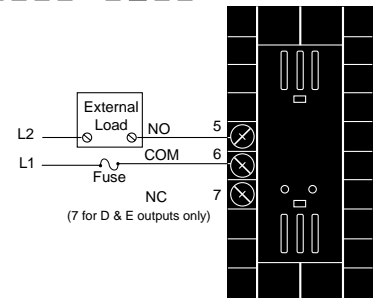

**Figure 2.13b — Switched DC, Open Collector**

- Minimum load resistance: 500Ω

99 \_ \_ - \_ \_ \_ \_ \_ - \_ C \_ \_

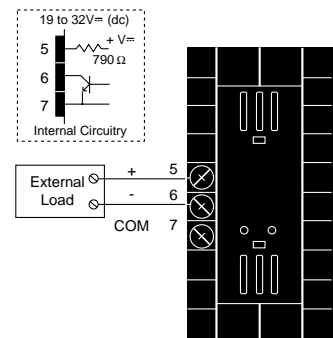

**Figure 2.13c — External Transmitter Power Supply**

99 \_ \_ - \_ \_ \_ \_ \_ - \_ I \_ \_

See Chapter 1 for DIP switch location and settings.

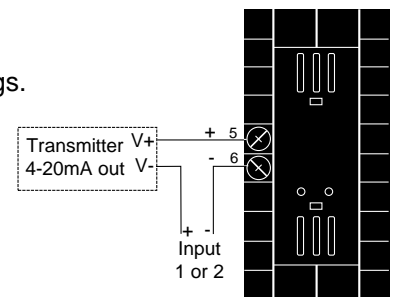

**NOTE:**  
Input-to-output isolation is defeated when the external transmitter power supply is used to power a transmitter connected to input 1 or input 2.

**For data communications wiring refer to *How to Use Data Communications with the Watlow Series 988 Family Controls.***

# Notes

# Chapter 3 Keys and Displays

## Upper Display

Indicates either actual process value for channel A or channel B, the operating prompt values, or error codes. When powering up, the display will be blank for 3 seconds. Red or green, 0.4" (10mm) high, seven-segment, four-digit LED display.



## CH A Indicator Light

When lit, if the CH B light is not on, the channel A process value is shown in the upper display and the channel A set point value is shown in the lower display. When both CH A and CH B lights are on, the upper display shows the channel A process value and the lower display shows the channel B process value.



## CH B Indicator Light

When lit, if the CH A light is not on, the channel B process value is shown in the upper display and the channel B set point value is shown in the lower display. When both CH A and CH B lights are on, the upper display shows the channel A process value and the lower display shows the channel B process value.

## Up-arrow Key

Increases the value of the displayed prompt. A light touch increases the value by one. Holding the key down increases the value at a rapid rate. New data does not take effect for five seconds or until the Mode  or Display  key is pressed.

## Down-arrow Key

Decreases the value of the displayed prompt. A light touch decreases the displayed value at a rapid rate. New data does not take effect for five seconds or until the Mode  or Display  key is pressed.

## Up-arrow + Down-arrow Keys

Press simultaneously for three seconds to enter the Setup Menu. Continue to press both keys for another three seconds to enter the Factory Menu.

## Lower Display

Indicates the channel A or channel B set point, or channel B process value, menu prompts, or alarm codes. Red or green, 0.3" (8mm) high, seven-segment, four-digit LED display.

## 1A, 2A, 1B, 2B Indicator Lights

These lights indicate when output 1A, 2A, 1B or 2B is active.

## Display Key

The Display key is used to select which channel A and/or B parameter to displayed. On initial power-up the upper display shows the channel A process value and the lower display shows the channel A set point value and the CH A light is on. One press of the Display key lights CH B and the upper display shows the channel B process value and the lower display shows the channel B set point value. A second press of the key lights both CH A and CH B, and the upper display shows the channel A process value and the lower display shows the channel B process value. See the next page for

more information on the Display Loop.

## Auto/Man Key

Used to switch from auto to manual control or vice versa. Also used to reset alarms.

## Mode Key

Steps the control through the menus. New data is entered once the Mode key is pressed.

## Mode+Up-arrow Key

To move backwards through the menus, hold down the Mode key, then press the Up-arrow key to scroll. The Mode key must be pressed first and held before the Up-arrow key will begin scrolling. Scrolling is disabled once the keys are released or you reach the top of the menu.

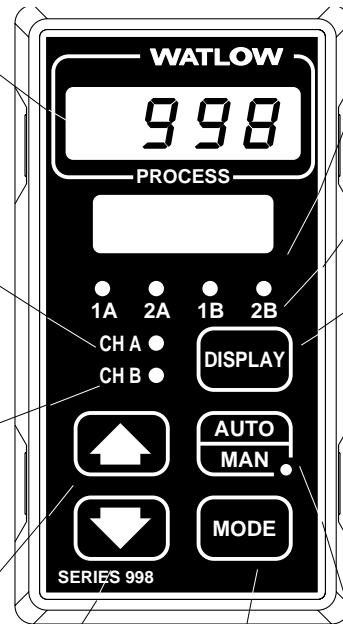

Figure 3.1 - Series 998 Keys and Displays.

# Display Loop

**NOTE:**  
Lower display alternately flashes **rP** and lower display value when ramping is in process.

## Display Key and Loop

On power up, the Series 998 displays the channel A set point value in the lower display and the channel A process value in the upper display and the CH A (channel A) indicator light is on. Press the Display key once to view the channel B set point and process values (CH B will be lit). Press the Display key once again and channel A process value is displayed in the upper display and channel B process value is displayed in the lower display. At this point, both CH A and CH B will be lit. Press the Display key again to display units.

Any point in any menu, if no key is pressed for one minute the display returns to displaying the channel A process and set point.

## Display Loop

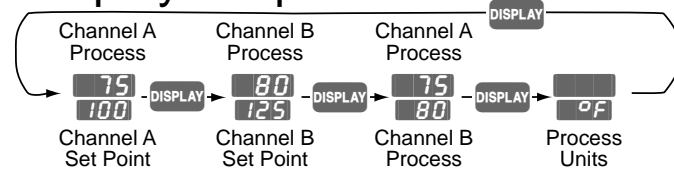

Figure 3.2 - The Display Loop.

## Display Loop Parameters

**Channel A Process and Set Point:** The channel A process value is shown in the upper display. The set point is shown in the lower display, it sets the operating set point for the channel A control outputs. If channel A is in manual mode the set point is in percent output.

Range: **rL1** to **rH1** in auto mode  
**-100** % to **100** % in manual mode (heat/cool)  
**0** % to **100** % in manual mode (heat only)  
**-100** % to **0** % in manual mode (cool only)

Default: depends on input 1 range and type

**Channel B Process and Set Point:** The channel B process value is shown in the upper display. The set point is shown in the lower display, it sets the operating set point for the channel B control outputs. If channel B is in manual mode the set point is in percent output.

Range: **rL2** to **rH2** in auto mode  
**-100** % to **100** % in manual mode (heat/cool)  
**0** % to **100** % in manual mode (heat only)  
**-100** % to **0** % in manual mode (cool only)

Default: depends on input 2 range and type

**Process A and Process B:** The channel A process value is displayed in the upper display with channel B process value displayed in the lower display.

Range: depends on input types

Default: none

**Units:** Shows the units associated with the temperature value. This parameter shows what the **C-F** (Global Menu) is set to.





Range: **OF** or **OC**

Default: none

Hidden if: input 1 and input 2 are process inputs

# Chapter 4 The Setup Menus

## Navigating the Setup Menu



To reach the Setup Menus, begin in the Display Loop and press both the Up-arrow  and Down-arrow  keys for three seconds. The Setup Menu prompt **SEt** will appear in the lower display, and the Input Menu prompt **InPt** will appear in the upper display. The four Setup Menus are: Input **InPt**; Output **OutPt**; Global **GLbL**; and Communications **COmM**. Use the Up-arrow  or Down-arrow  key to select a menu and the Mode key **MODE** to step through a menu. The Communications Menu appears only on units equipped with the data communications option (99\_\_-\_\_-R\_\_ or 99\_\_-\_\_-S\_\_).

**NOTE:**  
Press the Display key **DISP** to return to the Display Loop from any point in any menu.

You will not see every prompt in any of these menus. The unit's configuration and model number determine which prompts appear. After stepping through each menu, the Series 998 returns to the Setup Menu prompt. Use the Up-arrow or Down-arrow key to select the next menu, or use the Mode key to advance through the same menu again. To move backwards through the menu hold the Mode key down and press the Up-arrow key. Use the Up-arrow or Down-arrow key to change the prompt setting.

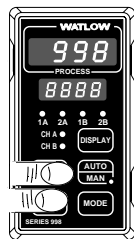
Refer to the Appendix for model number options. For additional information about communications and the communications prompts, refer to the supplemental manual *Data Communications with the Watlow Series 988 Family of Controllers*.



① Begin in the Display Loop, and press the Up-arrow  and Down-arrow  keys simultaneously to reach the Setup menus.

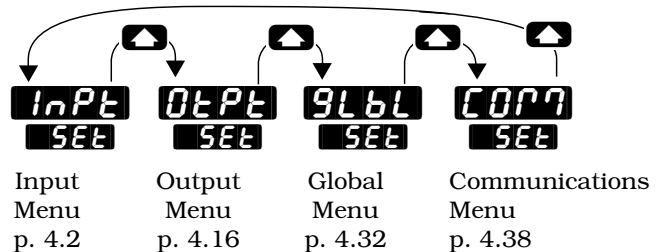

**NOTE:**  
The lockout DIP switch hides the Setup menus. See Chapter 1.

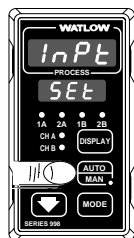

② Press the Up-arrow key  to select one of the Setup menus.

**Figure 4.1 - Navigating the Setup menus.**

# Setup-Input

## Reaching the Input Menu

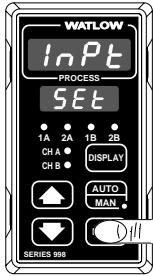

③ Select the Input Menu, then press the Mode key **MODE** to step through the prompts.

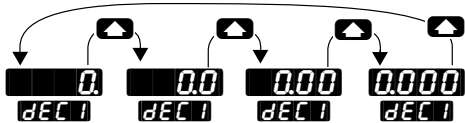

④ Press the Up-arrow key or the Down-arrow key to select one of the prompt values.

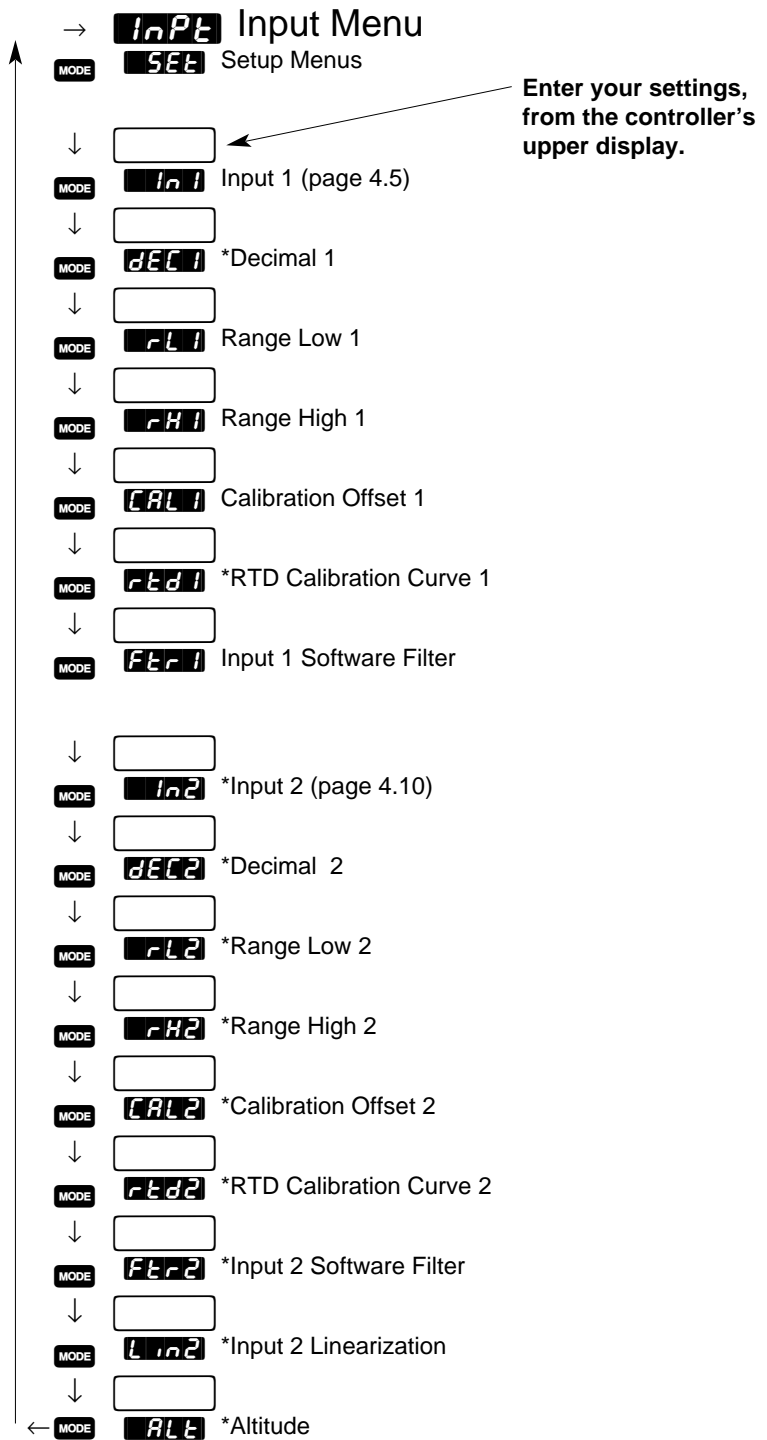

Figure 4.2 - The Input Menu.

\*Prompts may not appear, depending on controller configuration.

## Temperature and Relative Humidity

When the controller will be used to measure temperature and relative humidity, channel A is designated as the temperature channel and channel B is the humidity channel. Any sensor type may be used for either channel A or B. This includes thermocouples, RTDs or process inputs that have been properly scaled to represent a temperature. Below are the three methods for measuring relative humidity with the Series 998.

**Wet Bulb/Dry Bulb** In this configuration, a dry bulb connected to input 1 measures temperature on channel A. A wet bulb input on input 2, in combination with the dry bulb temperature, senses relative humidity on channel B. The Series 998 calculates the temperature difference between the two bulbs to determine percent relative humidity. With a wet bulb/dry bulb configuration, the Input 2 Linearization prompt **LIn2** must be set to **LDb**.

**NOTE:**  
See Input 2  
Linearization  
**LIn2** in this chapter.

The humidify and dehumidify outputs (outputs 1B and 2B) are disabled when the channel A temperature falls below 32°F/0°C, or goes above 212°F/100°C. The relative humidity process display in the Display Loop will display the error code **E2 2** for a low temperature error and **E2 3** if the temperature is above the range high.

**Vaisala Model HMM-30C Solid-state Relative Humidity Sensor** With the Vaisala configuration, channel A is used to measure temperature and channel B must be a process input with the Input 2 Linearization prompt **LIn2** set to **30C**. The Series 998 provides temperature compensation for the Vaisala sensor. The humidify and dehumidify outputs (outputs 1B and 2B) are disabled when the channel A temperature falls below -40°F/-40°C, or goes above 320°F/160°C. The relative humidity process display in the Display Loop will display the error code **E2 2** for a low temperature error and **E2 3** if the temperature is above the range high.

**Rotronic Model H260 Capacitive Relative Humidity Sensor** With the Rotronic configuration, channel A is used to measure temperature and channel B must be a process input with the Input 2 Linearization prompt **LIn2** set to **H250**. The Series 998 provides temperature compensation for the Rotronic sensor.

**NOTE:**  
See Input 2  
Linearization  
**LIn2** in this chapter.

The humidify and dehumidify outputs (outputs 1B and 2B) are disabled when the channel A temperature falls below -5°F/-20°C, or goes above 320°F/160°C. The relative humidity process display in the Display Loop will display the error code **E2 2** for a low temperature error and **E2 3** if the temperature is above the range high.

## Temperature - Temperature



For temperature-temperature operation input 1 senses temperature for channel A and input 2 senses temperature for channel B. The alarm outputs can be configured to trigger from either input. Also, the retransmit option can be configured to retransmit either of the channel's process value or set point value.



## Input Prompts

**NOTE:**  
 Decimal points may not always be in the position specified below, depending on the the settings in the Decimal 1 **DEC 1** parameter in the Input Menu.

When you are in the Setup menus, the Series 998 displays the menu selection ( **InPt**, **0tPt**, **9LbL** or **COP7** ) in the upper display, and **SEt** in the lower display.

The Up-arrow  or Down-arrow  key selects another menu. Press the Mode key **MODE** to display the functions in the lower display and their value in the upper display. Use the Up-arrow or Down-arrow key to change the value in the upper display. The new value will not take effect until after a five-second delay or until you press the Mode key.



## Input 1

**Select the sensor type for channel A.** This selection must match the sensor type connected to terminals 8, 9 and 10. See the Appendix for more information about sensors.

- Changing the value of **In 1** changes all other prompts to the factory default values, except the Communications and Lockout menus, the **CLF** prompt in the Global Menu and the **dFL** prompt in the Calibration Menu. If you change the value, the default warning **dFLt** will flash in the upper display.



**CAUTION:**  
 Changing the value of **In 1** changes most other prompts to the factory default values and clears all program steps. Verify the correct sensor type before making a change. Document all settings before changing sensor type. Failure to follow this guideline could result in damage to equipment or property.

- Changes do not take effect automatically after five seconds; you must press the Mode key **MODE** to enter the sensor type change and advance to the next prompt.

**In 1** This prompt always appears.

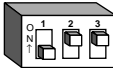
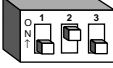
	If	Default								
	↓	↓								
<b>99</b>	<b>-1</b>	<b>-</b>								
	no DIP		J	K	T	N	E	W5	W3	Pt2
	thermocouple only		<b>J</b>	<b>H</b>	<b>t</b>	<b>n</b>	<b>E</b>	<b>C</b>	<b>d</b>	<b>Pt2</b>
			<b>In 1</b>	<b>In 1</b>	<b>In 1</b>	<b>In 1</b>	<b>In 1</b>	<b>In 1</b>	<b>In 1</b>	<b>In 1</b>
<b>99</b>	<b>-2</b>	<b>-</b>								
	Input 1 DIP		J	K	T	N	E	W5	W3	Pt2
			<b>J</b>	<b>H</b>	<b>t</b>	<b>n</b>	<b>E</b>	<b>C</b>	<b>d</b>	<b>Pt2</b>
	thermocouple		<b>In 1</b>	<b>In 1</b>	<b>In 1</b>	<b>In 1</b>	<b>In 1</b>	<b>In 1</b>	<b>In 1</b>	<b>In 1</b>
	Input 1 DIP		R	S	B					
			<b>r</b>	<b>S</b>	<b>b</b>					
	thermocouple		<b>In 1</b>	<b>In 1</b>	<b>In 1</b>					

**In 1**  
*Input 1 continued on next page.*

# Setup-Input

**ln 1**

Input 1 continued  
from previous  
page.



**dEC 1**

## Decimal 1

**Select the decimal point location for process type channel A data.**

This prompt, in conjunction with the Range Low and Range High prompts, allows you to format and limit units of measure for channel A.

- All prompts with units of measure related to channel A will display in the selected decimal format.
- This affects propbands, alarm set points, process set points, calibration offsets, deadbands and ranges.

**dEC 1** This prompt appears only if you have set Input 1 **ln 1** to a process input.



**rL1**

**rH1**

## Range Low 1 and Range High 1

Select the low and high limits for channel A. These prompts limit the adjustment range for the set points. The default values are the same as the limits of the sensor you selected by setting the input 1 DIP switch and selecting a value for Input 1 **in1**.

**NOTE:**  
These values do not affect the low or the high set point limit for process alarms.

- Process inputs are scaled by these values. Range high is the value displayed when the maximum process signal is present at the input. Range low is the value displayed when the minimum process signal is present at the input.

Example: Set **in1** to **4-20** mA.  
 Set **rL1** to **100**.  
 Set **rH1** to **500**.  
 A 4mA input will display **100**.  
 A 12mA input will display **300**.  
 A 20mA input will display **500**.

- The low and high values of each sensor type are listed on the specifications page of the Appendix.
- Choose between Fahrenheit and Celsius at the **C-F** prompt in the Global Menu.

**rL1** **rH1** These prompts always appear.

	Default	Default	Default	Default
	↓	↓	↓	↓
	<b>°F</b>	<b>°C</b>		
<b>rL1</b>	<b>32</b>	<b>1500</b>	<b>0</b>	<b>816</b>
<b>rH1</b>	<b>1500</b>	<b>1500</b>	<b>816</b>	<b>816</b>
				99 -1 - or 99 -2 -
(K)				
<b>H</b>	<b>-328</b>	<b>2500</b>	<b>-200</b>	<b>1371</b>
<b>t</b>	<b>-328</b>	<b>750</b>	<b>-200</b>	<b>399</b>
<b>n</b>	<b>32</b>	<b>2372</b>	<b>0</b>	<b>1300</b>
<b>E</b>	<b>-328</b>	<b>1470</b>	<b>-200</b>	<b>799</b>
(W5)				
<b>C</b>	<b>32</b>	<b>4200</b>	<b>0</b>	<b>2316</b>
(W3)				
<b>d</b>	<b>32</b>	<b>4200</b>	<b>0</b>	<b>2316</b>
<b>Pt2</b>	<b>32</b>	<b>2543</b>	<b>0</b>	<b>1395</b>

**rL1**  
**rH1**

Range Low 1 and Range High 1 continued on next page.

# Setup-Input

**RLI**  
**RHI**

Range Low 1 and Range High 1 continued from previous page.

**NOTE:**  
These values do not affect the low or the high set point limit for process alarms.

	Default ↓	Default ↓	Default ↓	Default ↓
	<b>OF</b>		<b>OC</b>	
	<b>RLI</b>	<b>RHI</b>	<b>RLI</b>	<b>RHI</b>
<b>r</b> <b>in1</b>	32...3200		0...1760	99__-2__-__ only
<b>s</b>	32...3200		0...1760	
<b>b</b>	32...3300		0...1816	
<b>rtd</b>	-328...1472		-200...800	
<b>rtd</b>	-999...9999		-733...5377	
<b>4-20</b>		-999...999		units
<b>0-20</b>		-999...999		units
<b>0-5</b>		-999...999		units
<b>1-5</b>		-999...999		units
<b>0-10</b>		-999...999		units

**CAL1**

## Calibration Offset 1

**Offset the channel A signal by a positive or negative value.** This allows you to compensate for lead resistance, sensor errors or other factors.

**CAL1** This prompt always appears.

If ↓		Default ↓
<b>OF</b> <b>C.F</b> (Global Menu)	&	-999 ... 0 ... 999 <b>CAL1</b> <b>CAL1</b> <b>CAL1</b>
<b>OF</b> & <b>rtd</b> <b>C.F</b> & <b>in1</b> (Global Menu) (Input Menu)		-999 ... 0.0 ... 999 <b>CAL1</b> <b>CAL1</b> <b>CAL1</b>
<b>OC</b> <b>C.F</b> (Global Menu)		-555 ... 0 ... 555 <b>CAL1</b> <b>CAL1</b> <b>CAL1</b>
<b>OC</b> & <b>rtd</b> <b>C.F</b> & <b>in1</b> (Global Menu) (Input Menu)		-555 ... 0.0 ... 555 <b>CAL1</b> <b>CAL1</b> <b>CAL1</b>
a process input is selected		-999 ... 0 ... 999 units <b>CAL1</b> <b>CAL1</b> <b>CAL1</b>

rt d 1

### RTD Calibration Curve 1

Select the calibration curve for the channel A RTD. The RTD input uses either the European (DIN, 0.003850Ω/Ω/°C) or the Japanese (JIS, 0.003916Ω/Ω/°C) linearization standard.

rt d 1 This prompt appears only if you have set in 1 to r t d or r t d.

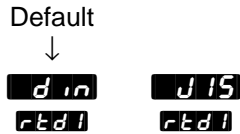

F t r 1

### Software Filter 1

Select the filter time constant, in seconds, for channel A. This smooths a rapidly changing input signal for display or control purposes.

- Select a positive value to filter only the display.
- Select a negative value to filter the input signal.
- Set the value to 0 to disable the filter.

F t r 1 This prompt always appears.

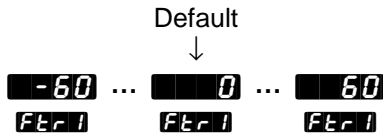

## ln2



**CAUTION:**  
Changing the value of **ln2** changes most other prompts to the factory default values. Verify the correct sensor type before making a change. Document all settings before changing the input type. Failure to follow this guideline could result in damage to equipment or property.

**NOTE:**  
If **no** is selected for **ln2** none of the other input 2 prompts will appear.

## Input 2

**Select sensor type for channel B.** This selection must match the sensor type connected to terminals 18, 19 and 20. See the Appendix for more information about sensors.

- Changing the value of **ln2** changes all other prompts to the factory default values, except the Communications and Lockout menus, the **LF** prompt in the Global Menu and the **dFL** prompt in the Calibration Menu. If you change the value, the default warning **dFLt** will flash in the upper display.
- Changes do not take effect automatically after five seconds; you must press the Mode key **MODE** to enter the sensor type change and advance to the next prompt.

**ln2** This prompt always appears.

	If ↓	Default ↓										
99	- 1 -		no DIP	J	K	T	N	E	W5	W3	Pt2	no
				<b>J</b>	<b>H</b>	<b>t</b>	<b>n</b>	<b>E</b>	<b>L</b>	<b>d</b>	<b>Pt2</b>	<b>no</b>
			thermocouple only	<b>ln2</b>	<b>ln2</b>	<b>ln2</b>	<b>ln2</b>	<b>ln2</b>	<b>ln2</b>	<b>ln2</b>	<b>ln2</b>	<b>ln2</b>
99	- 2 -		Input 2 DIP	J	K	T	N	E	W5	W3	Pt2	no
				<b>J</b>	<b>H</b>	<b>t</b>	<b>n</b>	<b>E</b>	<b>L</b>	<b>d</b>	<b>Pt2</b>	<b>no</b>
			thermocouple	<b>ln2</b>	<b>ln2</b>	<b>ln2</b>	<b>ln2</b>	<b>ln2</b>	<b>ln2</b>	<b>ln2</b>	<b>ln2</b>	<b>ln2</b>
			Input 2 DIP	R	S	B	no					
				<b>r</b>	<b>S</b>	<b>b</b>	<b>no</b>					
			thermocouple	<b>ln2</b>	<b>ln2</b>	<b>ln2</b>	<b>ln2</b>					
			Input 2 DIP	RTD	RTD(0.1°)	no						
				<b>rtd</b>	<b>rt.d</b>	<b>no</b>						
			RTD	<b>ln2</b>	<b>ln2</b>	<b>ln2</b>						
			Input 2 DIP	4-20mA	0-20mA	0-5V <sub>≠</sub>	1-5V <sub>≠</sub>	0-10V <sub>≠</sub> (dc)	no			
				<b>4-20</b>	<b>0-20</b>	<b>0-5</b>	<b>1-5</b>	<b>0-10</b>	<b>no</b>			
			process	<b>ln2</b>	<b>ln2</b>	<b>ln2</b>	<b>ln2</b>	<b>ln2</b>	<b>ln2</b>			



### Decimal 2

Select the decimal point location for channel B data. This prompt, in conjunction with the Range Low and Range High prompts, allows you to format and limit units of measure for channel B.

- All prompts with units of measure related to channel B will display in the selected decimal format.
- This affects propbands, alarm set points, process set points, calibration offsets, deadbands and ranges.

**DEC2** This prompt appears only if **ln2** is set to a process input.



### Range Low 2 and Range High 2

Select the low and high limits for channel B. These prompts limit the adjustment range for the set points. The default values are the same as the limits of the sensor you selected by setting the input 2 DIP switch and selecting a value for Input 2 **ln2**.

- Process inputs are scaled by these values. Range high is the value displayed when the maximum process signal is present at the input. Range low is the value displayed when the minimum process signal is present at the input.

Example: Set **ln2** to **4-20** mA.  
 Set **rL2** to **100**.  
 Set **rH2** to **500**.  
 A 4mA input will display **100**.  
 A 12mA input will display **300**.  
 A 20mA input will display **500**.

- The low and high values of each sensor type are listed on the specifications page of the Appendix.
- Choose between Fahrenheit and Celsius at the **C/F** prompt in the Global Menu.

**rL2** **rH2** These prompts appear only if **ln2** is not set to **no**.

**NOTE:**  
 These values do not affect the low or the high set point limit for process alarms.



Range Low 2 and Range High 2 continued on next page.

# Setup-Input

**rL2**  
**rH2**

Range Low 2 and  
Range High 2  
continued from  
previous page.

**NOTE:**  
These values do not  
affect the low or the  
high set point limit  
for process alarms.

	Default ↓	Default ↓	Default ↓	Default ↓	
	OF		OC		
	rL2	rH2	rL2	rH2	
<b>u</b>	32	1500	0	816	99 -1 - or
<b>rn2</b>	rL2	rH2	rL2	rH2	99 -2 -
(K)					
<b>H</b>	-328	2500	-200	1371	
<b>t</b>	-328	1750	-200	399	
<b>n</b>	32	2372	0	1300	
<b>E</b>	-328	1470	-200	799	
(W5)					
<b>E</b>	32	4200	0	2316	
(W3)					
<b>d</b>	32	4200	0	2316	
<b>Pt2</b>	32	2543	0	1395	
<b>r</b>	32	3200	0	1760	99 -2 - only
<b>rn2</b>					
<b>S</b>	32	3200	0	1760	
<b>b</b>	32	3300	0	1816	
<b>rtd</b>	-328	1472	-200	800	
<b>rtd</b>	-999	9999	-733	5377	
<b>4-20</b>		-999... 999			units
<b>0-20</b>		-999... 999			units
<b>0-5</b>		-999... 999			units
<b>1-5</b>		-999... 999			units
<b>0-10</b>		-999... 999			units



# CAL2

## Calibration Offset 2

Offset the channel B signal by a positive or negative value. This allows you to compensate for lead resistance, sensor errors or other factors.

**CAL2** This prompt appears only if **ln2** is not set to **no**.

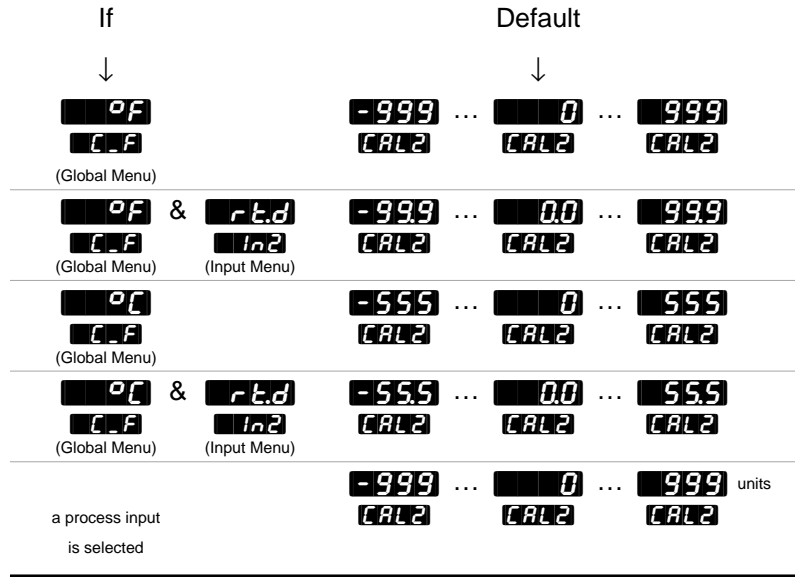

# rtd2

## RTD Calibration Curve 2

Select the calibration curve for the channel B RTD 2 input. The RTD input uses either the European (DIN, 0.003850Ω/Ω/°C) or the Japanese (JIS, 0.003916Ω/Ω/°C) linearization standard.

**rtd2** This prompt appears only if you have set **ln2** to **rtd** or **rtd**.

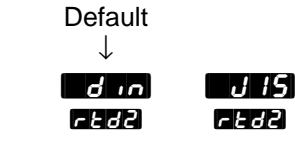

## Ftr2

### Software Filter 2

Select the filter time constant, in seconds, for channel B. This smooths a rapidly changing input signal for display or control purposes.

- Select a positive value to filter only the display.
- Select a negative value to filter the input signal.
- Set the value to **0** to disable the filter.

**Ftr2** This prompt appears only if **In2** is not set to **no**.

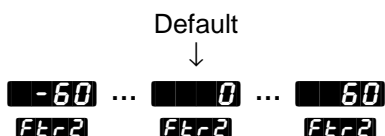

## Lin2

### Linearization 2

Set the type of relative humidity sensor being used.

- Select **30C** to provide temperature compensation when using the Vaisala HMM-30C humidity sensor.
- Select **H260** to provide temperature compensation when using the Rotronic H260 humidity sensor.
- Select **bulb** when using a wet bulb/dry bulb sensor.

**Lin2** This prompt appears only if **In2** is not set to **no**.

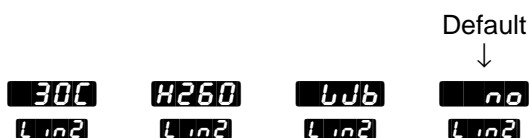

## ALT

### Altitude Compensation

Set barometric correction for altitude above sea level.



**ALT** This prompt appears only if **Lin2** is set to **bulb**.







# Setup-Output

## Reaching the Output Menu

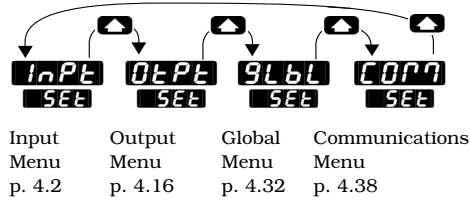

1 Begin in the Display Loop, and press the Up-arrow  and Down-arrow  keys simultaneously for three seconds to reach the Setup Menus.

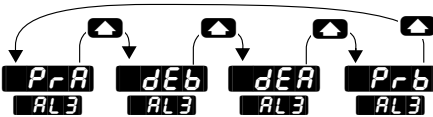

2 Press the Up-arrow key  to select one of the Setup Menus.

3 Press the Mode key  to step through the output prompts.



4 Press the Up-arrow key  or the Down-arrow key  to select one of the prompt values.

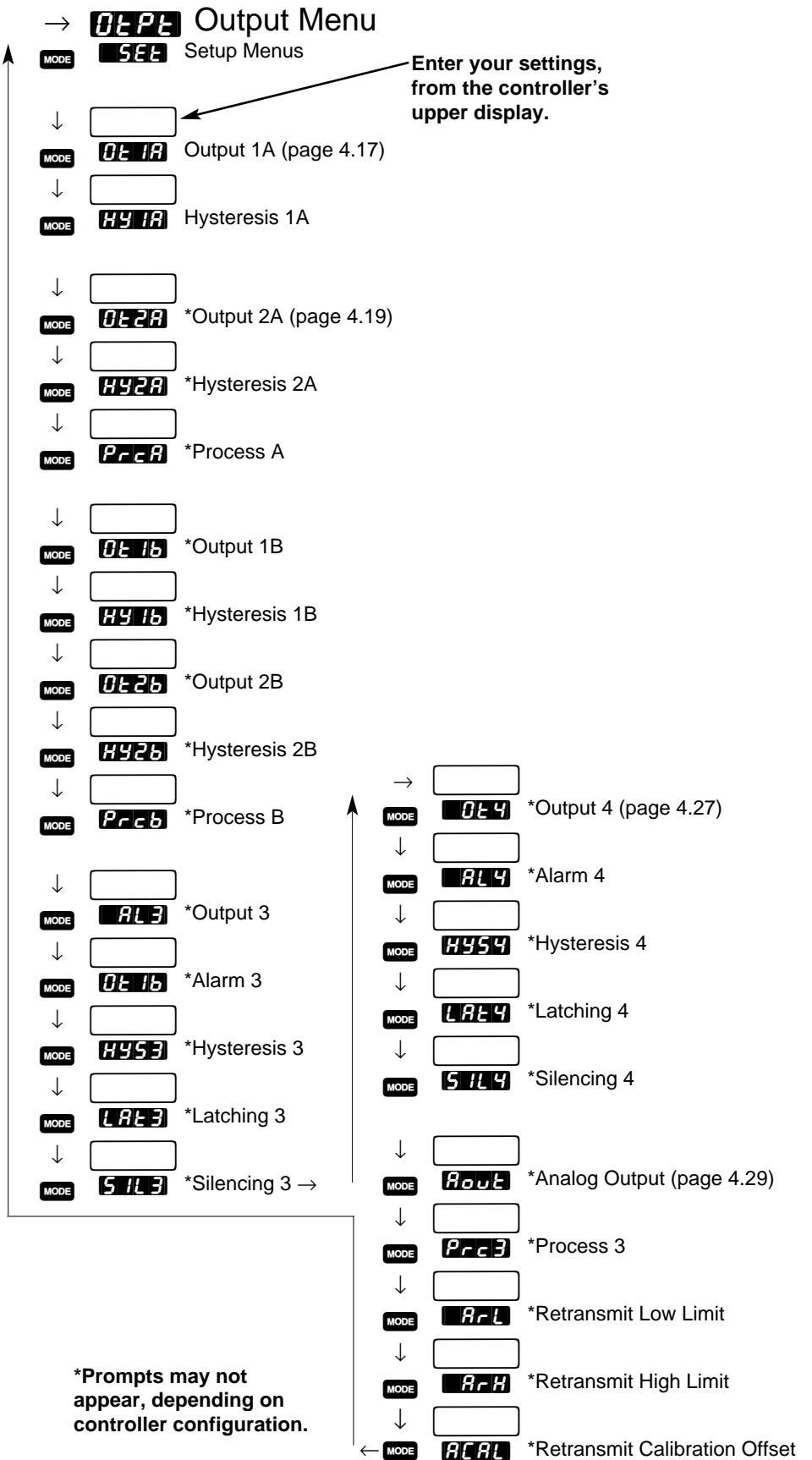



Figure 4.16 - The Output Menu.

**NOTE:**

Decimal points may not always be in the position specified below, depending on the the setting of Decimal 1 **DEC1** in the Input Menu.

## Output Prompts

When you are in the Setup menus, the Series 998 displays the menu selection ( **INPt**, **OUTPt**, **SLbL** or **COPT** ) in the upper display, and **SET** in the lower display.

The Up-arrow  or Down-arrow  key selects another menu. Press the Mode key **MODE** to display the first prompt in the lower display and its value in the upper display. Use the Up-arrow or Down-arrow key to change the value in the upper display. The new value will not take effect until after a five-second delay or until you press the Mode key.

---



## Output 1A

**Set the way that output 1A will respond to a difference between the set point and an input variable.**

- **HE** select reverse action, so that output 1A responds when the input signal is less than the set point.
- **CL** select direct action, so that output 1A responds when the input signal is more than the set point.

**0E 1A** This prompt always appears.

Default



<b>HE</b>	<b>CL</b>	<b>no</b>
<b>0E 1A</b>	<b>0E 1A</b>	<b>0E 1A</b>

---

## HY 1A

### Hysteresis 1A

Select the **switching hysteresis for output 1A**. This determines the change in temperature or process units needed to turn the output from full on to full off.

**HY 1A** This prompt does not appear if output 1 is a process output.

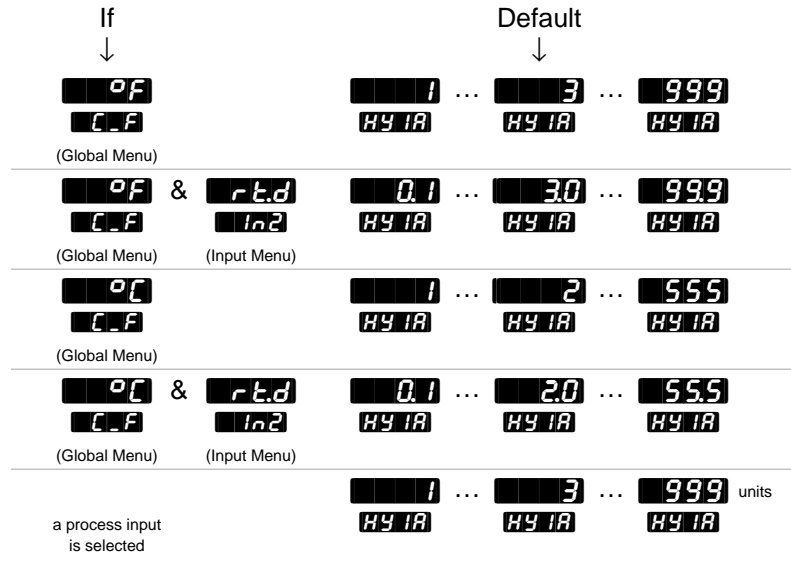

0E2A

### Output 2A

Set the way that output 2A will respond to a difference between the set point and an input variable.

- **HE** select reverse action, so that output 2A responds when the input signal is less than the set point. This prompt only appears if **0E1A** is set to **CL**.
- **CL** select direct action, so that output 2A responds when the input signal is more than the set point. This prompt only appears if **0E1A** is set to **HE**.

**0E2A** This prompt appears only if channel A output is something other than a process output (99\_\_-\_\_F\_-\_\_).

Default



<b>no</b>	<b>HE</b>	<b>CL</b>
<b>0E2A</b>	<b>0E2A</b>	<b>0E2A</b>

---

## HY2A

### Hysteresis 2A

Select the switching hysteresis for output 2A. This determines the change in temperature or process units needed to turn the output from full off to full on.

**HY2A** This prompt does not appear if output 2 is a process output.

If ↓		Default ↓	
<div style="border: 1px solid black; padding: 2px; display: inline-block;">             OF CF           </div>		<div style="border: 1px solid black; padding: 2px; display: inline-block;">             1 ... 3 ... 999 HY2A HY2A HY2A           </div>	
(Global Menu)			
<div style="border: 1px solid black; padding: 2px; display: inline-block;">             OF &amp; rtd CF In1           </div>		<div style="border: 1px solid black; padding: 2px; display: inline-block;">             0.1 ... 30 ... 999 HY2A HY2A HY2A           </div>	
(Global Menu)	(Input Menu)		
<div style="border: 1px solid black; padding: 2px; display: inline-block;">             OC CF           </div>		<div style="border: 1px solid black; padding: 2px; display: inline-block;">             1 ... 2 ... 555 HY2A HY2A HY2A           </div>	
(Global Menu)			
<div style="border: 1px solid black; padding: 2px; display: inline-block;">             OC &amp; rtd CF In1           </div>		<div style="border: 1px solid black; padding: 2px; display: inline-block;">             0.1 ... 20 ... 555 HY2A HY2A HY2A           </div>	
(Global Menu)	(Input Menu)		
		<div style="border: 1px solid black; padding: 2px; display: inline-block;">             1 ... 3 ... 999 units HY2A HY2A HY2A           </div>	

a process input is selected

### Process A

## PrCA

Select the process range for channel A.

**PrCA** This prompt appears only on controllers equipped with channel A process hardware (99\_\_-\_\_F-\_\_).

Default ↓				
4-20mA	0-20mA	0-5V $\approx$	1-5V $\approx$	0-10V $\approx$ (dc)
<div style="border: 1px solid black; padding: 2px; display: inline-block;">             4-20 PrCA           </div>	<div style="border: 1px solid black; padding: 2px; display: inline-block;">             0-20 PrCA           </div>	<div style="border: 1px solid black; padding: 2px; display: inline-block;">             0-5 PrCA           </div>	<div style="border: 1px solid black; padding: 2px; display: inline-block;">             1-5 PrCA           </div>	<div style="border: 1px solid black; padding: 2px; display: inline-block;">             0-10 PrCA           </div>



## 0E 1b

### Output 1B

Set the way that output 1B will respond to a difference between the set point and an input variable.

- **HE** select reverse action, so that output 1B responds when the input signal is less than the set point.
- **CL** select direct action, so that output 1B responds when the input signal is more than the set point.

**0E 1b** This prompt always appears.

Default



<b>HE</b>	<b>CL</b>	<b>no</b>
<b>0E 1b</b>	<b>0E 1b</b>	<b>0E 1b</b>

## HY 1b

### Hysteresis 1B

Select the switching hysteresis for output 1B. This determines the change in temperature or process units needed to turn the output from full off to full on.

**HY 1b** This prompt does not appear if output 1 is a process output.

If ↓		Default ↓	
<b>OF</b>		<b>1</b> ... <b>3</b> ... <b>999</b>	
<b>C_F</b>		<b>HY 1b</b> ... <b>HY 1b</b> ... <b>HY 1b</b>	
(Global Menu)			
<b>OF</b> & <b>rtd</b>	<b>0.1</b> ... <b>3.0</b> ... <b>999</b>		
<b>C_F</b> & <b>lnl</b>	<b>HY 1b</b> ... <b>HY 1b</b> ... <b>HY 1b</b>		
(Global Menu) (Input Menu)			
<b>OC</b>	<b>1</b> ... <b>2</b> ... <b>555</b>		
<b>C_F</b>	<b>HY 1b</b> ... <b>HY 1b</b> ... <b>HY 1b</b>		
(Global Menu)			
<b>OC</b> & <b>rtd</b>	<b>0.1</b> ... <b>2.0</b> ... <b>555</b>		
<b>C_F</b> & <b>lnl</b>	<b>HY 1b</b> ... <b>HY 1b</b> ... <b>HY 1b</b>		
(Global Menu) (Input Menu)			
a process input is selected	<b>1</b> ... <b>3</b> ... <b>999</b> units		
	<b>HY 1b</b> ... <b>HY 1b</b> ... <b>HY 1b</b>		

0t2b

## Output 2B

Set the way that output 2B will respond to a difference between the set point and an input variable.

- **HL** select reverse action, so that output 2B responds when the input signal is less than the set point.
- **CL** select direct action, so that output 2B responds when the input signal is more than the set point.

**0t2b** This prompt appears only if channel B output is something other than a process output (99\_\_-\_\_F-\_\_).



H42b

## Hysteresis 2B

Select the switching hysteresis for output 2B. This determines the change in temperature or process units needed to turn the output from full off to full on.

**H42b** This prompt does not appear if output 2 is a process output.

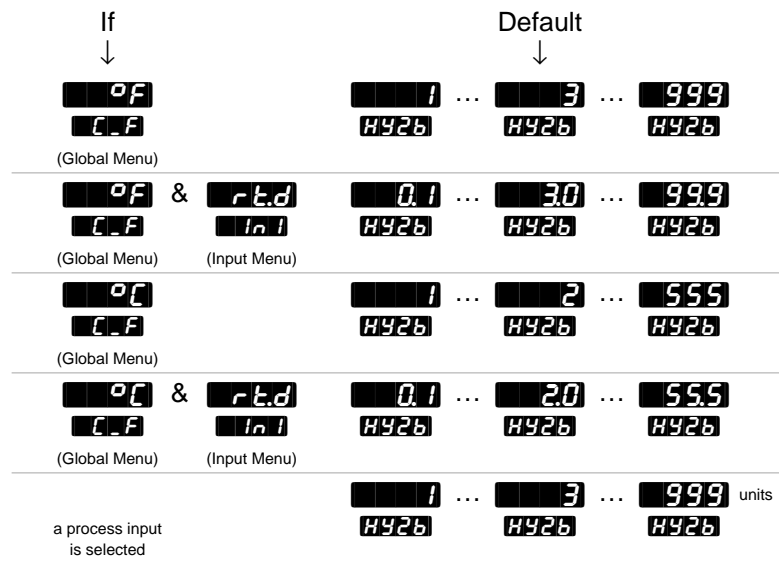

**PrCb**

## Process B

Select the process range for output B.

**PrCb** This prompt appears only on controllers equipped with output B process hardware (99\_\_-\_\_F-\_\_).

Default



4-20mA

**4-20**

**PrCb**

0-20mA

**0-20**

**PrCb**

0-5V<sub>≠</sub>

**0-5**

**PrCb**

1-5V<sub>≠</sub>

**1-5**

**PrCb**

0-10V<sub>≠</sub> (dc)

**0-10**

**PrCb**

**0t3**

## Output 3

Set the alarm type for output 3.

- **AL3** to de-energize output during alarm condition.
- **AL3n** to energize output during alarm condition.

**NOTE:**  
See Chapter 7 for more information on alarms.

**0t3** This prompt appears only on controllers equipped with output 3 hardware for a relay (99\_\_-\_\_-B\_\_, or 99\_\_-\_\_-J\_\_ or 99\_\_-\_\_-K\_\_) or switched dc (99\_\_-\_\_-C\_\_).

Default



**AL3**

**0t3**

**AL3n**

**0t3**

**no**

**0t3**

**AL3**

## Alarm 3

**Select the alarm channel and type for alarm 3.** Select the trigger points for the alarm with the **ALLO** and **ALHI** settings in the System Menu

**595.**

**NOTE:**  
See Chapter 7 for more information on alarms.

- **PrA** uses the process signal from channel A. Changing the set point does not change the alarm response.
- **dEA** uses a deviation from the channel A signal. Changing the set point changes the alarm response.

**AL3** This prompt appears only on controllers equipped with output 3 alarm hardware (99\_\_-\_\_-B\_\_, or 99\_\_-\_\_-C\_\_, or 99\_\_-\_\_-K\_\_ or 99\_\_-\_\_-J\_\_), and with **OL3** set to **AL3** or **AL3n**.

Default



<b>PrA</b>	<b>dEA</b>	<b>Prb</b>	<b>dEb</b>
<b>AL3</b>	<b>AL3</b>	<b>AL3</b>	<b>AL3</b>

---

## HYS3

### Hysteresis 3

Select the switching hysteresis for alarm 3. This determines the change in temperature or process units needed to turn the output from full off to full on.

- If the input referenced by **AL3** is set to **rtd** the range is affected as listed below.

**NOTE:**  
See Chapter 7 for more information on alarms.

**HYS3** This prompt appears only on controllers equipped with output 3 hardware (not 99\_\_-\_\_-A\_\_) and with **OLE3** (Output Menu) set to **AL3** or **AL3n**.

If ↓	Default ↓
<b>0F</b> <b>C.F</b> (Global Menu)	<b>1</b> ... <b>3</b> ... <b>999</b> <b>HYS3</b> <b>HYS3</b> <b>HYS3</b>
<b>0F</b> & <b>rtd</b> <b>C.F</b> <b>In 1</b> (Global Menu)    (Input Menu)	<b>0.1</b> ... <b>3.0</b> ... <b>999</b> <b>HYS3</b> <b>HYS3</b> <b>HYS3</b>
<b>0C</b> <b>C.F</b> (Global Menu)	<b>1</b> ... <b>2</b> ... <b>555</b> <b>HYS3</b> <b>HYS3</b> <b>HYS3</b>
<b>0C</b> & <b>rtd</b> <b>C.F</b> <b>In 1</b> (Global Menu)    (Input Menu)	<b>0.1</b> ... <b>2.0</b> ... <b>555</b> <b>HYS3</b> <b>HYS3</b> <b>HYS3</b>
a process input is selected	<b>1</b> ... <b>3</b> ... <b>999</b> units <b>HYS3</b> <b>HYS3</b> <b>HYS3</b>

# Setup-Output

**LAL3**

## Latching 3

Select whether alarm 3 will be latching or non-latching. A latching alarm **LAL** must be turned off manually. A non-latching alarm **nLA** turns off when an alarm condition no longer exists.

**NOTE:**  
See Chapter 7 for more information on alarms.

**LAL3** This prompt appears only on controllers equipped with output 3 hardware (99\_\_-\_\_-B\_\_, or 99\_\_-\_\_-C\_\_, or 99\_\_-\_\_-K\_\_ or 99\_\_-\_\_-J\_\_) and with **OL3** (Output Menu) set to **AL3** or **AL3n**.

Default



<b>nLA</b>	<b>LAL</b>
<b>LAL3</b>	<b>LAL3</b>

---

**SIL3**

## Silencing 3

Select silencing to inhibit alarm 3 on startup and to allow the operator to reset the alarm output, not the visual display.

- Silencing disables the alarm until the signal is between **ALLO** and **R3HI**.

**SIL3** This prompt appears only on controllers equipped with output 3 hardware (not 99\_\_-\_\_-A\_\_) and with **OL3** (Output Menu) set to **AL3** or **AL3n**.

Default



<b>OFF</b>	<b>On</b>
<b>SIL3</b>	<b>SIL3</b>

---

**0E4**

### Output 4

Set the alarm type for output 4.

- **AL4** de-energizes output 4 in an alarm condition.
- **AL4n** energizes output 4 in an alarm condition.

**0E4** This prompt appears only on controllers equipped with output 4 hardware for a relay (99\_\_-\_\_-\_\_-B\_\_, or 99\_\_-\_\_-\_\_-D\_\_, or 99\_\_-\_\_-\_\_-E\_\_ or 99\_\_-\_\_-\_\_-K\_\_) or switched dc (99\_\_-\_\_-\_\_-C\_\_).

Default



<b>AL4</b>	<b>AL4n</b>	<b>no</b>
<b>0E4</b>	<b>0E4</b>	<b>0E4</b>

---

**AL4**

### Alarm 4

Select the alarm channel and type for alarm 4.

**AL4** This prompt appears only on controllers equipped with output 4 hardware for a relay (99\_\_-\_\_-\_\_-B\_\_, or 99\_\_-\_\_-\_\_-D\_\_, or 99\_\_-\_\_-\_\_-E\_\_ or 99\_\_-\_\_-\_\_-K\_\_) or switched dc (99\_\_-\_\_-\_\_-C\_\_), and with **0E4** set to **AL4** or **AL4n**.

Default



<b>PrA</b>	<b>dEA</b>	<b>Prb</b>	<b>dEb</b>
<b>AL4</b>	<b>AL4</b>	<b>AL4</b>	<b>AL4</b>

---

## HYS4

### Hysteresis 4

Select the switching hysteresis for alarm 4. This determines the change in temperature or process units needed to turn the output from full off to full on.

- If the input referenced by **AL4** is set to **rt.d** the range is affected as listed below.

**HYS4** This prompt appears only on controllers equipped with output 4 hardware for a relay (99\_\_-\_\_-\_\_-B\_\_, or 99\_\_-\_\_-\_\_-D\_\_, or 99\_\_-\_\_-\_\_-E\_\_ or 99\_\_-\_\_-\_\_-K\_\_), or switched dc (99\_\_-\_\_-\_\_-C\_\_) and with **OL4** set to **AL4** or **AL4n**.

If	Default
<p>↓</p> <p><b>OF</b> <b>CLF</b> (Global Menu)</p>	<p>↓</p> <p><b>1</b> ... <b>3</b> ... <b>999</b> <b>HYS4</b>    <b>HYS4</b>    <b>HYS4</b></p>
<p><b>OF</b> &amp; <b>rt.d</b> <b>CLF</b>    <b>ln1</b> (Global Menu)    (Input Menu)</p>	<p><b>0.1</b> ... <b>3.0</b> ... <b>999</b> <b>HYS4</b>    <b>HYS4</b>    <b>HYS4</b></p>
<p><b>OC</b> <b>CLF</b> (Global Menu)</p>	<p><b>1</b> ... <b>2</b> ... <b>555</b> <b>HYS4</b>    <b>HYS4</b>    <b>HYS4</b></p>
<p><b>OC</b> &amp; <b>rt.d</b> <b>CLF</b>    <b>ln1</b> (Global Menu)    (Input Menu)</p>	<p><b>0.1</b> ... <b>2.0</b> ... <b>555</b> <b>HYS4</b>    <b>HYS4</b>    <b>HYS4</b></p>
<p>a process input is selected</p>	<p><b>1</b> ... <b>3</b> ... <b>999</b> units <b>HYS4</b>    <b>HYS4</b>    <b>HYS4</b></p>

## LAL4

### Latching 4

Select whether alarm 4 will be latching or non-latching. A latching alarm **LAL** must be turned off manually. A non-latching alarm **nLA** turns off when an alarm condition no longer exists.

**LAL4** This prompt appears only on controllers equipped with output 4 hardware for a relay (99\_\_-\_\_-\_\_-B\_\_, or 99\_\_-\_\_-\_\_-D\_\_, or 99\_\_-\_\_-\_\_-E\_\_ or 99\_\_-\_\_-\_\_-K\_\_), or switched dc (99\_\_-\_\_-\_\_-C\_\_) and with **OL4** set to **AL4** or **AL4n**.

<p>Default</p> <p>↓</p> <p><b>nLA</b>    <b>LAL</b> <b>LAL4</b>    <b>LAL4</b></p>
--



**SIL4**

**Silencing 4**

Select silencing to inhibit alarm 4 on startup and to allow the operator to reset the alarm output, not the visual display.

NOTE:  
See Chapter 7 for more information on alarms.

- Silencing disables the alarm until the signal is between **A4L0** and **A4H1**.

**SIL4** This prompt appears only on controllers equipped with output 4 hardware for a relay (99\_\_ - \_\_ - \_B\_, or 99\_\_ - \_\_ - \_D\_, or 99\_\_ - \_\_ - \_E\_ or 99\_\_ - \_\_ - \_K\_), or switched dc (99\_\_ - \_\_ - \_C\_) and with **OE4** set to **AL4** or **AL4n**.

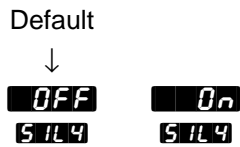

**ROUT**

**Analog Output**

Select which value to retransmit as the output 3 signal.

NOTE:  
See Chapter 8 for more information on retransmit.

- **Pr cA** retransmits the channel A input value.
- **SP A** retransmits the set point for channel A.
- **Pr cB** retransmits the channel B input value. This prompt appears only if **IN2** is not set to **no**.
- **SP b** retransmits the set point for channel B.
- **no** turns off the retransmit function.

**ROUT** This prompt appears only on controllers equipped with output 3 retransmit hardware (99\_\_ - \_\_ - M\_\_ or 99\_\_ - \_\_ - N\_\_).



# Setup-Output

**Prc3**

## Process 3

Select the range for the retransmit signal at output 3.

**Prc3** This prompt appears only on controllers equipped with output 3 retransmit hardware (99\_\_-\_\_-M\_\_ or 99\_\_-\_\_-N\_\_) and with **Rout** not set to **no**.

NOTE:  
See Chapter 8 for more information on retransmit.

Default



4-20mA

0-20mA

0-5V<sub>ac</sub>

1-5V<sub>ac</sub>

0-10V<sub>ac</sub> (dc)

**4-20**

**0-20**

**0-5**

**1-5**

**0-10**

**Prc3**

**Prc3**

**Prc3**

**Prc3**

**Prc3**

**ArL**

## Retransmit Low Limit

Select the low limit for the retransmit signal at output 3.

- The **default** value is equal to **rL1** or **rL2** (in the Input Menu) depending on whether **Rout** is set to **PrcA** or **PrcB**.

**ArL** This prompt appears only on controllers equipped with retransmit hardware (99\_\_-\_\_-M\_\_ or 99\_\_-\_\_-N\_\_) and with **Rout** not set to **no**.

**-999** ... **ArH**

**ArL**

**ArL**

**ArH**

### Retransmit High Limit

Select the high limit for the retransmit signal at output 3.

- The **default** value is equal to **rH1** or **rH2** (in the Input Menu) depending on whether **Rout** is set to **Prca** or **PrCb**.

**ArH** This prompt appears only on controllers equipped with retransmit hardware (99\_\_-\_\_-M\_\_ or 99\_\_-\_\_-N\_\_) and with **Rout** not set to **no**.



**ArCAL**

### Retransmit Calibration Offset

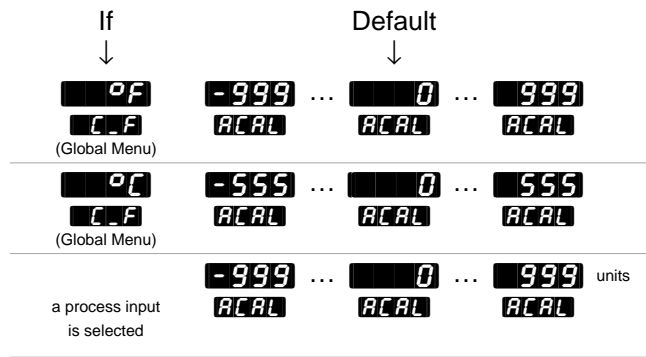

Select an offset value for the retransmit signal at output 3.

**ArCAL** This prompt appears only on controllers equipped with retransmit hardware (99\_\_-\_\_-M\_\_ or 99\_\_-\_\_-N\_\_) and with **Rout** not set to **no**.



# Setup-Global

## Reaching the Global Menu

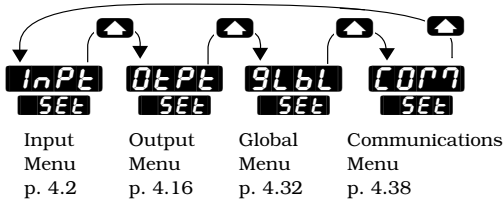

1 Begin in the Display Loop, and press the Up-arrow  and Down-arrow  keys simultaneously for three seconds to reach the Setup menus.

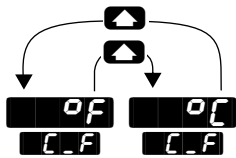

2 Press the Up-arrow key  to select one of the Setup menus.

3 Press the Mode key  to step through the prompts.



4 Press the Up-arrow key  or the Down-arrow key  to select one of the prompt values.

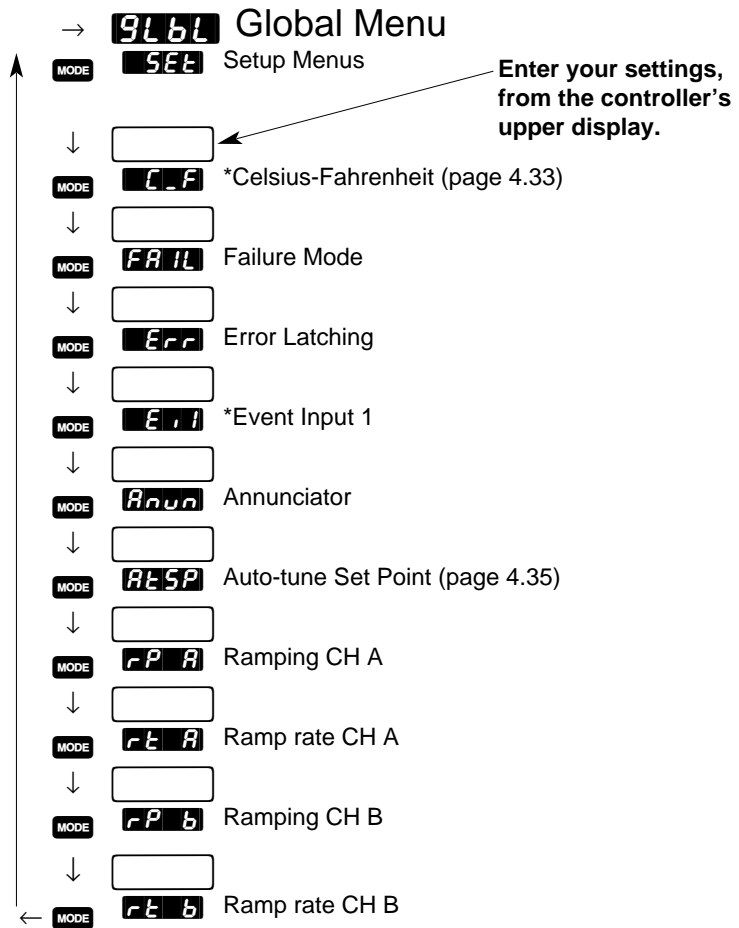



\*Prompts may not appear, depending on controller configuration.

Figure 4.32 - The Global Menu.

## Global Prompts

**NOTE:**  
 Decimal points may not always be in the position specified below, depending on the Decimal 1 **DEC 1** setting in the Input Menu.

When you are in the Setup menus, the Series 998 displays the menu selection ( **INPT**, **DEPT**, **GLBL** or **COMP** ) in the upper display, and **SET** in the lower display.

The Up-arrow  or Down-arrow key  selects another menu. Press the Mode key **MODE** to display the first prompt in the lower display and its value in the upper display. Use the Up-arrow and Down-arrow keys to change the value in the upper display. The new value will not take effect until after a five-second delay or until you press the Mode key.



### Celsius-Fahrenheit

Select which temperature scale the controller will use.

**C.F** This prompt appears only on controllers with **in1** and **in2** set to something other than a process input.

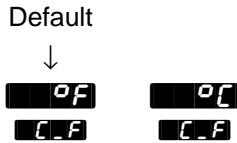

### Failure Mode

Select percent output or bumpless transfer when input fails. This prompt affects both channels.

- **bPLS** allows bumpless transfer.

**FAIL** This prompt always appears.

	If ↓	Default ↓	
Heat/Cool output	<b>bPLS</b> <b>FAIL</b>	<b>-100</b> ... <b>100</b> % <b>FAIL</b> <b>FAIL</b>	
Heat output	<b>bPLS</b> <b>FAIL</b>	<b>0</b> ... <b>100</b> % <b>FAIL</b> <b>FAIL</b>	
Cool output	<b>bPLS</b> <b>FAIL</b>	<b>-100</b> ... <b>0</b> % <b>FAIL</b> <b>FAIL</b>	

**NOTE:**  
 See Chapter 7 for more information on errors.

# Setup-Global

**Err**

## Error Latching

Select whether input errors will be latching or non-latching.

- **nLR** Non-latching errors turn off when there is no error condition.
- **LAL** Latching errors must be turned off manually.

**Err** This prompt always appears.

Default



**nLR**      **LAL**  
**Err**      **Err**

---

NOTE:  
See Chapter 7 for  
more information on  
errors .

**E.1**

## Event Input 1

Select the effect of closing the event input 1 switch.

- **no** disables event input 1.
- **LOC** locks out the front panel keys.
- **ALR** resets an alarm.
- **OFF** turns all control outputs off (de-energize relays).

**E.1** This prompt always appears.

Default



**no**      **LOC**      **ALR**      **OFF**  
**E.1**      **E.1**      **E.1**      **E.1**

---



### Annunciator

Select whether alarm messages will flash in the lower display.

**Ann** This prompt always appears.

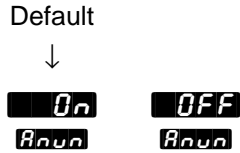

### Auto-tune Set Point

Select the percentage at which the controller will auto-tune the current control set point.

**AtSP** This prompt always appears.

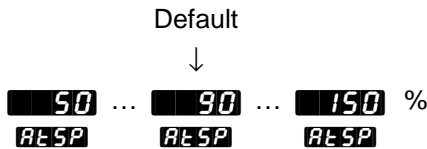

### Ramping Function for Channel A

Select when channel A will enter ramping mode.

- **StPt** Activates ramping on power up only.
- **StPt** Activates ramping on power up and any set point change.

**rP A** This prompt always appears.

NOTE:  
Lower display alternately flashes **rP** and lower display value when ramping is in process.



# Setup-Global

**rt A**

## Ramp Rate for Channel A

Set the rate of heating for channel A.

**rt A** This prompt appears when **rP A** is set to **StEt** or **StPt**.

Default  
↓  
**0** ... **100** ... **9999** degrees/minute  
**rt A**      **rt A**      **rt A**

---

**rP b**

## Ramping Function for Channel B

Select when channel B will enter ramping mode.

- **StEt** Activates ramping on power up only.
- **StPt** Activates ramping on power up and any set point change.

**rP b** This prompt always appears.

Default  
↓  
**OFF**      **StEt**      **StPt**  
**rP b**      **rP b**      **rP b**

---

NOTE:  
Lower display alternately flashes **rP** and lower display value when ramping is in process.

**rt b**

## Ramp Rate for Channel B

Set the rate of heating for channel B.

**rt b** This prompt appears when **rP b** is set to **StEt** or **StPt**.

Default  
↓  
**0** ... **100** ... **9999** degrees/minute  
**rt b**      **rt b**      **rt b**



---







# Setup-Communications

## Reaching the Communications Menu

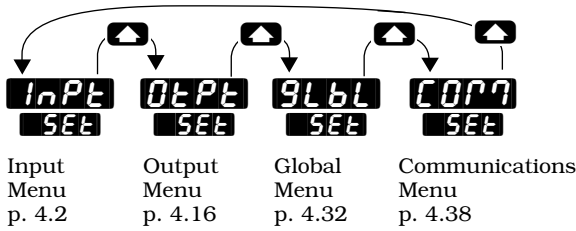
① Begin in the Display Loop, and press the Up-arrow  and Down-arrow  keys simultaneously for three seconds to reach the Setup Menu.



② Press the Up-arrow key  to select one of the Setup Menus.



③ Press the Mode key  to step through the prompts.

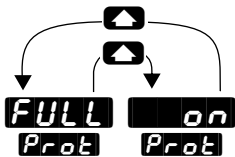



④ Press the Up-arrow key  or the Down-arrow key  to select one of the prompt values.

Figure 4.38 -  
The Communications  
Menu.



\*Prompts may not appear, depending on controller configuration.

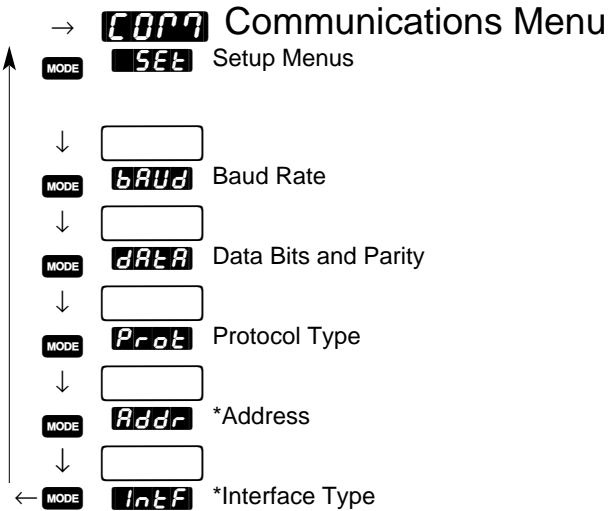

### NOTE:

The Communications Menu appears only on controllers equipped with communications hardware (99\_\_-\_\_-R\_\_ or 99\_\_-\_\_-S\_\_).

See *Data Communications with the Series 988 Family of Controllers* for detailed information on communications.

## Communications Prompts

When you are in the Setup menus, the Series 998 displays the menu selection ( **INPt**, **DEPt**, **9LbL** or **COPT** ) in the upper display, and **SEt** in the lower display.

The Up-arrow  or Down-arrow key  selects another menu. Press the Mode key **MODE** to display the first prompt in the lower display and its value in the upper display. Use the Up-arrow and Down-arrow keys to change the value in the upper display. The new value will not take effect until after a five-second delay or until you press the Mode key.

**BAUD**

### Baud Rate

Select the communications speed.

**BAUD** This prompt appears only on controllers equipped with communications hardware (99\_\_-\_\_-R\_\_ or 99\_\_-\_\_-S\_\_).

Default



<b>9600</b>	<b>300</b>	<b>600</b>	<b>1200</b>	<b>2400</b>	<b>4800</b>
<b>BAUD</b>	<b>BAUD</b>	<b>BAUD</b>	<b>BAUD</b>	<b>BAUD</b>	<b>BAUD</b>

**DATA**

### Data Bits and Parity

Select the communications format (start bit = 1, stop bit = 1).

- **7o** 7 data bits, odd parity.
- **7E** 7 data bits, even parity.
- **8n** 8 data bits, no parity.

**DATA** This prompt appears only on controllers equipped with communications hardware (99\_\_-\_\_-R\_\_ or 99\_\_-\_\_-S\_\_).

Default



<b>7o</b>	<b>7E</b>	<b>8n</b>
<b>DATA</b>	<b>DATA</b>	<b>DATA</b>

# Setup-Communications

## Prot

### Protocol Type

Select the communications protocol.

- **FULL** selects ANSI X3.28 2.2 - A.3.
- **On** selects XON/XOFF.

**Prot** This prompt appears only on controllers equipped with communications hardware (99\_\_-\_\_-R\_ or 99\_\_-\_\_-S\_).

Default



**FULL**      **On**  
**Prot**      **Prot**

---

## Addr

### Address

Select an address for the controller. The computer will use this address when communicating with this controller.

**Addr** This prompt appears only on controllers equipped with communications hardware for EIA/TIA-485 and EIA/TIA-422 (99\_\_-\_\_-S\_).

If



**485**  
**IntF**  
**422**  
**IntF**

Default



**0** ... **31**  
**Addr**      **Addr**  
**0** ... **9**  
**Addr**      **Addr**

---

## IntF

### Interface Type

Select the interface type.

- **485** selects EIA/TIA-485.
- **422** selects EIA/TIA-422.

**IntF** This prompt appears only on controllers equipped with communications hardware for EIA/TIA-485 and EIA/TIA-422 (99\_\_-\_\_-S\_).

Default



**485**      **422**  
**IntF**      **IntF**

---

# Chapter 5 The Operation Menus

## Navigating the Operation Menus

To reach the Operation Menus, begin in the Display Loop and press the Mode key **MODE**. Depending on the controller configuration, either the Set Point 2A prompt **SP2A**, the Set Point 2B prompt **SP2b** or the Operation Menu prompt **OPER** will appear in the lower display. The three Operation Menus are: System **545**; PID A **P1dA**; and PID B **P1dB**. Use the Mode key **MODE** to step past the Set Point 2A prompt **SP2A** or the Set Point 2B prompt **SP2b**, if they appear (see prompt information). Upon reaching the Operation Menu prompt **OPER** use the Up-arrow **▲** or Down-arrow **▼** key to select a menu and the Mode key **MODE** to step through a menu.

**NOTE:**  
Press the Display key **DISPLAY** to return to the Display Loop from any point in any menu.

You will not see every prompt in any of these menus. The controller's configuration and model number determine which prompts appear. After stepping through each menu, the Series 998 returns to the Operation Menu prompt. Use the Up-arrow and Down-arrow keys to select the next menu, or use the Mode key to advance through the same menu again. To move backwards through the menu hold the Mode key down and press the Up-arrow key. Use the Up-arrow or Down-arrow key to change the prompt setting.

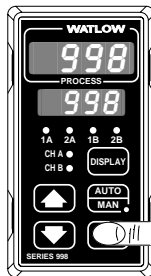

① Begin in the Display Loop, and press the Mode key to reach the Set Point 2A prompt **SP2A**, the Set Point 2B prompt **SP2b** or the Operation Menu **OPER**.

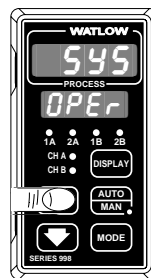
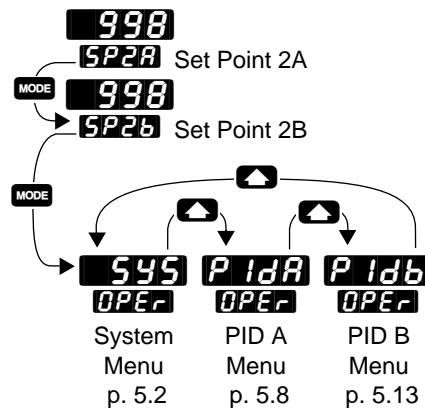

Figure 5.1 - Navigating the Operation Menus.



② Use the Mode key to step past the Set Point 2A prompt or the Set Point 2B prompt, if they appear (see prompt information). Upon reaching the Operation Menu prompt **OPER** use the Up-arrow key to select a menu.



## System Prompts

**NOTE:**  
 Decimal points may not always be in the position specified below, depending on the Decimal 1 **DEC1** and Decimal 2 **DEC2** settings in the Input Menu.

After you step past the Set Point 2A prompt **SP2A** and the Set Point 2B prompt **SP2b** to the Operation menus, the Series 998 displays the menu selection ( **SYS**, **P1dA** or **P1dB** ) in the upper display and **OPER** in the lower display.

The Up-arrow  or Down-arrow key  selects another menu. Press the Mode key **MODE** to display the first prompt in the lower display and its value in the upper display. Use the Up-arrow and Down-arrow keys to change the value in the upper display. The new value will not take effect until after a five-second delay or until you press the Mode key.

**SP2A**

### Set Point 2A

**Set the operating set point for output 2A.** Allows output 2A to operate as a boost-heat or a boost-cool output.

- The **default setting** depends on the **IN1** setting (Input Menu).

**SP2A** This prompt appears only if **OE1A** and **OE2A** (Output Menu) are both set to **HE** or to **CL**.

**RL1** ... **RH1**  
**SP2A**                      **SP2A**

**SP2b**

### Set Point 2B

**Set the operating set point for output 2B.** Allows output 2B to operate as a boost-heat or a boost-cool output.

- The **default setting** depends on the **IN2** setting (Input Menu).

**SP2b** This prompt appears only if **OE1b** and **OE2b** (Output Menu) are both set to **HE** or to **CL**.

**RL2** ... **RH2**  
**SP2b**                      **SP2b**

## Event Input 1 Status

Indicates whether the event input 1 circuit is energized, **[CLOS]**, or de-energized, **[OPEN]**. This is a read-only prompt.

**E.15** This prompt appears only if **E.11** (Global Menu) is set to something other than **no**.

<b>[OPEN]</b>	<b>[CLOS]</b>
<b>E.15</b>	<b>E.15</b>

---

## Output 3 Status

Indicates whether the output 3 circuit is energized, **[CLOS]**, or de-energized, **[OPEN]**. This is a read-only prompt.

**0E35** This prompt appears only in controllers with output 3 hardware (not 99\_\_-\_\_-A\_\_).

<b>[OPEN]</b>	<b>[CLOS]</b>
<b>0E35</b>	<b>0E35</b>

---

## Output 4 Status

Indicates whether the output 4 circuit is energized, **[CLOS]**, or de-energized, **[OPEN]**. This is a read-only prompt.

**0E45** This prompt appears only in controllers with output 4 hardware (not 99\_\_-\_\_-A\_\_).

<b>[OPEN]</b>	<b>[CLOS]</b>
<b>0E45</b>	<b>0E45</b>

---



**A3L0**

### Alarm 3 Low

Select the low trigger value for the output 3 alarm.

**A3L0** This prompt appears only if **0L3** (Output Menu) is set to **AL3** or **AL3n**.

If ↓	Default ↓
<b>PrA</b> or <b>Prb</b> <b>AL3</b> <b>AL3</b> (Output Menu)	lowest value of ... value of ... <b>A3H1</b> sensor <b>rL1</b> (or <b>rL2</b> ) <b>A3L0</b> range      (Input Menu)
<b>dEA</b> or <b>dEb</b> <b>AL3</b> <b>AL3</b> (Output Menu)	<b>-999</b> ... <b>0</b> <b>A3L0</b> <b>A3L0</b>

**A3H1**

### Alarm 3 High

Select the high trigger value for the output 3 alarm.

**A3H1** This prompt appears only if **0L3** (Output Menu) is set to **AL3** or **AL3n**.

If ↓	Default ↓
<b>PrA</b> or <b>Prb</b> <b>AL3</b> <b>AL3</b> (Output Menu)	<b>A3L0</b> ... value of ... highest <b>A3H1</b> <b>rH1</b> (or <b>rH2</b> )      value of (Input Menu)      sensor range
<b>dEA</b> or <b>dEb</b> <b>AL3</b> <b>AL3</b> (Output Menu)	<b>0</b> ... <b>999</b> ... <b>9999</b> <b>A3H1</b> <b>A3H1</b> <b>A3H1</b>

**A4L0**

## Alarm 4 Low

Select the low trigger value for the output 4 alarm.

**A4L0** This prompt appears only if **0L4** (Output Menu) is set to **AL4** or **AL4n**.

If ↓	Default ↓
<b>PrA</b> or <b>Prb</b> <b>AL4</b> <b>AL4</b> (Output Menu)	lowest value of ... sensor range
<b>dEr</b> or <b>dEb</b> <b>AL4</b> <b>AL4</b> (Output Menu)	value of (Input Menu)
	... <b>A4H1</b> <b>A4L0</b> ... <b>-999</b> ... <b>0</b> <b>A4L0</b> <b>A4L0</b>

**A4H1**

## Alarm 4 High

Select the high trigger value for the output 4 alarm.

**A4H1** This prompt appears only if **0L4** (Output Menu) is set to **AL4** or **AL4n**.

If ↓	Default ↓
<b>PrA</b> or <b>Prb</b> <b>AL4</b> <b>AL4</b> (Output Menu)	highest value of ... sensor range
<b>dEr</b> or <b>dEb</b> <b>AL4</b> <b>AL4</b> (Output Menu)	value of (Input Menu)
	... <b>A4L0</b> <b>A4H1</b> ... <b>0</b> ... <b>999</b> ... <b>9999</b> <b>A4H1</b> <b>A4H1</b> <b>A4H1</b>



## Auto-tune

**Initiate an auto-tune.**

**NOTE:**  
For more information on auto-tune see Chapter 7.

**AUT** This prompt always appears.

Default



# Operation-PID A

## Reaching the PID Menus

① Begin in the Display Loop, and press the Mode key **MODE** to reach the Set Point 2A prompt **SP2A**, the Set Point 2B prompt **SP2b** or the Operation Menu **OPER**.

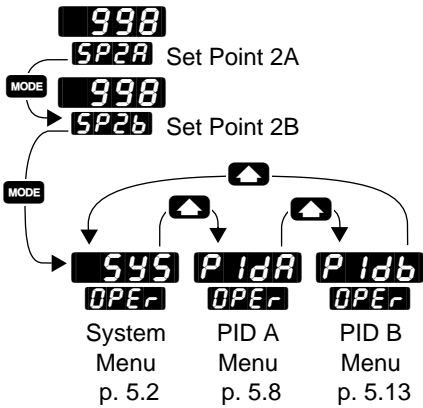

② Use the Mode key **MODE** to step past the Set Point 2A prompt **SP2A** or the Set Point 2B prompt **SP2b**, if they appear (see prompt information). Upon reaching the Operation Menu prompt **OPER** use the Up-arrow key **▲** to select a menu.

③ Press the Mode key **MODE** to step through the prompts.

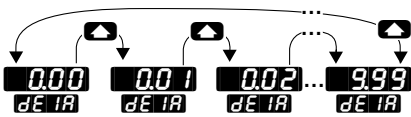

④ Press the Up-arrow key **▲** to step through the prompt values. The Down-arrow key **▼** backs through the values.

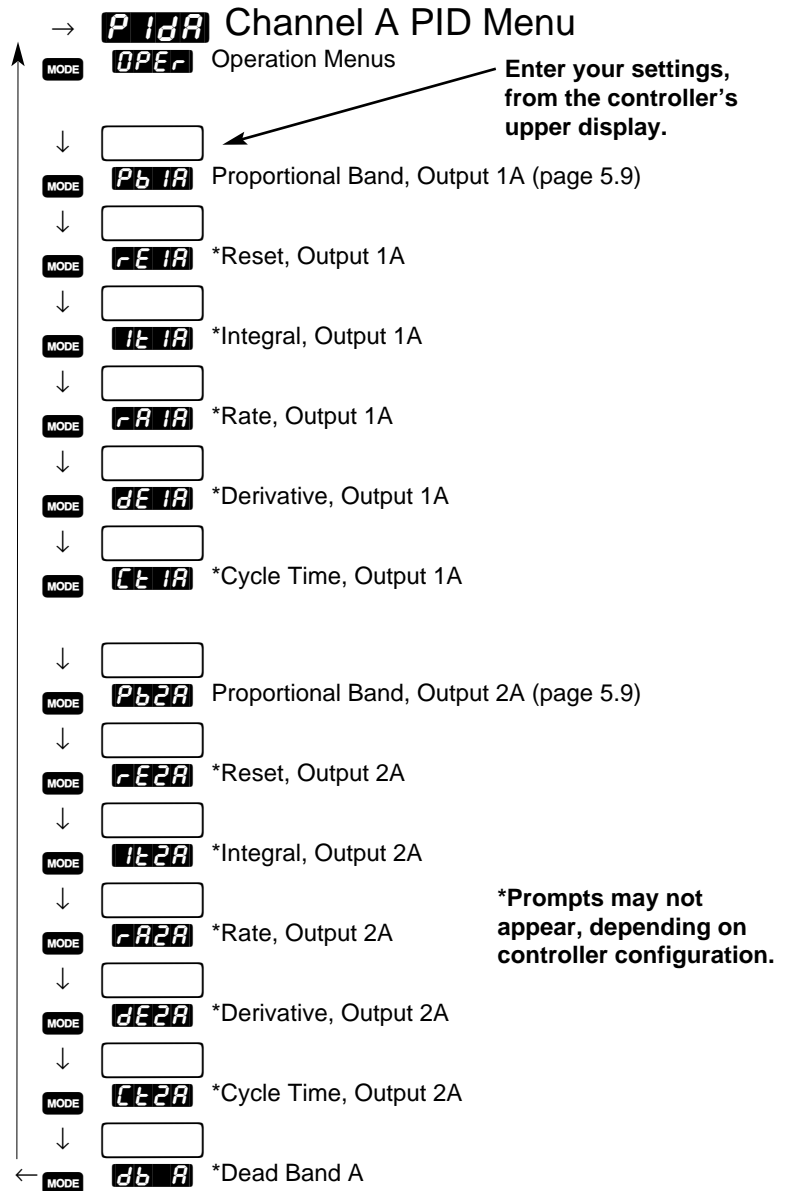

Figure 5.8 - The PID A Menu.



**NOTE:**  
 Decimal points may not always be in the position specified below, depending on the Decimal 1 **DEC1** settings in the Input Menu.

## PID A Prompts

After you step past the Set Point 2A prompt **SP2A** and the Set Point 2B prompt **SP2B** to the Operation menus, the Series 998 displays the menu selection ( **SP2A**, **P1dA** or **P1dB** ) in the upper display and **OPER** in the lower display.

The Up-arrow  or Down-arrow key  selects another menu. Press the Mode key **MODE** to display the first prompt in the lower display and its value in the upper display. Use the Up-arrow and Down-arrow keys to change the value in the upper display. The new value will not take effect until after a five-second delay or until you press the Mode key.

**Pb1A**

**Pb2A**

## Proportional Band, Output 1A or 2A

**Select the proportional band for PID channel A outputs.** If set to **0** it functions as an on/off control, and the switching differential is determined by the **HY1A** or **HY2A** value (Output Menu). The decimal precision is determined by **DEC1** (Input Menu).

**Pb1A** This prompt always appears.

	If ↓		Default ↓
(Calibration Menu)(Global Menu)	<b>US</b> <b>DFL</b>	& process <b>In1</b>	<b>0</b> ... <b>25</b> ... <b>999</b> <b>Pb1A</b> <b>Pb1A</b> <b>Pb1A</b>
(Calibration Menu)(Global Menu)	<b>US</b> <b>DFL</b>	& <b>PF</b> <b>CF</b>	<b>0</b> ... <b>25</b> ... <b>999</b> <b>Pb1A</b> <b>Pb1A</b> <b>Pb1A</b>
(Input Menu)		& <b>rt.d</b> <b>In1</b>	<b>0.0</b> ... <b>25</b> ... <b>9999</b> <b>Pb1A</b> <b>Pb1A</b> <b>Pb1A</b>
(Calibration Menu)(Global Menu)	<b>US</b> <b>DFL</b>	& <b>°C</b> <b>CF</b>	<b>0</b> ... <b>14</b> ... <b>555</b> <b>Pb1A</b> <b>Pb1A</b> <b>Pb1A</b>
(Input Menu)		& <b>rt.d</b> <b>In1</b>	<b>0.0</b> ... <b>14.0</b> ... <b>5555</b> <b>Pb1A</b> <b>Pb1A</b> <b>Pb1A</b>
(Calibration Menu)	<b>S1</b> <b>DFL</b>		<b>0.0</b> ... <b>3.0</b> ... <b>999</b> % of span <b>Pb1A</b> <b>Pb1A</b> <b>Pb1A</b>

## Operation-PID A

**rE 1A**

### Reset, Output 1A or 2A

**rE 2A**

Adjust the control action to eliminate the offset or droop between the set point and the actual process temperature for PID channel A outputs. When set to **0** reset is disabled.

**rE 1A** This prompt appears only if **dFL** (Calibration Menu) is set to **US** and **Pb 1A** is not set to **0**.

Default



**0.00** ... **99.99** repeats/min.

**rE 1A**      **rE 1A**

---

**1E 1A**

### Integral, Output 1A or 2A

**1E 2A**

Adjust the control action to eliminate the offset or droop between the set point and the actual process temperature for PID channel A outputs. When set to **0** integral is disabled.

**1E 1A** This prompt appears only if **dFL** (Calibration Menu) is set to **SI** and **Pb 1A** is not set to **0**.

Default



**0.00** ... **99.99** min./repeat

**1E 1A**      **1E 1A**

---

rA 1A

### Rate, Output 1A or 2A

rA 2A

**Adjust the rate to eliminate overshoot on startup or after the set point changes.** The rate setting will not influence the percent power if the process temperature is more than twice the proportional band from the set point. When set to **0** rate is disabled.

**rA 1A** This prompt appears only if **dFL** (Calibration Menu) is set to **US** and **Pb 1A** is set higher than **0**.

Default



**0.00** ... **9.99** min.  
**rA 1A**      **rA 1A**

---

dE 1A

### Derivative, Output 1A or 2A

dE 2A

**Adjust the derivative to eliminate overshoot on startup or after the set point changes.** The derivative setting will not influence the percent power if the process temperature is more than twice the proportional band from the set point. When set to **0** derivative is disabled.

**dE 1A** This prompt appears only if **dFL** (Calibration Menu) is set to **SI** and **Pb 1A** is set higher than **0**.

Default



**0.00** ... **9.99** min.  
**dE 1A**      **dE 1A**

---

# Operation-PID A

**CT 1A**

**CT 2A**

## Cycle Time, Output 1A or 2A

Select the time, in seconds, of a complete on/off cycle.

**CT 1A** This prompt does not appear if the output is a process output or **Pb 1A** is not set higher than **0**.

	If	Default
mechanical relay outputs	<b>5.0</b> ... <b>CT 1A</b>	<b>10.0</b> ... <b>CT 1A</b>
open collector or solid-state relay outputs	<b>br 5t</b> ... <b>CT 1A</b>	<b>10</b> ... <b>CT 1A</b>

... **999.9** min.

---

... **999.9** min.

**db A**

## Dead Band A

Select the width of the zone between the action of the channel A heating output and cooling output. If you select a positive value the heat and cool outputs cannot be energized at the same time. If you select a negative value, both outputs can be energized at the same time.

- If a process input is selected, the decimal precision will be determined by the **DEC 1** setting (Input Menu).

**db A** This prompt appears only if **Pb 1A** and **Pb 2A** are set higher than **0** and one channel A output performs heating action and the other performs cooling action.

	If	Default
(Global Menu)	<b>°F</b> ... <b>db A</b>	<b>0</b> ... <b>db A</b>
(Global Menu)	<b>°C</b> ... <b>db A</b>	<b>0</b> ... <b>db A</b>
a process input is selected	<b>-999</b> ... <b>db A</b>	<b>0</b> ... <b>db A</b>

... **999** units







# Operation-PID B

**NOTE:**

Decimal points may not always be in the position specified below depending on the the settings in the Decimal 1 **DEC 1** parameter in the Input Menu.

## PID B Prompts

After you step past the Set Point 2A prompt **SP2A** and the Set Point 2B prompt **SP2B** to the Operation menu, the Series 998 displays the menu selection ( **545**, **P.1dA** or **P.1dB** ) in the upper display and **OPER** in the lower display.

The Up-arrow  or Down-arrow key  selects another menu. Press the Mode key **MODE** to display the first prompt in the lower display and its value in the upper display. Use the Up-arrow and Down-arrow keys to change the value in the upper display. The new value will not take effect until after a five-second delay or until you press the Mode key.

**Pb 1b**

**Pb 2b**

## Proportional Band, Output 1B or 2B

**Select the proportional band for PID channel A outputs.** If set to **0** it functions as an on/off control, and the switching differential is determined by the **HY1b** or **HY2b** value (Output Menu). The decimal precision is determined by **DEC 1** (Input Menu).

**Pb 1b** This prompt always appears.

If		Default
↓		↓
<b>US</b> & <b>process</b>	<b>DFL</b> <b>ln2</b>	<b>0</b> ... <b>25</b> ... <b>999</b>
(Calibration Menu)(Global Menu)		<b>Pb 1b</b> <b>Pb 1b</b> <b>Pb 1b</b>
<b>US</b> & <b>PF</b>	<b>DFL</b> <b>C.F</b>	<b>0</b> ... <b>25</b> ... <b>999</b>
(Calibration Menu)(Global Menu)		<b>Pb 1b</b> <b>Pb 1b</b> <b>Pb 1b</b>
the above & <b>rt.d</b>	<b>ln2</b>	<b>0.0</b> ... <b>25</b> ... <b>9999</b>
(Calibration Menu) (Input Menu)		<b>Pb 1b</b> <b>Pb 1b</b> <b>Pb 1b</b>
<b>US</b> & <b>°C</b>	<b>DFL</b> <b>C.F</b>	<b>0</b> ... <b>14</b> ... <b>555</b>
(Calibration Menu)(Global Menu)		<b>Pb 1b</b> <b>Pb 1b</b> <b>Pb 1b</b>
the above & <b>rt.d</b>	<b>ln2</b>	<b>0.0</b> ... <b>14.0</b> ... <b>5555</b>
(Calibration Menu) (Input Menu)		<b>Pb 1b</b> <b>Pb 1b</b> <b>Pb 1b</b>
<b>SI</b>	<b>DFL</b>	<b>0.0</b> ... <b>3.0</b> ... <b>999</b> % of span
(Calibration Menu)		<b>Pb 1b</b> <b>Pb 1b</b> <b>Pb 1b</b>



### Reset, Output 1B or 2B



Adjust the control action to eliminate the offset or droop between the set point and the actual process temperature for PID channel B outputs. When set to **0** reset is disabled.

**rE 1b** This prompt appears only if **dFL** (Calibration Menu) is set to **US** and **Pb 1b** is not set to **0**.

Default



**0.00** ... **9999** repeats / min.

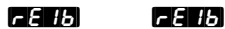

### Integral, Output 1B or 2B



Adjust the control action to eliminate the offset or droop between the set point and the actual process temperature for PID channel B outputs. When set to **0** integral is disabled.

**Ie 1b** This prompt appears only if **dFL** (Calibration Menu) is set to **SI** and **Pb 1b** is not set to **0**.

Default



**0.00** ... **9999** min. / repeat



# Operation-PID B

rA 1b

## Rate, Output 1B or 2B

rA2b

**Adjust the rate to eliminate overshoot on startup or after the set point changes.** The rate setting will not influence the percent power if the process temperature is more than twice the proportional band from the set point. When set to **0** rate is disabled.

**rA 1b** This prompt appears only if **dFL** (Calibration Menu) is set to **US** and **Pb 1b** is set higher than **0**.

Default



**0.00** ... **9.99** min.  
**rA 1b**      **rA 1b**

---

dE 1b

## Derivative, Output 1B or 2B

dE2b

**Adjust the derivative to eliminate overshoot on startup or after the set point changes.** The derivative setting will not influence the percent power if the process temperature is more than twice the proportional band from the set point. When set to **0** derivative is disabled.

**dE 1b** This prompt appears only if **dFL** (Calibration Menu) is set to **SI** and **Pb 1b** is set higher than **0**.

Default



**0.00** ... **9.99** min.  
**dE 1b**      **dE 1b**

---

**Ct 1b**

**Ct 2b**

## Cycle Time, Output 1B or 2B

Select the time, in seconds, of a complete on/off cycle.

**Ct 1A** This prompt does not appear if the output is a process output or **Pb 1A** is not set higher than **0**.

	If	Default
mechanical relay outputs	<b>5.0</b> <b>Ct 1b</b>	<b>10.0</b> ... <b>999.9</b> min. <b>Ct 1b</b>
open collector or solid-state relay outputs	<b>br 5.0</b> <b>Ct 1b</b>	<b>10</b> ... <b>999.9</b> min. <b>Ct 1b</b>

**db b**

## Dead Band B

Select the width of the zone between the action of the channel B heating output and cooling output. If you select a positive value the heat and cool outputs cannot be energized at the same time. If you select a negative value, both outputs can be energized at the same time.

- If a process input is selected the decimal precision will be determined by the **dec 2** setting (Input Menu).

**db b** This prompt appears only if **Pb 1b** and **Pb 2b** are set higher than **0** and one channel B output performs heating action and the other performs cooling action.

	If	Default
(Global Menu)	<b>0F</b> <b>C F</b>	<b>-999</b> ... <b>0</b> ... <b>999</b> <b>db b</b>
(Global Menu)	<b>0C</b> <b>C F</b>	<b>-555</b> ... <b>0</b> ... <b>555</b> <b>db b</b>
a process input is selected		<b>-999</b> ... <b>0</b> ... <b>999</b> units <b>db b</b>

# Notes

# Chapter 6 The Factory Menus

**NOTE:**  
The Factory Menu will not appear if the hardware lockout DIP is set to on. See Chapter 1 for more information.

**NOTE:**  
The Factory Menu can only be entered when the Setup prompt **SEt** is displayed.

**NOTE:**  
Press the Display key **DISP** to return to the Display Loop from any point in any menu.

## Navigating the Factory Menu

To reach the Factory menus, begin in the Display Loop and press the Up-arrow **▲** and Down-arrow **▼** keys together and hold for three seconds. The Setup prompt **SEt** will appear in the lower display. Press and hold the Up-arrow and Down-arrow keys together again for three seconds until the Factory Menu prompt **Fcty** appears in the lower display. The Factory menu will not appear if the hardware lockout DIP is set to on. (See Chapter 1 for more information on DIP switch settings.) The three Factory menus are: Panel Lockout **PLOC**; Diagnostics **dIAG**; and Calibration **CAL**. Upon reaching **Fcty** press the Up-arrow or Down-arrow key to select a menu and the Mode key **MODE** to step through a menu.

You will not see every prompt in any of these menus. The controller's configuration and model number determine which prompts appear. After stepping through each menu, the Series 998 returns to the Factory Menu prompt. Use the Up-arrow or Down-arrow key to select the next menu, or use the Mode key to advance through the same menu again. To move backwards through the menu hold the Mode key down and press the Up-arrow key. Press the Up-arrow or Down-arrow key to change the prompt setting.

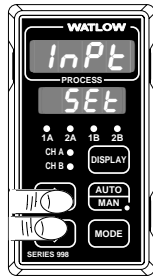

① Press **▲** and **▼** together and hold until **SEt** appears in the lower display. Press and hold again until **Fcty** appears in the lower display.

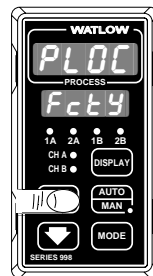
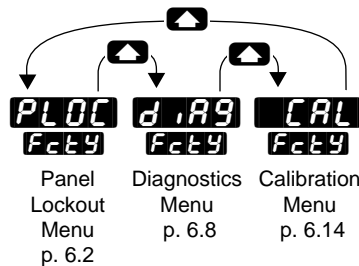

② Press **▲** to select one of the Factory menus.

Figure 6.1 - Navigating the Factory Menu.

# Factory-Panel Lockout

## Reaching the Panel Lockout Menu

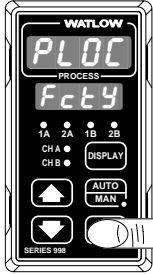

3 Select the Panel Lockout Menu **PLOC**, then press **MODE** to step through the prompts.

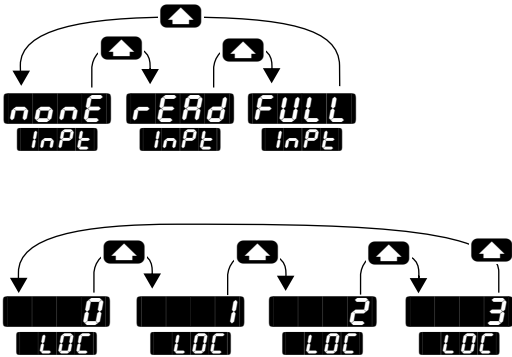

4 Press **▲** or **▼** to select one of the prompt values.

Figure 6.2 - The Panel Lockout Menu.

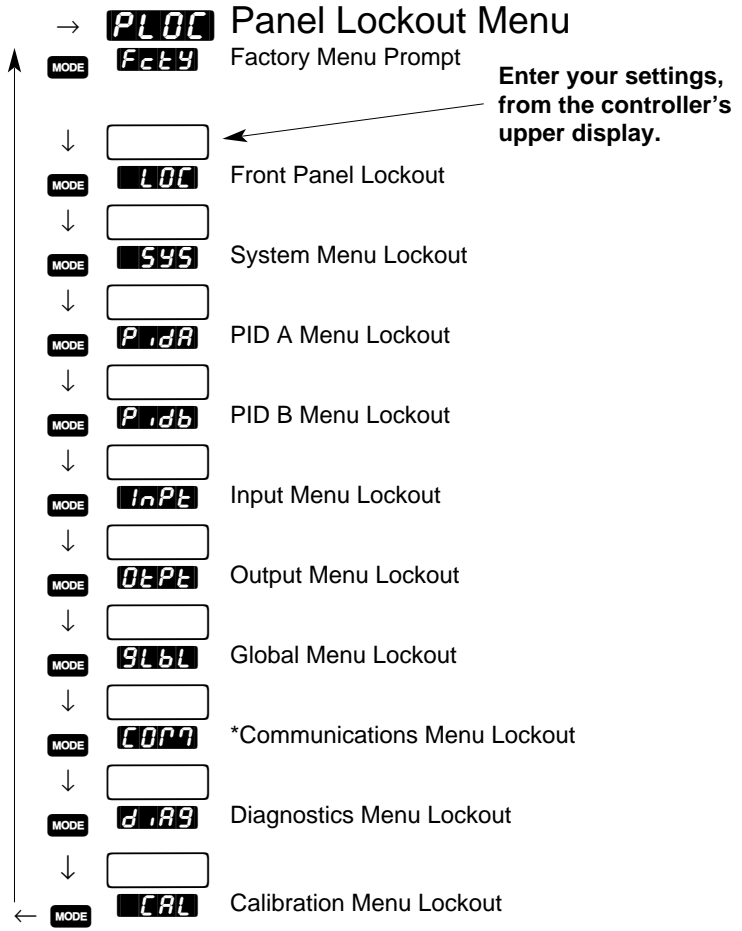



Enter your settings, from the controller's upper display.

\*Prompt may not appear, depending on controller configuration.



## Panel Lockout Prompts

When you are in the Factory menus, the Series 998 displays the menu selection ( **PLoc**, **diAG** or **CAL** ) in the upper display and **FcLd** in the lower display.

The Up-arrow  or Down-arrow key  selects another menu. Press the Mode key **MODE** to display the first prompt in the lower display and its value in the upper display. Use the Up-arrow and Down-arrow keys to change the value in the upper display. The new value will not take effect until after a five-second delay or until you press the Mode key.

The prompts within the Panel Lockout Menu allow you to lockout an entire menu. You can set the level of lockout to none **none**, read only **rEAd** or lockout read and write **FULL**.



**CAUTION:**  
Setting **LOC** to **2** or **3** disables the Auto/Man key **AUTO MAN** and will force the controller into manual mode if an open sensor occurs. Verify that the controller is operating in the desired mode (auto or manual) before setting the lockout level. Failure to do so could result in damage to equipment and/or property.

## Front Panel Lockout

**Set the lockout level for the front panel.** This allows you to disable keys on the front of the controller.

- **0** enables all keys.
- **1** disables the Mode key **MODE**.
- **2** disables the Mode key **MODE** and the Auto/Man key **AUTO MAN**.
- **3** disables the Mode key **MODE**, the Auto/Man key **AUTO MAN**, the Display key **DISPLAY** and locks the set point value.

**LOC** This prompt always appears.

Default



# Factory-Panel Lockout



## System Menu Lockout

Select the lockout level for the System Menu. Set the lockout to no lockout **none**, read only **read** or full lockout **FULL**.

**LOC** This prompt always appears.

Default



## PID A Menu Lockout

Select the lockout level for the PID A Menu. Set the lockout to no lockout **none**, read only **read** or full lockout **FULL**.

**P\_idA** This prompt always appears.

Default



## PID B Menu Lockout

Select the lockout level for the PID B Menu. Set the lockout to no lockout **none**, read only **read** or full lockout **FULL**.

**P\_idB** This prompt always appears.

Default



## InPt

### Input Menu Lockout

Select the lockout level for the **Input Menu**. Set the lockout to no lockout **nonE**, read only **rERd** or full lockout **FULL**.

**InPt** This prompt always appears.



## OutPt

### Output Menu Lockout

Select the lockout level for the **Output Menu**. Set the lockout to no lockout **nonE**, read only **rERd** or full lockout **FULL**.

**OutPt** This prompt always appears.



## GLbL

### Global Menu Lockout

Select the lockout level for the **Global Menu**. Set the lockout to no lockout **nonE**, read only **rERd** or full lockout **FULL**.

**GLbL** This prompt always appears.



# Factory-Panel Lockout

**COP**

## Communications Menu Lockout

Select the lockout level for the **Communications Menu**. Set the lockout to no lockout **none**, read only **read** or full lockout **FULL**.

**COP** This prompt appears only if the controller is equipped with communications hardware (99\_- \_\_- \_R\_ or 99\_- \_\_- \_S\_).

Default



<b>none</b>	<b>read</b>	<b>FULL</b>
<b>COP</b>	<b>COP</b>	<b>COP</b>

---

**d .A9**

## Diagnostics Menu Lockout

Select the lockout level for the **Diagnostics Menu**. Set the lockout to no lockout **none**, read only **read** or full lockout **FULL**.

**d .A9** This prompt always appears.

Default



<b>none</b>	<b>read</b>	<b>FULL</b>
<b>d .A9</b>	<b>d .A9</b>	<b>d .A9</b>

---

**CAL**

## Calibration Menu

Select the lockout level for the **Calibration Menu**. Set the lockout to no lockout **none**, read only **read** or full lockout **FULL**.

**CAL** This prompt always appears.

Default





<b>none</b>	<b>read</b>	<b>FULL</b>
<b>CAL</b>	<b>CAL</b>	<b>CAL</b>

---



# Factory-Diagnostics

## Reaching the Diagnostics Menu

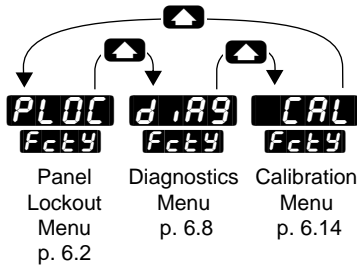

1 Press the Up-arrow  and Down-arrow  keys together and hold until the **SEE** prompt appears in the lower display. Press and hold again until the **Fcty** prompt appears in the lower display.

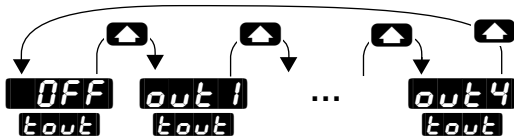

2 Use the Up-arrow  key to step from the Panel Lockout Menu **PLOC** to the Diagnostics Menu **d.i.a.g.**.

3 Press the Mode key  to step through the prompts.



4 Press the Up-arrow key  or the Down-arrow key  to select one of the prompt values.

**NOTE:**  
In the Diagnostics Menu only the values of **d.i.s.p** and **kout** can be changed.

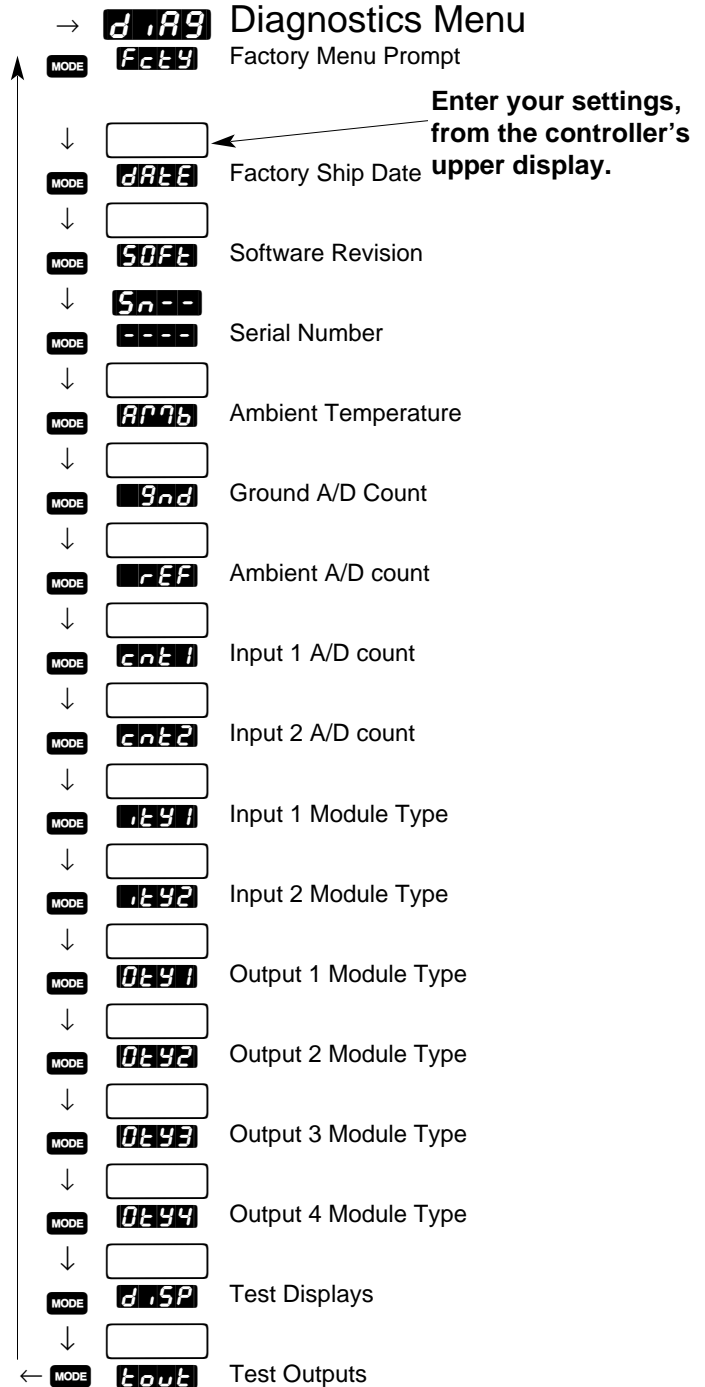

Figure 6.8 - The Diagnostics Menu.

**DATE**

## Factory Ship Date

**Shows the date that the final factory control test was performed.** The first two digits represent the week as numbered from **01--** to **52--**. The second two digits represent the year **--94**, **--95**, etc...

**DATE** This prompt always appears.

---

**SOFT**

## Software Revision

**Shows the controller's software revision code.** This letter should match the software revision code on the cover of the manual that came with your controller; **---n** and W998-XUMN Rev N02.

**SOFT** This prompt always appears.

---

**Sn--**

## Serial Number

**Shows the controller's serial number.** The first two letters in the upper display are to indicate that the controller is in serial number mode. The right half of the upper display shows the first two digits of the serial number. The lower display shows the last four digits of the serial number.

**Sn34**

**5678**

This is what the controller with the serial number 0998345678 would display.

**Sn--** This prompt always appears.

---

**AP76**

## Ambient Temperature

**Shows the ambient temperature at the input 1 terminals.** The temperature is shown in °F in the form **0000** regardless of the settings of **DEC1**, **DEC2**, **DFL** or **C.F**.

**AP76** This prompt always appears.

---

# Factory-Diagnostics

**Acnt**

**9nd**

**cnt 1**

**cnt 2**

## Factory Use Only

**These prompts are used only at the factory.**

**Acnt 9nd cnt 1 cnt 2** These prompts always appear.

---

**.tY 1**

**.tY 2**

## Inputs 1 and 2 Module Types

**Display which input module is installed in the controller.** Please document this value before contacting the factory for technical assistance.

Input Types

- **none** no input module
- **tc** thermocouple only module
- **UOFF** universal off
- **UrtD** universal rtd
- **Utch** universal high-gain thermocouple
- **UtlL** universal low-gain thermocouple
- **UPVU** universal millivolts
- **UPrc** universal process

**.tY 1 .tY 2** These prompts always appear.

---



**0EY1**

**0EY2**

**0EY3**

**0EY4**

## Outputs 1, 2, 3 and 4 Module Types

**Display the controller's output module.** Please document this value before contacting the factory for technical assistance.

Output Types

- **none** no output module (A)
- **SSr1** 0.5A solid-state relay (K)
- **SS1S** 0.5A solid-state relay with suppression (B)
- **dc** switched dc open collector (C)
- **rLYc** form C relay (E)
- **rLcS** form C relay with suppression (D)
- **rLAb** relay A/B (J)
- **Proc** process output (F)
- **UrEt** voltage/retransmit (N)
- **IrEt** current/retransmit (M)
- **SPLY** power supply (T)
- **232** EIA/TIA-232 communications (R)
- **485** EIA/TIA-485 or EIA/TIA-422 communications (S)



**0EY1 0EY2 0EY3 0EY4** These prompts always appear.

---

# Factory-Diagnostics

**d,SP**

## Test Displays

**Runs a brief test of the controller's displays and LEDs.** To run the test, scroll through the Diagnostics Menu until **d,SP** is shown in the lower display. Use the Up-arrow key  or Down-arrow key  to select **YES** from the upper display and press the mode key **MODE**.

The controller will run pattern tests, blink all the LEDs on and off, and end with the model number in both displays.



**d,SP** This prompt always appears.

Default  
↓  
**no**      **YES**  
**d,SP**    **d,SP**

---

**tout**

## Test Outputs

**This prompt tests each output.** To run the test, scroll through the Diagnostics Menu until **tout** is shown in the lower display. Use the Up-arrow key  or Down-arrow key  to select an output **out1**, **out2**, **out3**, or **out4**. The LED for that output should light after a second or two indicating that the output has been successfully energized. Do not press the mode key **MODE** to activate the test; it starts automatically when anything other than **OFF** is selected.

If any of the LEDs fail to light contact the factory.

**tout** This prompt always appears.

Default  
↓  
**OFF**    **out1**    **out2**    **out3**    **out4**  
**tout**    **tout**    **tout**    **tout**    **tout**

---



# Factory-Calibration

## Reaching the Calibration Menu

1 Enter the Factory Menu again by pressing the Up-arrow and Down-arrow keys simultaneously for three seconds to enter the Setup Menu **SEE**, and an additional three seconds to enter the Factory Menu **Fcty**.

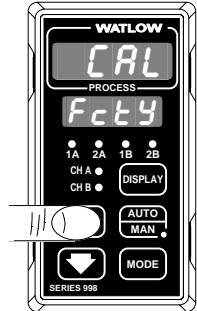

2 At the **Fcty** prompt, press or to advance to the **CAL** prompt.

3 Press **MODE** to advance through the Calibration Menu.

The Calibration Menu **CAL** begins with input 1 prompts and continues through to output 3 prompts. Located at the end of the Calibration Menu are the Restore Factory Values and Default Parameters prompts. See below.

**Before continuing through the Calibration Menu, refer to the proper calibration procedure for your controller.**

**NOTE:**  
This menu will continue looping through the parameters until you press the Display key **DISPLAY** to return to the Display loop.

Figure 6.14 - The Calibration Menu

Refer to *Calibrating Watlow Process Controls* for information about the Calibration Menu.

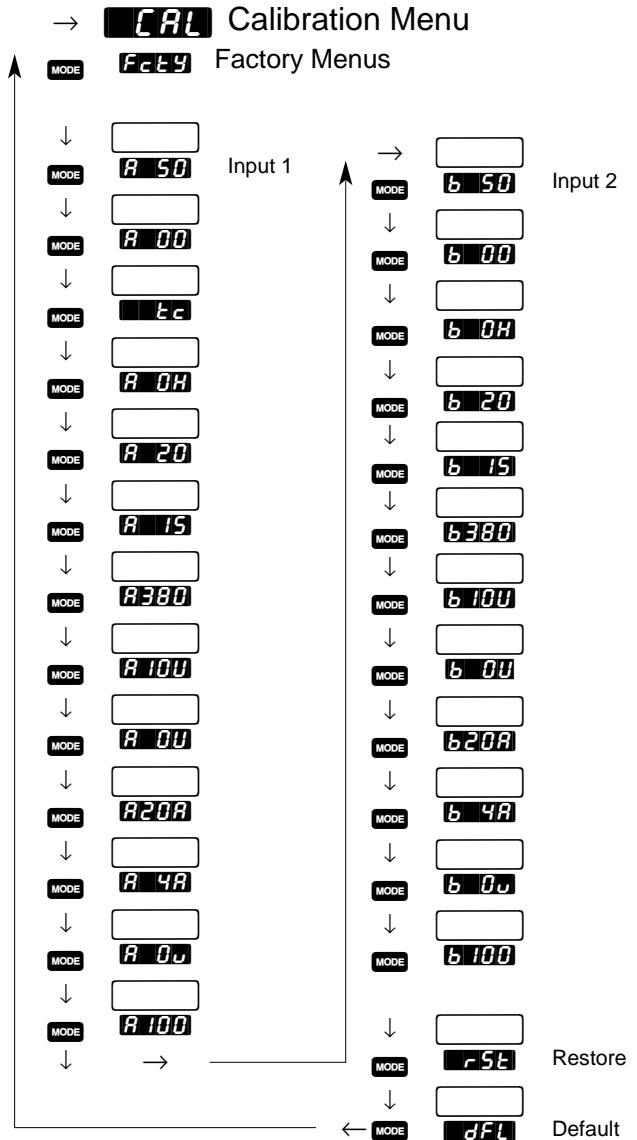





A digital display showing the prompt "rSt" in a monospace font.

## Restore

**Restores the original factory calibration values.** This is a simple way to recover if you make a mistake calibrating the controller.

 This prompt always appears.



Default  
↓  
   
 

---





A digital display showing the prompt "dFL" in a monospace font.

## Default

**Set the operating parameter defaults to U.S. or international measures.**

-  (U.S.) sets the controller to °F; rate in minutes; proportional band in degrees or units; and reset in repeats per minute.
-  (international) sets the controller to °C; derivative in minutes; proportional band in percent of span; and integral in minutes per repeat.

 This prompt always appears.

Default  
↓  
   
 

---

# Notes

# Chapter 7 Tuning, Manual Operation, Alarms and Error Codes

## Auto-tuning (Heat and/or Cool)

The Series 998 can automatically tune the PID parameters for both channel A and channel B to fit the characteristics of your particular system. Only one channel's PID set can be auto-tuned at a time.

Before beginning the auto-tune sequence, make sure the **RLSP** parameter located in the Global Menu is at the proper setting. This allows the user to select the tuning set point as a percentage of the current control set point. See Chapter 4 for more information on this parameter. The figure below uses the 90% default setting to define the auto-tuning process.

Once the auto-tune sequence has begun, the control outputs proportional band for the associated channel is set to 0 and that channel goes into an on/off mode of control at the channel's set point percentage determined by the **RLSP** parameter. The channel's displayed set point remains unchanged. Note: Any change in the set point while in auto-tune restarts the auto-tune procedure.

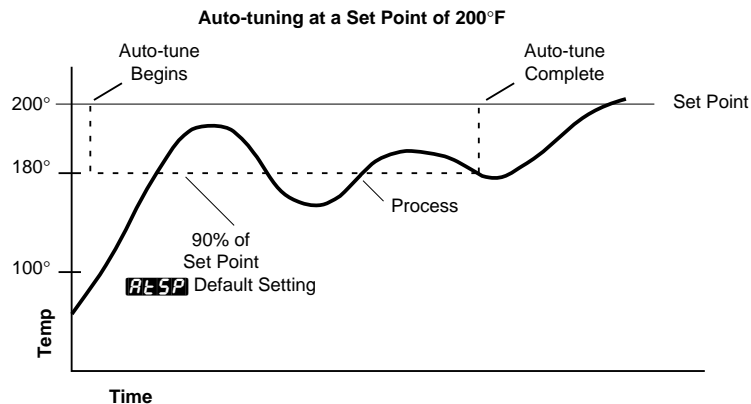

Figure 7.1 - Auto-tuning Example.

Once the control finishes “learning” the system, it returns the channel to standard PID control with the PID values automatically set as a result of auto-tuning.

Once auto-tune has begun, the process must cross the set point four times within 80 minutes for the 998 to successfully complete the auto-tune. If this does not happen within the time limit, the Series 998 chooses PID values based on the 80-minute tuning cycle performed.

## Tuning

To start auto-tuning:

1. Press the Mode key **MODE** until the **AUT** prompt appears in the lower display.
2. Use the Up-arrow or Down-arrow key **▲** **▼** to select **PidA** or **PidB** depending on which channel you want to tune. Only one PID set can be auto-tuned at a time.
3. Press the Mode key. While the control is in the tuning mode, the lower display alternately displays the normal information and the **tune** prompt. The time between alternations is one second.
4. When tuning is complete, the display return to their previous state and **AUT** reverts to **OFF**. The 998 installs appropriate PID tuning parameters and saves them in non-volatile memory.

To abort auto-tuning either reset the **AUT** prompt to **OFF** or cycle power off and on. In all cases, aborting auto-tune restores all values to those previous to auto-tuning.



### CAUTION:

If a mechanical relay or contactor is switching power to the load, a longer cycle time may be desirable to minimize wear on the mechanical components. Typical life of a mechanical relay is 100,000 cycles.

### NOTE:

Tune heating outputs at a set point above the ambient process value.

Tune cooling outputs at a set point below the ambient process value.

## Manual Tuning

For optimum control performance, tune both channels of the Series 998 to your thermal system. The tuning settings here are for a broad spectrum of applications; your system may have somewhat different requirements. NOTE: This is a slow procedure, taking from minutes to hours to obtain optimum values.

If you are not familiar with tuning a thermal system, we suggest you obtain and become familiar with the reference below before attempting to tune your system.

### *Tuning of Industrial Control Systems*

by Armando B. Corripio

Published by the Instrument Society of America (ISA)

Member \$48.00, list \$60.00 (approx). phone: (919) 549-8411

Perform this procedure on both channels PID sets, they are functionally identical. The parameters within the procedure apply to both output 1A, 2A, 1b and 2b and PID A and PID B.

1. **Apply power to the Series 998** and enter a set point. Begin with these PID parameters:

**Pb** set to **1**;

**rE** or **It** set to **0.00**;

**rA** or **dE** set to **0.00**;

**CE** set to **50**;

**CAL** set to **0**;

**AUT** set to **OFF**.

2. **Proportional Band Adjustment:** Gradually increase **Pb** until the upper display process value stabilizes at a constant value. The process value will not be right on set point because the initial reset value is 0.00 repeats per minute. (If **Pb** is set to **0**, then **rE** or **It**



and **■ rA** or **■ dE** are inoperative, and the 998 functions as a simple on/off control.) The **■ HY** (hysteresis) prompt determines the switching differential value.

- 3. Reset/Integral Adjustment:** Gradually increase **■ rE** or decrease **■ iE** until the upper display process value begins to oscillate or “hunt.” Then slowly decrease **■ rE** or increase **■ iE** until the upper display stabilizes again near set point.
- 4. Cycle Time Adjustment:** Set **■ cE** as required. Faster cycle times sometimes achieve the best system control. See Chapter 8, “Burst Firing” for more information. However, if a mechanical contactor or solenoid is switching power to the load, a longer cycle time may be desirable to minimize wear on the mechanical components. Experiment until the cycle time is consistent with the quality of control you want. **■ cE** will not appear on units with a process output (option “F”).
- 5. Rate/Derivative Adjustment:** Increase **■ rA** or **■ dE** to 1.00 minute. Then raise set point by 20° to 30°F, or 11° to 17°C. Observe the system’s approach to the set point. If the load process value overshoots the set point, increase **■ rA** or **■ dE** to 2.00 minutes.  
 Raise the set point by 20° to 30°F, or 11° to 17°C and watch the approach to the new set point. If you increase **■ rA** or **■ dE** too much, approach to the set point is very sluggish. Repeat as necessary until the system rises to the new set point without overshooting or approaching the set point too slowly.
- 6. Calibration Offset Adjustment:** You may want your system to control to a process value other than the value coming from the input sensor. If so, measure the difference between that process value (perhaps at another point in the system) and the process value showing in the upper display. Then enter the **■ CAL** offset value you want. Calibration Offset adds or subtracts degrees from the value of the input signal.

## Manual and Automatic Operation

To change from auto to manual, first select the desired channel using the Display key. Press the Display **DISPLAY** key until the desired CH A or CH B indicator light is lit. Only one should be lit. Then press the Auto/Manual key **AUTO**/**MAN** twice. Note: Both channels can operate in the manual modes simultaneously.

Manual operation provides open-loop control of the outputs from a range of -100% to 100% output for heat/cool operation, 0% to 100% for heat only and -100% to 0% for cool only. The 998 allows a negative output value only if **0E1A**, **0E2A**, **0E1B** or **0E2B** is set to cool. Automatic operation provides closed loop on/off or PID control. When the operator transfers from a closed loop to an open loop, the 998 sets the power level to the setting of the **FRIL** parameter. If it is set to **bPLS** (bumpless transfer) then it retains the power level of the closed-loop control. When the 998 returns to closed loop control, it restores the previous set point process value.

The Auto/Manual light (located at the key) indicates auto or manual operation. When it is on, the channel indicated by the CH A or CH B light, is

in manual operation. Note: It cannot be determined which channel is in the manual mode when both CH A and CH B lights are on. When the Auto/Manual light is off, the channel is in automatic operation. When the Auto/Manual key is pressed once the Auto/Manual light will flash. Press the key again within five seconds to complete the change in operation.

When a sensor fails, the channel associated with the failed sensor switches from automatic to manual operation.

- If **FAIL** is set to **BPLS**, and the bumpless transfer conditions are met, process has stabilized at a power level less than 75% ( $\pm 5\%$ ) for a two minute period prior to sensor failure, the channel switches to manual operation at the last automatic power level. If the conditions are not met, the output goes to 0% power (outputs disabled).
- If **FAIL** parameter is set to a specific value (-100% to 100%), the channel switches to manual at the power selected by the **FAIL** parameter.

When transferring a channel from auto to manual operation, the control output(s) remains stable (“bumpless”). When transferring from automatic to manual operation, the output value appears in the lower display. In the automatic operation the set point appears in the lower display.

Figure 7.4 - Alarms Jumper Location.

## Changing the Output 3 Alarm Jumper

If you have model number 99\_ \_ \_ \_ \_ J \_ \_ \_ , output 3 can be configured as a Form A (NO and common contact) or Form B (NC and common contact) alarm. To change the alarm jumper:

1. Remove the control from the case.  
Release the two tabs on one side of the control, then release the two tabs on the opposite side. You may need to rock the bezel back and forth several times to release the chassis.
2. Set the jumper to the position you want.  
See below for jumper location.
3. Return the control chassis to the case. Be sure you have it oriented correctly. Press firmly, but gently, to seat the chassis.

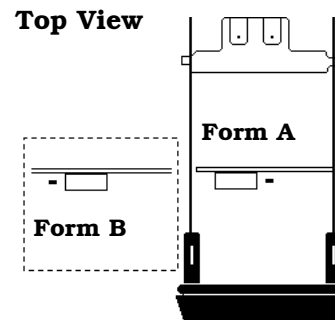

**When you select Form A, the contact is open when power is removed from the control. When selecting Form B, the contact is closed when power is removed.**

## Using Alarms

Output 3 and/or 4 of the Series 998 can be selected as alarms. This is accomplished in the Output Menu under the **0E3** or **0E4** prompt. If **AL3** or **AL4** is selected, the output is energized in the non-alarm condition and de-energizes the output in the alarm condition. Selecting **AL3n** or **AL4n** reverses this action; the output is then de-energized in the non-alarm condition and energized in an alarm condition.

A flashing lower display indicates an alarm state. Note: If the **Rnun** parameter in the Global Menu is set to **OFF** the lower display will not flash and there will be no indication of an alarm state on the front panel.

Once you've configured the outputs as alarms, enter the Output Menu again and select the **AL3** and/or **AL4** prompt respectively. These prompts select the type of alarm, process or deviation. Each may be independently set low and high. Choose between process input 1 **PrA**, process input 2 **Prb**, deviation input 1 **dEA** or deviation input 2 **dEb**.

**Example:** **PrA** can reference the channel A (input 1) process value against the **A3LO** and **A3HI** settings, or **Prb** can reference the input 2 process value against the **A3LO** and **A3HI** settings.

A **process alarm** sets an absolute temperature. When the process exceeds that absolute temperature limit an alarm occurs. A process alarm is independent from set point.

**Example:** If your set point is 100°F and a process alarm is set at 150°F as the high alarm, and 50°F as the low limit, the high limit trips at 150°F, and the low alarm at 50°F. If you change the set point, the process alarm limits remain the same.

A **deviation alarm** alerts the operator when the process strays too far from set point. The operator can enter independent high and low alarm settings. The reference for the deviation alarm is the set point. Any change in set point causes a corresponding shift in the deviation alarm. Low alarms are usually set at a negative deviation while high alarms are a positive deviation.

**Example:** If your set point is 100°F and a deviation alarm is set at +7°F as the high limit, and -5°F as the low limit, the high alarm trips at 107°F, and the low alarm at 95°F. If you change the set point to 130°F, the alarms follow the set point and trips at 137°F and 125°F.

Alarms can be latching or non-latching. When the alarm condition is removed, a non-latching alarm automatically clears the alarm output and alarm message, if one is present. You must manually clear a latching alarm before it will disappear.

There may be an alarm message flashing in the lower display, but if the **Rnun** prompt is set to **OFF** (located in the Global Menu), no alarm message is displayed. When an alarm message is displayed, it alternately flashes with the current prompt at a 1 second interval in the lower display.

To clear a latching alarm, first correct the condition then press the Auto/Man key **AUTO** **MAN** once.

**Alarm silencing** is available with all alarms. This function overrides the alarm on initial power up. On power up, the alarm message is masked and the output reflects a non-alarm condition. The silencing is active until the process has entered the safe region located between the low and high alarm settings. Any future deviation outside this safe region triggers an alarm. If an alarm occurs at this point, the output can be silenced by pressing the Auto/Man key once, but the alarm message is still displayed.

**NOTE:**  
An alarm display will be masked by an error condition or when the control is in the Calibration or Setup menus.

## Error Code E1 and E2 Messages

Four dashes, **----**, in the upper display indicate a Series 998 error. The associated channel goes to 0% output. To view the error code press the Auto/Man key once. The upper display shows the error code for five seconds before returning to the **----** display.

### **E1 1** or **E2 1**: A/D underflow error

The input 1 or 2 A/D circuit is underrange. An open or reversed polarity sensor is the most likely cause. Check the sensor; if the connection is good, and functions properly, call the factory. Make sure input settings, in the Input Menu, match your sensor.

### **E1 2** or **E2 2**: Sensor underrange error

The input 1 or 2 sensor generated a value lower than that allowed for the range of the sensor, or the A/D circuitry malfunctioned. Enter a valid input. The A/D value is below the range limits, but within the A/D conversion limits. Make sure input settings, in the Input Menu, match your sensor.

### **E1 3** or **E2 3**: Sensor overrange error

The input 1 or 2 sensor generated a value higher than that allowed for the range of the sensor, or the A/D circuitry malfunctioned. Enter a valid input. The A/D value is above the range limits, but within the A/D conversion limits. Make sure input settings, in the Input Menu, match your sensor.

### **E1 4** or **E2 4**: A/D overflow error

The input 1 or 2 A/D circuit is overrange. An open or reversed polarity sensor is the most likely cause. Check the sensor; if the connection is good, and functions properly, call the factory. The A/D input voltage is too high to convert an A/D signal. Make sure input settings, in the Input Menu, match your sensor.

### **E-3**: Ambient temperature error

The ambient temperature of the Series 998 has dropped below 32°F/0°C or risen above 149°F/65°C. A calibration error can also cause the error code. Try a calibration restore to clear this alarm.

### **E-4**: RAM verification error

An internal RAM failure has occurred. Contact the factory.

### **E-5**: Non-volatile checksum error

Displayed when an EEPROM checksum error has been detected. Turn the power off then back on again. If the error has not cleared, contact the factory.

### **E-9**: Configuration error

An incorrect module was installed in the control. Contact the factory.

**NOTE:**  
An alarm display will be masked by an error condition or when the control is in the Calibration or Setup menus.

## Error Code Actions

**Error codes `Er3`, `Er4`, `Er5` or `Er9` will result in these conditions**

- The control is in Auto operation with both control outputs off.
- The alarm outputs are in their alarm state (de-energized with the indicator light on).
- The lower display is blank.
- The upper display indicates the error code.
- All keys are inactive.
- `Er5` resets all Setup Menu prompts to their default values.
- The above conditions occur regardless of the value of `FAIL` or the presence of the Setup or Factory menus

Cycle power to the control. If the error is still present contact the factory.

Percent Output Level with <code>FAIL</code> not set to <code>bPLS</code>		
	Heat	Cool
<code>FAIL</code> set 1% to 100%	<code>FAIL</code> setting	0%
<code>FAIL</code> set -100% to -1%	0%	<code>FAIL</code> setting

**Error codes other than `Er3`, `Er4`, `Er5` or `Er9` will result in these conditions:**

- If `FAIL` is set to `bPLS` (Global Menu)...

...and the control was in auto operation when the error occurred, it goes into manual (% power) operation. If the output power is less than 75% ( $\pm 5\%$ ) power, and there was a change in power ( $< 5\%$ ) within the last two minutes, the 998 switches into manual operation at the last automatic power level (bumpless transfer). If the control was in manual operation, it remains there. (Press the Auto/Man key `AUTO/MAN` once to see the error code.) The error code is shown in the upper display for five seconds and the lower display shows the % power. After five seconds the upper display reverts to the `----` display.



If the control was operating with stable output values when the error occurred, it continues to operate at those levels on a % power basis. If output values were not stable, or the percent output was greater than 75%, the control outputs go to 0% power (off).

- If `FAIL` is not set to `bPLS` (Global Menu)...

...and the control was in auto operation when the error occurred, it goes into manual (% power) operation. The power level is determined by the `FAIL` value (-100 to 100%). See the table.

# Error Codes

## To clear an error code:

- If **Err** is set to **nLA**, the error code should clear once the problem is corrected.
- If **Err** is set to **LAt**, correct the problem and cycle power. You can also clear the error by pressing the Up-arrow or Down-arrow keys   to enter the Setup Menu, then press the Display key **DISPLAY**.

# Chapter 8 Applications

This chapter details many of the 998 features unique to Watlow controls. **Some of this material is advanced and requires previous background or experience.**

What we will cover in this chapter:

Standard Features

- Burst fired, zero cross output
- Dead Band
- Retransmit
- Transmitter Power Supply

## Burst Fired Zero Cross Output

The Series 998 can provide a variable time base, zero cross output with superior controllability compared to a fixed time base, time proportioning control. This eliminates the need for additional hardware associated with power control devices. When either output 1A or 1B is ordered as a switched dc (option C) or a solid-state relay (option K) the 998 can operate as a burst fired control via the cycle time prompt(s).

Here's an example.

The Series 998 is used to control a heated platen in a semiconductor oven. In the past, a control with a 4-20mA output was required to be used with a power control having burst fire control circuitry. This resulted in additional system cost. Now the power control is replaced with a Watlow QPAC with a QCD card, or a Watlow dc input SSR. This accepts a signal directly from an open collector output on the 998, providing smoother control at a lower overall system cost.

To achieve this, set **CL 1A** (PID A Menu) to **brst**. This sets the output 1, PID set A cycle time to burst fire.

  
**CAUTION:**  
Burst fired operation requires ac power supplied to the Series 998. Failure to supply ac power to the control results in no zero cross references, and causes the Series 998 to default to a cycle time of one second.

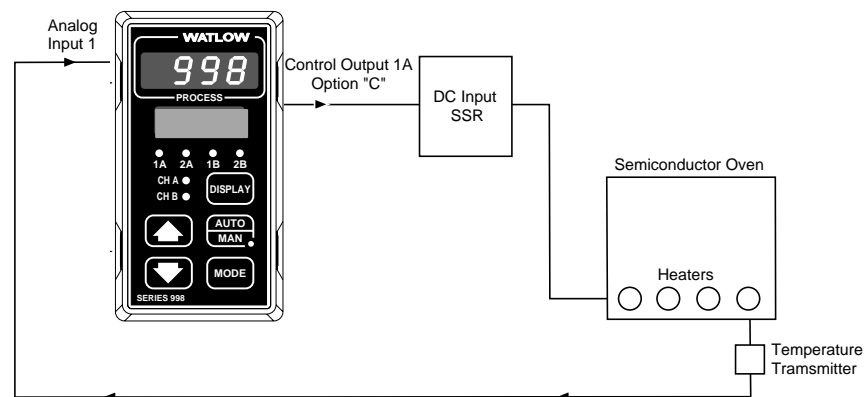

Figure 8.1-  
Burst Fire Example.

# Retransmit

## Retransmit

When output 3 is ordered as a process retransmit output, channel A set point or process value (input 1) or channel B set point or process value (input 2) can be configured for retransmit. For accurate readings when retransmitting to a chart recorder, the retransmit can be scaled and offset separate from the input settings.

When model number 99 \_ \_ - \_ \_ \_ -M \_ \_ \_ is ordered, a process range of 0-20mA or 4-20mA can be selected at the **Prc3** prompt in the Output Menu.

When model number 99 \_ \_ - \_ \_ \_ -N \_ \_ \_ is ordered, a process range of 0-5V<sub>ac</sub>, 1-5V<sub>ac</sub> or 0-10V<sub>ac</sub> (dc) can be selected.

Here's an example:

The Series 998 is controlling the temperature of a heat treat oven. The temperature of the process must be recorded on a chart recorder. The oven's temperature operating range is from 600 to 900°F. The chart recorder requires a 4-20mA signal.

To achieve this, set the following prompts in the Output Menu.

Set **Rout** to **PrcA** to identify the channel A process as the retransmit variable.

Set **Prc3** to **420** to select 4-20mA as the output signal.

Set **A-L** to **600** to set the retransmit signal low range at 600°F.

Set **A-H** to **900** to set the retransmit signal high range at 900°F.

Setting **ACAL** to **0** assumes no calibration offset is required.

The retransmit output will be 4mA until the oven temperature reaches 600°F. Once it is above 600°F, the retransmit signal increases proportionally to the temperature rise until it reaches 900°F. The retransmit signal will not exceed 4mA or 20mA.

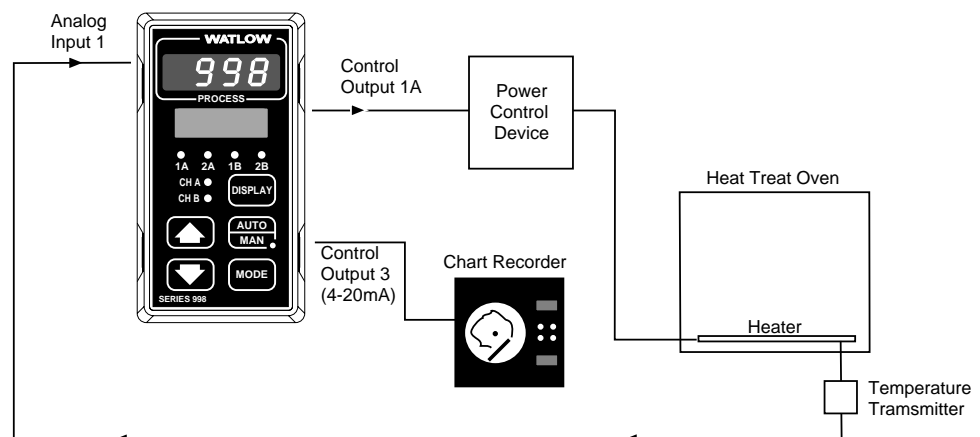

Figure 8.2 - Retransmit Example.



## Dead Band

The dead band prompts, **db A** and **db B**, determine the amount of interaction between heat (reverse acting) and cool (direct acting) control outputs for channel A and B respectively. Dead band directly offsets the cool control output set point. With a positive dead band, both control outputs will never be on at the same time. With the process in the dead band, while it is a positive dead band, the output value is determined by adding the output value from each control output and applying the result to the appropriate output. If the dead band value is negative the heat and cool outputs can be on at the same time.

## Transmitter Power Supply

When option "T" is ordered for output 3 or 4, the Series 998 can supply power to external signal conditioners, transducers or transmitters. Via internal DIP switches, user selectable options include 5, 12 or 20V<sup>±</sup> (dc) @ 30mA ratings, which are UL listed.

# Notes



## Warranty

---

The Watlow Series 998 is warranted to be free of defects in material and workmanship for 36 months after delivery to the first purchaser for use, providing that the units have not been misapplied. Since Watlow has no control over their use, and sometimes misuse, we cannot guarantee against failure. Watlow's obligations hereunder, at Watlow's option, are limited to replacement, repair or refund of purchase price, and parts which upon examination prove to be defective within the warranty period specified. This warranty does not apply to damage resulting from transportation, alteration, misuse, or abuse.

## Watlow Controls

---

Watlow Controls is a division of Watlow Electric Manufacturing Company, St. Louis, Missouri, a manufacturer of industrial electric heating products, since 1922. Watlow begins with a full set of specifications and completes an industrial product that is manufactured totally in-house, in the U.S.A. Watlow products include electric heaters, sensors, controls and switching devices. The Winona operation has been designing solid state electronic control devices since 1962, and has earned the reputation as an excellent supplier to original equipment manufacturers. These OEMs depend upon Watlow Controls to provide compatibly engineered controls which they can incorporate into their products with confidence. Watlow Controls resides in a 100,000 square foot marketing, engineering and manufacturing facility in Winona, Minnesota.

## Returns

---

1. Call Watlow Customer Service, (507) 454-5300, for a Return Material Authorization (RMA) number before returning any item for repair. We need this information:
  - Ship to address
  - Contact name
  - Ship via
  - Symptoms and/or special instructions
  - Name and phone number of person returning the material.
  - Bill to address
  - Phone number
  - Your P.O. number
2. Prior approval and an RMA number, from the Customer Service Department, is needed when returning any unused product for credit. Make sure the RMA number is on the outside of the carton, and on all paperwork returned. Ship on a Freight Prepaid basis.
3. After we receive your return, we will examine it and determine the cause for your action.
4. In cases of manufacturing defect, we will enter a repair order, replacement order, or issue credit for material. A 20-percent restocking charge is applied for all returned stock controls and accessories.
5. If the unit is unrepairable, it will be returned to you with a letter of explanation. Repair costs will not exceed 50 percent of the original cost.

## Shipping Claims

---

When you receive your Watlow control, examine the package for any signs of external damage it may have sustained enroute. If there is apparent damage either outside the box or to its contents, make a claim with the shipper immediately. Save the original shipping carton and packing material.

## Glossary, A-J

**annunciator** — A visual display that uses pilot lights to indicate the former or existing condition of several items in a system.

**burst fire** — A power control method that repeatedly turns on and off full ac cycles. Also called zero-cross fire, it switches close to the zero-voltage point of the ac sine wave. Variable-time-base burst fire selectively holds or transits ac cycles to achieve the desired power level. See zero cross.

**calibration offset** — An adjustment to eliminate the difference between the indicated value and the actual process value.

**closed loop** — A control system that uses a sensor to measure a process variable and makes decisions based on that feedback.

**cold junction** — see junction, cold.

**cold junction compensation** — Electronic means to compensate for the effective temperature at the cold junction.

**default parameters** — The programmed instructions that are permanently stored in the microprocessor software.

**derivative** — The rate of change in a process variable. Also known as rate. See PID.

**derivative control (D)** — The last term in the PID control algorithm. Action that anticipates the rate of change of the process, and compensates to minimize overshoot and undershoot. Derivative control is an instantaneous change of the control output in the same direction as the proportional error. This is caused by a change in the process variable (PV) that decreases over the time of the derivative (TD). The TD is in units of seconds.

**Deutsche Industrial Norm (DIN)** — A set of technical, scientific and dimensional standards developed in Germany. Many DIN standards have worldwide recognition.

**DIN** — See Deutsche Industrial Norm.

**droop** — In proportional controllers, the difference between set point and actual value after the system stabilizes.

**duty cycle** — The percentage of a cycle time in which the output is on.

**external transmitter power supply** — A dc voltage source that powers external devices.

**filter, digital (DF)** — A filter that slows the response of a system when inputs change unrealistically or too fast. Equivalent to a standard resistor-capacitor (RC) filter.

**form A** — A single-pole, single-throw relay that uses only the normally open (NO) and common contacts. These contacts close when the relay coil is energized. They open when power is removed from the coil.

**form B** — A single-pole, single-throw relay that uses only the normally closed (NC) and common contacts. These contacts open when the relay coil is energized. They close when power is removed from the coil.

**form C** — A single-pole, double-throw relay that uses the normally open (NO), normally closed (NC) and common contacts. The operator can choose to wire for a form A or form B contact.

**hysteresis** — A change in the process variable required to re-energize the control or alarm output. Sometimes called switching differential.

**integral** — Control action that automatically eliminates offset, or droop, between set point and actual process temperature. See auto-reset.

**integral control (I)** — A form of temperature control. The I of PID. See integral.

**isolation** — Electrical separation of sensor from high voltage circuitry. Allows use of grounded or ungrounded sensing element.

**JIS** — See Joint Industrial Standards.

**junction, cold** — Connection point between thermocouple metals and the electronic instrument. See junction, reference.

**junction, reference** — The junction in a ther-

mocouple circuit held at a stable, known temperature (cold junction). Standard reference temperature is 32°F (0°C).

**NEMA 4X** — A NEMA specification for determining resistance to moisture infiltration. This rating certifies the controller as washable and corrosion resistant.

**on/off controller** — A temperature controller that operates in either full on or full off modes.

**open loop** — A control system with no sensory feedback.

**output** — Control signal action in response to the difference between set point and process variable.

**overshoot** — The amount by which a process variable exceeds the set point before it stabilizes.

**P control** — Proportioning control.

**PD control** — Proportioning control with derivative (rate) action.

**PDR control** — Proportional derivative control with manual reset, used in fast responding systems where the reset causes instabilities. With PDR control, an operator can enter a manual reset value that eliminates droop in the system.

**PI control** — Proportioning control with integral (auto-reset) action.

**PID** — Proportional, integral, derivative. A control mode with three functions: proportional action dampens the system response, integral corrects for droop, and derivative prevents overshoot and undershoot.

**proportional** — Output effort proportional to the error from set point. For example, if the proportional band is 20° and the process is 10° below set point, the heat proportioned effort is 50 percent. The lower the PB value, the higher the gain.

**proportional band (PB)** — A range in which the proportioning function of the control is active. Expressed in units, degrees or percent of span. See PID.

**proportional control** — A control using only the P (proportional) value of PID control.

**range** — The area between two limits in which a quantity or value is measured. It is usually described in terms of lower and upper limits.

**rate** — Anticipatory action that is based on the rate of temperature change, and compensates to minimize overshoot and undershoot. See derivative.

**rate band** — A range in which the rate function of a controller is active. Expressed in multiples of the proportional band. See PID.

**reference junction** — see junction, reference.

**remote** — A controller that receives its set point signal from another device called the master.

**remote set point** — A signal that indicates the set point for the process, and is sent from another device.

**reset** — Control action that automatically eliminates offset, or droop, between set point and actual process temperature. Also see integral.

**automatic reset** — The integral function of a PI or PID temperature controller that adjusts the process temperature to the set point after the system stabilizes. The inverse of integral.

**automatic power reset** — A feature in latching limit controls that does not recognize power outage as a limit condition. When power is restored, the output is re-energized automatically, as long as the temperature is within limits.

**manual reset** — 1) A feature on a limit control that requires human intervention to return the limit to normal operation after a limit condition has occurred. 2) The adjustment of a proportional control to raise the proportional band to compensate for droop.

**resistance temperature detector (RTD)** — A sensor that uses the resistance temperature characteristic to measure temperature. There are two basic types of RTDs: the wire RTD, which is usually made of platinum, and the thermistor, which is made of a semiconductor material. The wire RTD is a positive temperature coefficient sensor only, while the thermistor can have either a negative or positive temperature coefficient.

## Glossary, R-Z

**RTD** — See resistance temperature detector.

**thermal system** — A regulated environment that consists of a heat source, heat transfer medium or load, sensing device and a control instrument.

**thermocouple (t/c)** — A temperature sensing device made by joining two dissimilar metals. This junction produces an electrical voltage in proportion to the difference in temperature between the hot junction (sensing junction) and the lead wire connection to the instrument (cold junction).

**thermocouple break protection** — The ability of a control to detect a break in the thermocouple circuit and take a predetermined action.

**three-mode control** — Proportioning control with integral (reset) and derivative (rate). Also see PID.

**time proportioning control** — A method of controlling power by varying the on/off duty cycle of an output. This variance is proportional to the difference between the set point and the actual process temperature.

**transmitter** — A device that transmits temperature data from either a thermocouple or a resistance temperature detector (RTD) by way of a two-wire loop. The loop has an external power supply. The transmitter acts as a variable resistor with respect to its input signal. Transmitters are desirable when long lead or extension wires produce unacceptable signal degradation.

**zero cross** — Action that provides output switching only at or near the zero-voltage crossing points of the ac sine wave. See burst fire.

**zero switching** — See zero cross.

% out LED 3.1

0-20MA or 4-20MA process 2.8,  
2.9, 2.10, 2.11

0-5V $\bar{=}$ , 1-5V $\bar{=}$ , 0-10V $\bar{=}$  (dc) process  
2.8, 2.9, 2.10, 2.11

1A, 2A, 1B, 2B indicator lights 3.1

## A

ac outputs 2.10, 2.11, 2.12, 2.13

address of controller 4.40

alarm 3 4.24

alarm 3 high 5.5

alarm 3 low 5.5

alarm 4 4.27

alarm 4 high 5.6

alarm 4 low 5.6

alarm jumper 7.4 - 7.5

alarms 7.4 - 7.5

alarm silencing 7.5

altitude compensation 4.14

ambient temperature 6.9

analog output 4.29

annunciator 4.35

auto/man key 3.1

auto/manual operation 7.3

automatic operation 7.3 - 7.4

auto-tune 5.7

auto-tune set point 4.35

auto-tuning 7.1

## B

baud rate 4.39

burst fired, zero cross output 8.1

## C

calibration menu 6.6, 6.14 - 6.15

calibration offset 1 4.8

calibration offset 2 4.13

calibration offset adjustment 7.3

celsius-fahrenheit 4.33

channel A indicator light 3.1

channel A input wiring 2.8

Channel A PID Menu 5.8

channel A process and set point 3.2

channel A output wiring 2.10

channel B input wiring 2.9

Channel B PID Menu 5.13

channel B process and set point 3.2

channel B output wiring 2.11

channel B indicator light 3.1

clearing error codes 7.8

Communications Menu 4.38 - 4.40

communications menu lockout 6.6

cycle time adjustment 7.3

cycle time, output 1A or 2A 5.12

cycle time, output 1B or 2B 5.17

## D

data bits and parity 4.39

dead band 8.3

dead band A 5.12

dead band B 5.17

decimal 1 4.6

decimal 2 4.11

Declaration of Conformity A.10

default 6.15

derivative, output 1A or 2A 5.11

derivative, output 1B or 2B 5.16

Diagnostics Menu 6.8 - 6.12

diagnostics menu lockout 6.6

DIP switch locations and functions

1.1 - 1.4

Display key 3.1

Display Loop ii, 3.2

display loop parameters 3.2

display, lower 3.1..

display, upper 3.1

Down-arrow key 3.1

dual switched dc 2.10, 2.11, 2.12,  
2.13

## E

error code actions 7.7 - 7.8

error code E1 & E2 messages 7.6

error latching 4.34

event input 1 2.4, 4.34

event input 1 status 5.4

external transmitter power supply

2.12, 2.13

## F

failure mode 4.33

Factory Menus iii. 6.1 - 6.15

front panel lockout 6.3

factory ship date 6.9

factory use only prompts 6.10

## G

Global Menu 4.32 - 4.36

global menu lockout 6.5

## H

hardware setup 1.1 - 1.4

humidity sensors 4.3 - 4.4

hysteresis 1A 4.18

hysteresis 1B 4.21

hysteresis 2A 4.20

hysteresis 2B 4.22

hysteresis 3 4.25

hysteresis 4 4.28

## I

input 1 4.5 - 4.6

input 2 4.10

Input Menu 4.2 - 4.14

input menu lockout 6.5

input module types 6.10

input-to-output isolation 2.4

installation 2.1 - 2.3

integral, output 1A or 2A 5.10

integral, output 1B or 2B 5.15

interface type 4.40

## L

latching (alarm) 3 4.26

latching (alarm) 4 4.28

linearization 2 4.14

lower display 3.1

## M

manual operation 7.3 - 7.4

manual tuning 7.2, 7.3

menu maps ii - iii

Mode key 3.1

model number A.9

## O

Operation Menus ii, 5.1 - 5.17

ordering information A.9

output 1A 4.17

output 1B 4.21

output 2A 4.19

output 2B 4.22

output 3 4.23

output 3 alarm jumper 7.4 - 7.5

output 3 status 5.4

output 3 wiring 2.12

output 4 4.27

output 4 status 5.4

output 4 wiring 2.13

Output Menu 4.16 - 4.31

output menu lockout 6.5

output module types 6.11

## P

Panel Lockout Menu 6.2

PID A menu lockout 6.4

PID A menus 5.8 - 5.12

PID B menu lockout 6.4

PID B menus 5.13 - 5.17

power wiring 2.4

process 3 4.30

process A 3.2, 4.20

process B 3.2, 4.23

process input 2.4, 2.5

process retransmit 2.12

proportional band adjustment 7.2

# Index

proportional band, output 1A 5.9  
proportional band, output 1B 5.14  
proportional band, output 2A 5.9  
proportional band, output 2B 5.14  
protocol type 4.40

## R

ramping function, channel A 4.35  
ramping function, channel B 4.36  
ramp rate, channel A 4.36  
ramp rate, channel B 4.36  
range high 1 4.7 - 4.8  
range low 1 4.7 - 4.8  
range high 2 4.11 - 4.12  
range low 2 4.11 - 4.12  
rate/derivative adjustment 7.3  
rate, output 1A or 2A 5.11  
rate, output 1B or 2B 5.16  
reset/integral adjustment 7.3  
reset, output 1A or 2A 5.10  
reset, output 1B or 2B 5.15  
restore 6.15  
retransmit 8.2  
retransmit calibration offset 4.31  
retransmit high limit 4.31  
retransmit low limit 4.30  
returns A.1  
Rotronic humidity sensor 4.4  
RTD, 2 or 3 wire 2.8, 2.9  
RTD calibration curve 1 4.9  
RTD calibration curve 2 4.13  
RTD input 2.4

## S

safety information inside front cover  
sensor installation guidelines 2.4  
serial number 6.9  
set point 2A 5.3  
set point 2B 5.3  
Setup Menu iii, 4.1 - 4.40  
shipping claims A.1  
silencing (alarms) 3 4.26  
silencing (alarms) 4 4.29  
specifications A.8  
software filter 1 4.9  
software filter 2 4.14  
software revision 6.9  
switched dc 2.12, 2.13  
System Menu 5.2 - 5.7  
system menu lockout 6.4

## T

technical assistance inside front cover  
temperature - relative humidity operation 4.3  
temperature-temperature operation 4.4  
test displays 6.12  
test outputs 6.12  
thermocouple 2.8, 2.9  
thermocouple input 2.4  
transmitter power supply 8.3  
tuning 7.2

## U

units parameter 3.2  
universal signal input switches 1.6  
Up-arrow key 3.1  
upper display 3.1

## V

Vaisala humidity sensor 4.3

## W

warranty A.1  
Watlow Controls A.1  
wet bulb/dry bulb 4.3  
wiring 2.4 - 2.13  
wiring example 2.6  
wiring notes 2.7



## A

**A3HI** alarm 3 high 5.5  
**A3LO** alarm 3 low 5.5  
**A4HI** alarm 4 high 5.6  
**A4LO** alarm 4 low 5.6  
**ACAL** retransmit calibration offset 4.31  
**Addr** address 4.40  
**AL3** alarm 3 4.24  
**AL4** alarm 4 4.27  
**ALT** altitude compensation 4.14  
**AP7b** ambient temperature 6.9  
**Annun** annunciator 4.35  
**ANout** analog output 4.29  
**ARH** retransmit high limit 4.31  
**ARL** retransmit low limit 4.30  
**ATSP** auto-tune set point 4.35  
**AUT** auto-tune 5.7

## B

**BAUD** baud rate 4.39

## C

**CF** celsius-fahrenheit 4.33  
**CAL** calibration menu 6.6, 6.14  
**CAL1** calibration offset 1 4.8  
**CAL2** calibration offset 2 4.13  
**COMM** Communications Menu 4.38  
**COMM** communications menu lockout 6.6  
**CT1A** cycle time, output 1A 5.12  
**CT1B** cycle time, output 1B 5.17  
**CT2A** cycle time, output 2A 5.12  
**CT2B** cycle time, output 2B 5.17

## D

**DATAB** data bits and parity 4.39  
**DATE** factory ship date 6.9  
**db A** dead band A 5.12  
**db B** dead band B 5.17  
**DE1A** derivative, output 1A 5.11  
**DE1B** derivative, output 1B 5.16  
**DE2A** derivative, output 2A 5.11  
**DE2B** derivative, output 2B 5.16  
**DEC1** decimal 1 4.6  
**DEC2** decimal 2 4.11  
**DFL** default 6.15  
**DIAG** Diagnostics Menu 6.8  
**DIAG** diagnostics menu lockout 6.6  
**DISP** test displays 6.12

## E

**E11** event input 1 4.34  
**E1S** event input 1 status 5.4  
**ERR** error latching 4.34

## F

**FAIL** failure mode 4.33  
**FTR1** software filter 1 4.9  
**FTR2** software filter 2 4.14

## G

**GLBL** Global Menu 4.32  
**GLBL** global menu lockout 6.5

## H

**HY1A** hysteresis 1A 4.18  
**HY2A** hysteresis 2A 4.20  
**HY1B** hysteresis 1B 4.21  
**HY2B** hysteresis 2B 4.22  
**HYS3** hysteresis 3 4.25  
**HYS4** hysteresis 4 4.28

## I

**I11** input 1 4.5 - 4.6  
**I12** input 2 4.10  
**INPT** Input Menu 4.2  
**INPT** input menu lockout 6.5  
**INTF** interface type 4.40  
**IT1A** integral, output 1A 5.10  
**IT1B** integral, output 1B 5.15  
**IT2A** integral, output 2A 5.10  
**IT2B** integral, output 2B 5.15  
**ITY1** input 1 module type 6.10  
**ITY2** input 2 module type 6.10

## L

**LAL3** latching 3 4.26  
**LAL4** latching 4 4.28  
**L1N2** linearization 2 4.14  
**LOC** front panel lockout 6.3

## O

**OE1A** output 1A 4.17  
**OE1B** output 1B 4.21  
**OE2A** output 2A 4.19  
**OE2B** output 2B 4.22  
**OE3** output 3 4.23  
**OE3S** output 3 status 5.4  
**OE4** output 4 4.27  
**OE4S** output 4 status 5.4  
**OEPE** Output Menu 4.16  
**OEPE** output menu lockout 6.5  
**OEY1** output 1 module type 6.11  
**OEY2** output 2 module type 6.11  
**OEY3** output 3 module type 6.11  
**OEY4** output 4 module type 6.11

## P

**PB1A** proportional band, output 1A 5.9

**PB1B** proportional band, output 1B 5.14  
**PB2A** proportional band, output 2A 5.9  
**PB2B** proportional band, output 2B 5.14  
**P1dA** Channel A PID Menu 5.8  
**P1dA** PID A menu lockout 6.4  
**P1dB** Channel B PID Menu 5.13  
**P1dB** PID B menu lockout 6.4  
**PLOC** Panel Lockout Menu 6.2  
**PRC3** process 3 4.30  
**PRCA** process A 4.20  
**PRCB** process B 4.23  
**PROT** protocol type 4.40

## R

**RA1A** rate, output 1A 5.11  
**RA1B** rate, output 1B 5.16  
**RA2A** rate, output 2A 5.11  
**RA2B** rate, output 2B 5.16  
**RE1A** reset, output 1A 5.10  
**RE1B** reset, output 1B 5.15  
**RE2A** reset, output 2A 5.10  
**RE2B** reset, output 2B 5.15  
**RH1** range high 1 4.7 - 4.8  
**RH2** range high 2 4.11 - 4.12  
**RL1** range low 1 4.7 - 4.8  
**RL2** range low 2 4.11 - 4.12  
**RP A** ramping function for channel A 4.35  
**RP B** ramping function for channel B 4.36  
**RA A** ramp rate for channel A 4.36  
**RA B** ramp rate for channel B 4.36  
**RTD1** RTD calibration curve 1 4.9  
**RTD2** RTD calibration curve 2 4.13  
**RSE** restore 6.15

## S

**SIL3** silencing 3 4.26  
**SIL4** silencing 4 4.29  
**SN--** serial number 6.9  
**SOFT** software revision 6.9  
**SP2A** set point 2A 5.3  
**SP2B** set point 2B 5.3  
**SY5** System Menu 5.2  
**SY5** system menu lockout 6.4

## T

**TOUT** test outputs 6.12

# Specifications

## Specifications — (1908)

### Control Mode

- Dual input, six output, optional retransmit of set point or process variable.
- Programmable direct- and reverse-acting control outputs per channel.
- One-step auto-tuning.

### Agency Approvals

- UL #873, c-UL File #43684.
- NEMA 4X (IP65) front panel.
- 89/336/EEC Electromagnetic Compatibility Directive:
- EN 55011: 1991 Group 1, Class A Emissions.
- EN 50082-2: 1994 Immunity.
- 73/23/EEC Low Voltage Directive:
- EN 61010-1: 1993 Safety.

### Operator Interface

- Dual, four digit LED displays.  
Upper: 0.4 inch (10 mm).  
Lower: 0.3 inch (8 mm).
- Mode, Auto/Man, Display, Up and Down keys.

### Accuracy

- Calibration accuracy and sensor conformity:  $\pm 0.1\%$  of span,  $\pm 1$  LSD,  $77^\circ\text{F} \pm 5^\circ\text{F}$  ( $25^\circ\text{C} \pm 3^\circ\text{C}$ ) ambient and rated line voltage  $\pm 10\%$ .
- Accuracy span:  $1000^\circ\text{F}$  ( $540^\circ\text{C}$ ) minimum.
- Temperature stability:  $\pm 0.2^\circ\text{F}/^\circ\text{F}$  ( $0.1^\circ\text{C}/^\circ\text{C}$ ) change in ambient.
- Voltage stability:  $\pm 0.01\%$  of span /% of rated line voltage.

### Sensors/Inputs

- Contact input for software function select (event input).
- Thermocouple Types B, C<sup>2</sup>, D<sup>2</sup>, E, J, K, N, R, S, T and Pt 2<sup>2</sup>.
- RTD resolution in  $1^\circ$  or  $0.1^\circ$  RTD scales.
- Process variables: 0-20mA, 4-20mA, 0-5V<sub>rms</sub> (dc), 1-5V<sub>rms</sub> (dc), and 0-10V<sub>rms</sub> (dc).
- Sensor break protection de-energizes system for safety. Latching or non-latching.
- Selectable display of  $^\circ\text{F}$ ,  $^\circ\text{C}$  or process units.

### Input Range

Specified temperature ranges represent the controller's operational span.

#### • Thermocouple

Available with basic or universal signal conditioner

Type C <sup>2</sup>	32 to 4200°F	(0 to 2316°C)
Type D <sup>2</sup>	32 to 4200°F	(0 to 2316°C)
Type E	-328 to 1470°F	(-200 to 799°C)
Type J	32 to 1500°F	(0 to 816°C)
Type K	-328 to 2500°F	(-200 to 1371°C)
Type N	32 to 2372°F	(0 to 1300°C)
Type T	-328 to 750°F	(-200 to 399°C)
Pt 2 <sup>2</sup>	32 to 2543°F	(0 to 1395°C)

Available with universal signal conditioner

Type B	1598 to 3300°F	(870 to 1816°C)
Type R	32 to 3200°F	(0 to 1760°C)
Type S	32 to 3200°F	(0 to 1760°C)

•

### RTD Resolution (DIN or JIS)

$1^\circ$ (DIN)	-328 to 1472°F	(-200 to 800°C)
$1^\circ$ (JIS)	-328 to 1166°F	(-200 to 630°C)
$0.1^\circ$ (DIN and JIS)	-99.9 to 999.9°F	(-73.3 to 537.7°C)

### • Process

-999 to 9999 units for all: 0-5V<sub>rms</sub> (dc); 1-5V<sub>rms</sub> (dc); 0-10V<sub>rms</sub> (dc); 0-20mA; and 4-20mA.

### Output Options

- Dual solid-state relay, Form A, 0.5A @ 24V~ (ac) min., 253V~ (ac) max., opto-isolated, burst fire switching. Without contact suppression. Off-state output impedance: 31M $\Omega$ .
- Dual switched dc signal provides a minimum turn-on voltage of 3V<sub>rms</sub> (dc) into a minimum 500 $\Omega$  load; maximum on voltage not greater than 32V<sub>rms</sub> (dc) into an infinite load.
- Dual electromechanical relay<sup>2</sup>, Form A, 2A @ 120/240V~ (ac), 2A @ 28V<sub>rms</sub> (dc), 1/8 hp. @ 120V~ (ac), 125VA @ 120V~ (ac). Without contact suppression.
- Process, 0-20mA, 4-20mA into 800 $\Omega$  maximum, 0-5V<sub>rms</sub> (dc), 1-5V<sub>rms</sub> (dc) or 0-10V<sub>rms</sub> (dc) into 1k $\Omega$  minimum load, isolated.
- Electromechanical relay<sup>2</sup>, Form A/B, 5A @ 120/240V~ (ac), 6A @ 28V<sub>rms</sub> (dc), 1/8 hp. @ 120V~ (ac), 125VA @ 120V~ (ac). Without contact suppression.
- External transmitter power supply, 5, 12 or 20V<sub>rms</sub> (dc) @ 30mA.
- EIA/TIA-232 communications or EIA/TIA-485, EIA/TIA-422 communications, opto-isolated.
- Retransmit: 0-20mA, 4-20mA with 600 $\Omega$  max. load impedance, or 0-5V<sub>rms</sub> (dc), 1-5V<sub>rms</sub> (dc) and 0-10V<sub>rms</sub> (dc) with 500 $\Omega$  min. load impedance.

### Line Voltage/Power

- 100-240V<sub>rms</sub>(ac/dc) +10%, -15%; 50/60Hz,  $\pm 5\%$ .
- 24 to 28V<sub>rms</sub>(ac/dc) +10%, -15%; 50/60Hz,  $\pm 5\%$ .
- Fused internally (factory replaceable only) Slo-Blo<sup>®</sup> type (time-lag): 2A, 250V for high-voltage versions; 5A, 250V for low-voltage versions.
- Power consumption 16VA maximum.
- Non-volatile memory retains data if power fails.

### Operating Environment

- 32 to 149°F (0 to 65°C).
- 0 to 90% RH, non-condensing.

### Storage Temperature

- -40 to 185°F (-40 to 85°C).

### Terminals

- #6 compression universal head screws, accepts 20-14 gauge wire.

### Controller Weight

- 1.0 lb (0.45 kg).

### Shipping Weight

- 3.01 lbs (1.35 kg).

### Sample/Update Rates

- 2 inputs: 5Hz.
- Retransmit: 1Hz.
- PID: 10Hz.
- Control outputs: 10Hz.
- Alarm outputs: 1Hz.
- Display: 2Hz.

### Resolution

- Inputs: 16 bits.

To order, complete the code number with the information below:

# Model Number

**9 9 D - - - - -**

**Series 998**

**Power Supply & Mounting**

- 6 = 24 to 28V $\approx$  (ac/dc) nominal, vertical mounting
- 7 = 24 to 28V $\approx$  (ac/dc) nominal, horizontal mounting
- 8 = 100 to 240V $\approx$  (ac/dc) nominal, vertical mounting
- 9 = 100 to 240V $\approx$  (ac/dc) nominal, horizontal mounting

**Software**

- D = Dual-channel hardware

**Channel A Input**

- 1 = Basic thermocouple signal conditioner (excluding Type B, R, and S)
- 2 = Universal signal conditioner (see range information)

**Channel B Input**

- 1 = Basic thermocouple signal conditioner (excluding Type B, R, and S)
- 2 = Universal signal conditioner (see range information)

**Channel A Output**

- C = Dual switched dc, isolated
- E = Dual electromechanical relay<sup>1</sup>, Form A, 2A without contact suppression
- F = Single, universal process, 0-5V $\approx$  (dc), 1-5V $\approx$  (dc), 0-10V $\approx$  (dc), 0-20mA $\approx$  (dc), 4-20mA $\approx$  (dc), isolated
- K = Dual solid-state relay, Form A, 0.5A, without contact suppression

**Channel B Output**

- C = Dual switched dc, isolated
- E = Dual electromechanical relay<sup>1</sup>, Form A, 2A without contact suppression
- F = Single, universal process, 0-5V $\approx$  (dc), 1-5V $\approx$  (dc), 0-10V $\approx$  (dc), 0-20mA $\approx$  (dc), 4-20mA $\approx$  (dc), isolated
- K = Dual solid-state relay, Form A, 0.5A, without contact suppression

**Output 3**

- A = None
- B = Solid-state relay, Form A, 0.5A, with RC suppression
- C = Switched dc, isolated
- J = Electromechanical relay<sup>2</sup>, Form A or B, 5A without contact suppression
- K = Solid-state relay, Form A, 0.5A without contact suppression
- M = Retransmit, 0-20mA $\approx$  (dc), 4-20mA $\approx$  (dc)
- N = Retransmit, 0-5V $\approx$  (dc), 1-5V $\approx$  (dc), 0-10V $\approx$  (dc)
- T = External signal conditioner power supply, 5, 12 or 20V $\approx$  (dc) @ 30mA

**Output 4**

- A = None
- B = Solid-state relay, Form A, 0.5A, with RC suppression
- C = Switched dc or open collector, isolated
- D = Electromechanical relay<sup>2</sup>, Form C, 5A with RC suppression
- E = Electromechanical relay<sup>2</sup>, Form C, 5A without contact suppression
- K = Solid-state relay, Form A, 0.5A without contact suppression
- R = EIA/TIA-232 communications, opto-isolated
- S = EIA/TIA-485, EIA/TIA-422 communications, opto-isolated
- U = EIA/TIA-232, EIA/TIA-485 communications, opto-isolated
- T = External signal conditioner power supply, 5, 12 or 20V $\approx$  (dc) @ 30mA

**Display Color (Upper/Lower)**

- GG = Green/Green
- GR = Green/Red
- RG = Red/Green
- RR = Red/Red
- XX = Custom overlays, parameters, or software

**NOTE: User documentation may be available in French, German, Spanish, Italian and Dutch, as well as English. Check Watlow's website ([www.watlow.com/](http://www.watlow.com/)) for availability. Specify language at time of order.**

<sup>1</sup> Electromechanical relays warranted for 100,000 closures only. Solid-state switching devices recommended for applications requiring fast cycle times or extended service life.

<sup>2</sup> Not an ANSI symbol.

UL<sup>®</sup> is a registered trademark of the Underwriters Laboratories, Inc.

Slo-Blo<sup>®</sup> is a registered trademark of Littelfuse, Inc.

# Declaration of Conformity

## Series 996, 997, 998, 999

WATLOWCONTROLS

1241 Bundy Boulevard

Winona, Minnesota 55987 USA



Declares that the following product:

English

Designation: Series 996, 997, 998, 999  
Model Number(s): 9 9 (6 7 8 or 9) (Any letter) - (1 or 2) (1 or 2) (C E F or K) (C E F or K) - (A B C J K M N or T) (A B C D E K R S or T) (Any two letters)  
Classification: Control, Installation Category II, Pollution Degree II  
Rated Voltage: 100 to 240V~ or 24 to 28V~  
Rated Frequency: 50/60 Hz  
Rated Power Consumption: 16VA maximum

Meets the essential requirements of the following European Union Directive(s) using the relevant section(s) of the normalized standards and related documents shown:

### 89/336/EEC Electromagnetic Compatibility Directive

EN 50082-2: 1995 EMC Generic immunity standard, Part 2: Industrial environment

EN 61000-4-2: 1995 Electrostatic discharge  
EN 61000-4-4: 1995 Electrical fast transients  
EN 61000-4-3: 1996 Radiated immunity  
EN 61000-4-6: 1996 Conducted immunity  
ENV 50204: 1995 Cellular phone

EN 50081-2: 1994 EMC Generic emission standard, Part 2: Industrial environment

EN 55011: 1991 Limits and methods of measurement of radio disturbance characteristics of industrial, scientific and medical radio-frequency equipment (Group 1, Class A)

EN 61000-3-2: 1995 Limits for harmonic current emissions  
EN 61000-3-3: 1995 Limitations of voltage fluctuations and flicker

### 73/23/EEC Low-Voltage Directive

EN 61010-1: 1993 Safety requirements for electrical equipment for measurement, control, and laboratory use, Part 1: General requirements

Déclare que le produit suivant :

Français

Désignation : Série 996, 997, 998, 999  
Numéro(s) de modèle(s) : 99 (6, 7, 8 ou 9) (lettre quelconque) - (1 ou 2) (1 ou 2) (C, E, F ou K) (C, E, F ou K) - (A, B, C, J, K, M, N ou T) (A, B, C, D, E, K, R, S ou T) (deux lettres quelconques)  
Classification : Commande, installation catégorie II, degré de pollution II  
Tension nominale : 100 à 240 V ~ ou 24 à 28 V ~  
Fréquence nominale : 50/60 Hz  
Consommation d'alimentation nominale : 16 VA maximum

Conforme aux exigences de la (ou des) directive(s) suivantes de l'Union Européenne figurant aux sections correspondantes des normes et documents associés ci-dessous :

### 89/336/EEC Directive de compatibilité électromagnétique

EN 50082-2 : 1995 Norme générique d'insensibilité électromagnétique, Partie 2 : Environnement industriel

EN 61000-4-2 : 1995 Décharge électrostatique  
EN 61000-4-4 : 1995 Courants électriques transitoires rapides  
EN 61000-4-3 : 1996 Insensibilité à l'énergie rayonnée  
EN 61000-4-6 : 1996 Insensibilité à l'énergie par conduction  
ENV 50204 : 1995 Téléphone cellulaire

EN 50081-2 : 1994 Norme générique sur les émissions électromagnétiques, Partie 2 : Environnement industriel

EN 55011 : 1991 Limites et méthodes de mesure des caractéristiques d'interférences du matériel radiofréquence industriel, scientifique et médical (Groupe 1, Classe A)

EN 61000-3-2 : 1995 Limites d'émission d'harmoniques  
EN 61000-3-3 : 1995 Limitations d'écart de tension et de papillotement

### 73/23/EEC Directive liée aux basses tensions

EN 61010-1 : 1993 Exigences de sécurité pour le matériel électrique de mesure, commande et de laboratoire, Partie 1 : Exigences générales

A.10 WATLOW Series 998 User's Manual

(1231)

Erklärt, daß das folgende Produkt:

Deutsch

Beschreibung: Serie 996, 997, 998, 999  
Modellnummer(n): 9 9 (6 7 8 oder 9) (beliebiger Buchstabe) - (1 oder 2) (1 oder 2) (C E F oder K) (C E F oder K) - (A B C J K M N oder T) (A B C D E K R S oder T) (2 beliebige Buchstaben)  
Klassifikation: Regelsystem, Installationskategorie II, Emissionsgrad II  
Nennspannung: 100 bis 240 V~ oder 24 bis 28 V~  
Nennfrequenz: 50/60 Hz  
Stromverbrauch: Max. 16 VA

Erfüllt die wichtigsten Normen der folgenden Anweisung(en) der Europäischen Union unter Verwendung der untenstehenden einschlägigen Dokumente:

### 89/336/EEC Elektromagnetische Übereinstimmungsanweisung

EN 50082-2: 1995 EMC-Rahmennorm für Störsicherheit, Teil 2: Industrielle Umwelt

EN 61000-4-2: 1995 Elektrostatische Entladung  
EN 61000-4-4: 1995 Elektrische schnelle Stöße  
EN 61000-4-3: 1996 Strahlungsimmunität  
EN 61000-4-6: 1996 Leitungsimmunität  
ENV 50204: 1995 Mobiltelefon

EN 50081-2: 1994 EMC-Rahmennorm für Emissionen, Teil 2: Industrielle Umwelt

EN 55011: 1991 Beschränkungen und Methoden der Messung von Funkstörungsmerkmalen industrieller, wissenschaftlicher und medizinischer Hochfrequenzgeräte (Gruppe 1, Klasse A)

EN 61000-3-2: 1995 Grenzen der Oberwellenstromemissionen  
EN 61000-3-3: 1995 Grenzen der Spannungsschwankungen und Flimmern

### 73/23/EEC Niederspannungsrichtlinie zu entsprechen

EN 61010-1: 1993 Sicherheitsrichtlinien für Elektrogeräte zur Messung, zur Steuerung und im Labor, Teil 1: Allgemeine Richtlinien

Declara que el producto siguiente:

Español

Designación: Serie 996, 997, 998, 999  
Números de modelo: 9 9 (6 7 8 ó 9)(Cualquier letra) - (1 ó 2)(1 ó 2) (C E F o K)(C E F o K) - (A B C J K M N o T) (A B C D E K R S o T)(Cualquier combinación de dos letras)  
Clasificación: Control, categoría de instalación II, grado de contaminación ambiental II  
Tensión nominal: 100 a 240 V ~ o 24 a 28 V ~  
Frecuencia nominal: 50/60 Hz  
Consumo nominal de energía: 16 VA máximo

Cumple con los requisitos esenciales de las siguientes directivas de la Unión Europea, usando las secciones pertinentes de las reglas normalizadas y los documentos relacionados que se muestran:

### 89/336/EEC - Directiva de compatibilidad electromagnética

EN 50082-2: 1995 Norma de inmunidad genérica del EMC, parte 2: Ambiente industrial

EN 61000-4-2: 1995 Descarga electrostática  
EN 61000-4-4: 1995 Perturbaciones transitorias eléctricas rápidas  
EN 61000-4-3: 1996 Inmunidad radiada  
EN 61000-4-6: 1996 Inmunidad conducida  
ENV 50204: 1995 Teléfono portátil

EN 50081-2: 1994 Norma de emisión genérica del EMC, parte 2: Ambiente industrial

EN 55011: 1991 Límites y métodos de medición de características de perturbaciones de radio correspondientes a equipos de radiofrecuencia industriales, científicos y médicos (Grupo 1, Clase A)

EN 61000-3-2: 1995 Límites para emisiones de corriente armónica  
EN 61000-3-3: 1995 Limitaciones de fluctuaciones del voltaje

### 73/23/EEC Directiva de baja tensión

EN 61010-1: 1993 Requerimientos de seguridad para equipos eléctricos de medición, control y uso en laboratorios, Parte 1: Requerimientos generales

Erwin D. Lowell

Name of Authorized Representative

Winona, Minnesota, USA

Place of Issue

General Manager

Title of Authorized Representative

January 24, 1996

Date of Issue

Signature of Authorized Representative

Appendix



**Watlow Series 998 User's Manual**

Watlow Controls, 1241 Bundy Boulevard, P.O. Box 5580, Winona, Minnesota USA 55987-5580  
Phone: (507) 454-5300, Fax: (507) 452-4507 <http://www.watlow.com>