



Series 982

User's Manual

Includes 981, 982, 983 and 984



1/8 DIN Microprocessor-Based, Ramping Controller

User Levels:

- New Usergo to page 1.1
- Experienced Usergo to page 2.1
- Expert Usergo to page 4.1

Installers:

- Set-upgo to page 1.3
- Wiring & Installationgo to page 2.1

CE 96

**TOTAL
CUSTOMER
SATISFACTION**

3 Year Warranty

ISO 9001



Registered Company
Winona, Minnesota USA



WATLOW

Watlow Controls

1241 Bundy Boulevard, P.O. Box 5580, Winona, Minnesota USA 55987-5580
Phone: (507) 454-5300, Fax: (507) 452-4507 <http://www.watlow.com>

0600-0009-0008 Rev P

November 1999

Supersedes: 0600-0009-0008 Rev N

\$10.00

Made in the U.S.A.



Printed on Recycled Paper 10% Postconsumer Waste

About This Manual

How to Use this Manual

We have designed this user's manual to be a helpful guide to your new Watlow controller. The headlines in the upper right and left corners indicate which tasks are explained on that page. If you are a new user, we suggest that you read through the whole manual. If you are experienced, you may want to begin reading on page 2.1.

Notes, Cautions and Warnings

We use note, caution and warning symbols throughout this book to draw your attention to important operational and safety information.

A bold text "**NOTE**" marks a short message in the margin to alert you to an important detail.

A bold text "**CAUTION**" safety alert appears with information that is important for protecting your equipment and performance. **Be especially careful to read and follow all cautions that apply to your application.**

A bold text "**WARNING**" safety alert appears with information that is important for protecting you, others and equipment from damage. **Pay very close attention to all warnings that apply to your application.**

The  symbol (an exclamation point in a triangle) precedes a general CAUTION or WARNING statement.

The  symbol (a lightning bolt in a triangle) precedes an electric shock hazard CAUTION or WARNING safety statement.

Technical Assistance

If you encounter a problem with your Watlow controller, review all of your configuration information for each step of the setup to verify that your selections are consistent with your applications.

If the problem persists after checking all the steps, you can get technical assistance by calling Watlow Controls at (507) 494-5656, between 7 a.m. and 7 p.m. CST, and asking for an applications engineer; or by e-mailing your questions to wintechsupport@watlow.com. When you call, have the following information on hand: the controller's model number (the 12-digit number is printed on the top of the stickers on each side of the controller's case and on the right-hand or top circuit board); your user's manual; all configuration information; and the Diagnostics Menu readings.

Warranty and Returns

For information about the warranty covering the Series 982 Family of controllers see the Appendix.

Comments and Suggestions

We welcome your comments and opinions about this user's manual and the Series 982 Family of controllers. Send them to the Technical Editor, Watlow Controls, P.O. Box 5580, Winona, MN 55987-5580. Or call (507) 454-5300 or fax them to (507) 452-4507. The *Series 982 User's Manual* is copyrighted by Watlow Winona, Inc., © November 1999, with all rights reserved. (1830)

WATLOW Series 982 User's Manual

Chapter 1

Starting Out With the Watlow Series 981/982

- 1.1 Starting Out With the Watlow Series 981/982
- 1.2 Menu Overview
- 1.3 DIP Switch Locations and Functions
- 1.4 Setting the Hardware Lockout DIP Switch
- 1.5 External Power Supply DIP Switches
- 1.6 Input Type DIP Switches

Chapter 2

Install and Wire the Series 981/982

- 2.1 Panel Cutout
- 2.1 Dimensions
- 2.2 Installation Procedure
- 2.3 Wiring the Series 981/982
- 2.4 I/O Isolation
- 2.4 Power Wiring
- 2.4 Sensor Installation Guidelines
- 2.5 Wiring 0-20mA and 4-20mA Process Inputs
- 2.6 Wiring Example
- 2.7 Wiring Notes
- 2.8 Input 1 Wiring
- 2.9 Input 2 Wiring
- 2.9 Digital Event Input 2
- 2.10 Digital Event Input 1
- 2.11 Output 1 Wiring
- 2.12 Output 2 Wiring
- 2.13 Output 3 Wiring
- 2.14 Output 4 Wiring

Chapter 3

Front Panel and Display Loop

- 3.1 Front Panel Guide
- 3.2 Display Loop

Chapter 4

The Setup Menus

- 4.1 Entering the Setup Menus
- 4.2 Input Menu
- 4.3 Input Prompts
- 4.12 Output Menu
- 4.13 Output Prompts
- 4.28 Global Menu
- 4.29 Global Prompts
- 4.38 Communications Menu
- 4.39 Communications Prompts

Chapter 5

The Operation Menus

- 5.1 Entering the Operation Menus
- 5.2 System Menu
- 5.3 System Prompts
- 5.10 PID Menu
- 5.11 PID Prompts

Chapter 6

The Factory Menus

- 6.1 Entering the Factory Menus
- 6.2 Diagnostics Menu and Prompts
- 6.7 Calibration Menu and Prompts

Chapter 7

The Run Menu

- 7.1 Program Menu
- 7.1 Program Prompts
- 7.5 Running a Series 982 Profile
- 7.5 Resume a Profile
- 7.6 Run and Pre-Run Menus
- 7.6 Event Outputs
- 7.7 Guaranteed Soak Deviation
- 7.8 Jump-loops
- 7.8 Programming a Ramping Profile
- 7.10 Running your Profile
- 7.10 Editing your Profile
- 7.12 Linking Profiles
- 7.13 Waitfor Functions
- 7.14 Master Step Chart

Chapter 8

Operation, Tuning, Alarms and Error Codes

- 8.1 Auto-tuning
- 8.2 Manual Tuning
- 8.3 Changing the Output 3 Jumper
- 8.4 Using Alarms
- 8.5 Error Code E1 and E2 Messages
- 8.6 Error Code Actions

Chapter 9

Software

- 9.2 Burst Fire
- 9.4 Communications
- 9.6 Dead Band
- 9.8 Digital Events
- 9.10 Input Filter
- 9.12 Input Linearization
- 9.14 Retransmit
- 9.16 Slidewire Feedback

Appendix

- A.1 Warranty and Returns
- A.2 Glossary
- A.5 Index
- A.8 Specifications
- A.9 Ordering Information
- A.10 Declaration of Conformity

Notes

Chapter 1 Starting Out with the Watlow Series 982



Figure 1.1 - Watlow Ramping Controllers.

Watlow's Series 982, a 1/8 DIN microprocessor-based ramping controller, is truly an innovation in the controller field. The Series 982 provides 6-step program capability, with up to 4 files possible.

The new controller meets a wide variety of needs in the process industries. Its broad range of I/O options allows control of virtually any process variable. In addition to the standard Watlow features, the Series 982 has expanded auto-tuning capabilities and increased alarm functionality.

If you are unfamiliar with general controller operation, it's a good idea to read through the entire manual. The manual is organized in chronological order with each chapter broken down by wiring, menus, operation and applications. If you understand the concept of process/temperature controllers and feel comfortable skipping around through the manual, use the index or the black tabs at the top of each page to quickly scan the pages and find the topic you are looking for.

The map on the next page provides an overview of all menus and prompts and how to navigate between them. There are three main prompts Setup, Operation and Factory (**SEt**, **OPER** and **Fctry**). Beneath these prompts there are several menus. The Display Loop can be reached from anywhere using the Display key.

Menu Overview

Display Loop (Lower Display)

Press **DISPLA** to exit any menu and reach the Display Loop at any time.

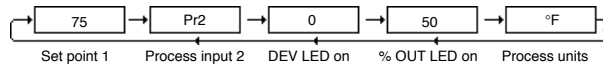

NOTE:
This is a complete listing of all Series 982 prompts.

Not all prompts will appear on your control. They are dependent on your configuration and model number.

Operation Menus

From the Display Loop, press **MODE** to advance to the OPER prompt.

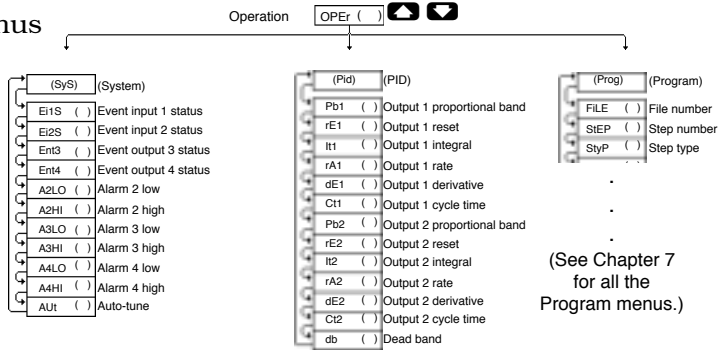

To navigate:

Press **DISPLA** to return to the Display Loop from any location and to advance through the Display Loop.

Press **▲** or **▼** to move between the menus.

Press **MODE** to advance through a menu.

Hold **MODE** while pressing **▲** to move backwards through the menus.

Press **▲** or **▼** to select prompt values.

Setup Menus

From the Display Loop, press **▲** and **▼** for 3 seconds to enter the Setup menus.

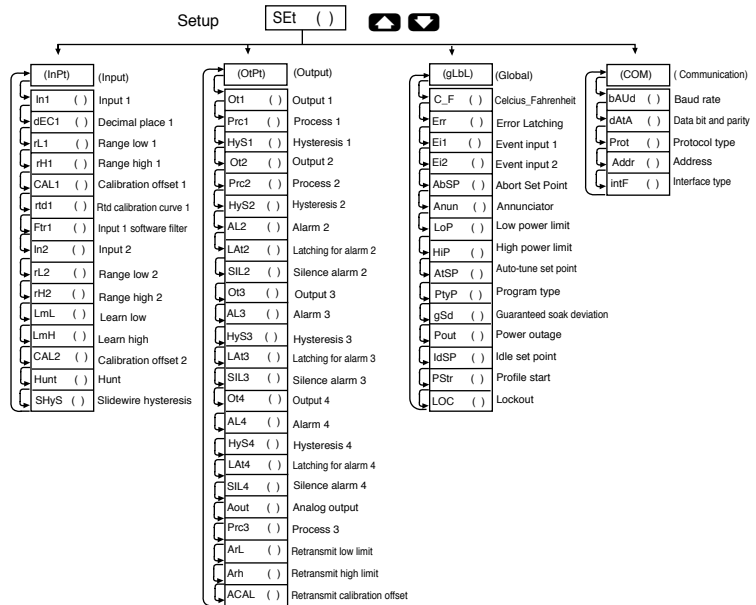

Factory Menus

At the SET prompt, press **▲** and **▼** another 3 seconds to enter the Factory menus.

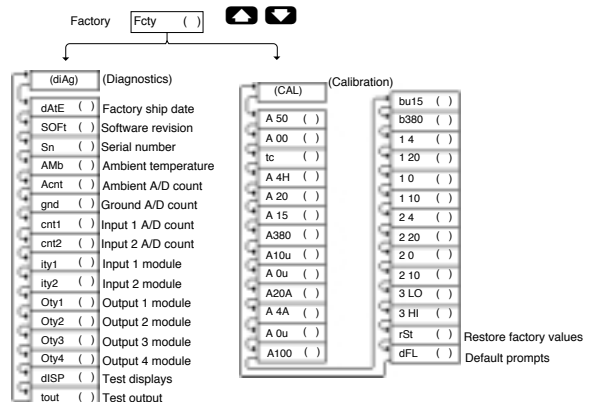

Figure 1.2 - The Series 982 Map.

DIP Switch Locations and Functions

The Series 982 has several Dual In-line Package (DIP) Switches inside the control. Depending on your model number, your unit can have as few as one DIP switch or as many as five DIP switches. Use the rest of this chapter as a DIP switch reference guide.

To set any DIP switch:

1. Remove the control chassis from the case. Release the two tabs on one side of the bezel, by pressing in firmly on each until you hear the tab snap. Release the two tabs on the opposite side of the control. You may need to rock the bezel back and forth several times to release the chassis.
2. Use the following graphics in the rest of the chapter to locate and identify each DIP switch and the desired settings.

Figure 1.3 - Press the release tabs to remove the controller chassis.

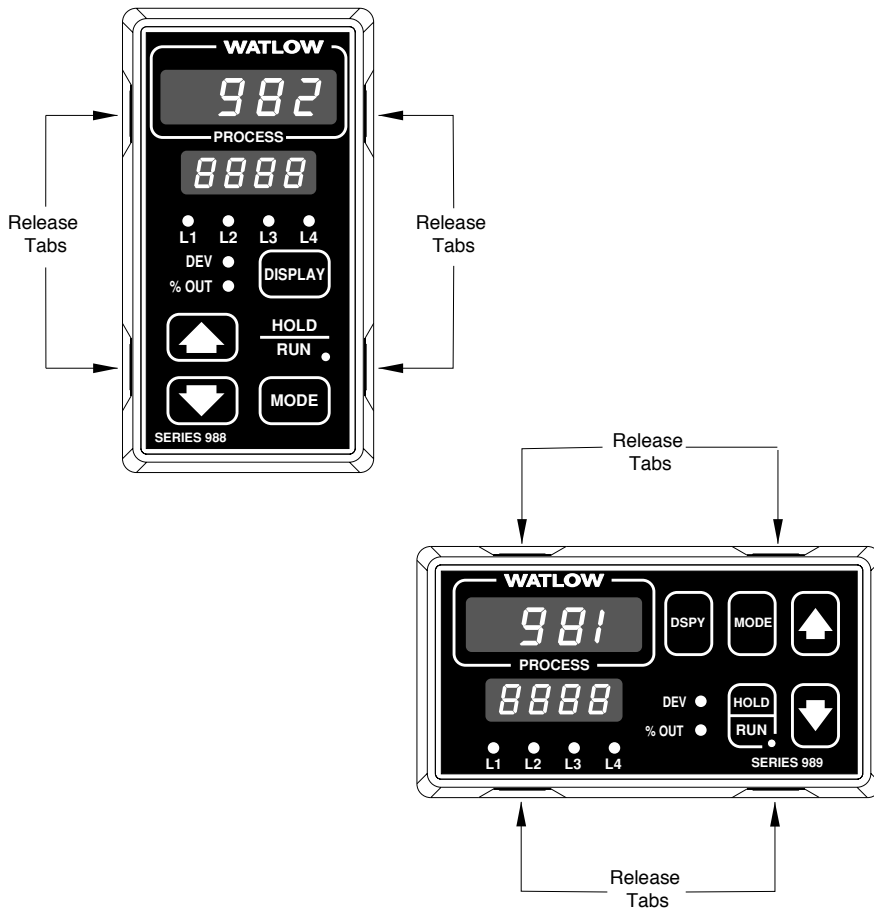

DIP Switches

The Hardware Lockout/Battery Backup DIP Switch

All units are equipped with a DIP switch for hardware lockout of the SEt and Fcty prompt menus, and to enable battery backup of the Run parameters. The location of the board and switch appear below. The switches are clearly numbered, and are labeled on the outside of the board. When Switch #1 is on, battery backup is enabled. When Switch #2 is on, the menus under the SEt prompt (Input, Output, Global and Communications) and Fcty prompt (Diagnostics and Calibration) cannot be viewed. When the control leaves the factory switch #1 is on and switch #2 is off.



CAUTION:
There is danger of an explosion if the battery is incorrectly replaced. This battery is factory replaceable only. Dispose of used batteries according to manufacturer's recommendations.

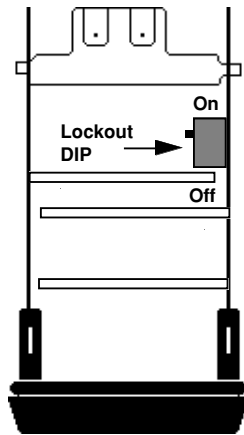

Control Chassis
Top View (982 & 984)
Left-side View (981 & 983)

Figure 1.4 -
Battery backup and
hardware lockout
DIP switches.

battery backup of Run prompts

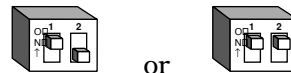

or



lockout Setup and Factory menus

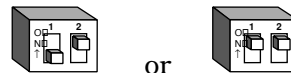

or

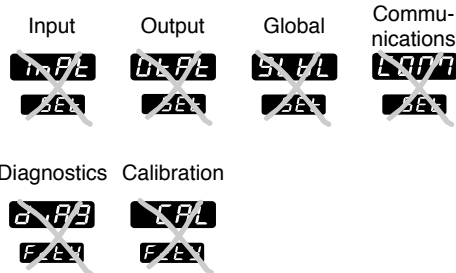

External Power Supply DIP Switches (Option “T”)

Models equipped with an external signal conditioner power supply (Option “T”), have a DIP switch for selecting the power supply voltage. Output 2, 3 or 4 can be ordered with the external power supply. The location of each board and DIP switch appear below. When the control leaves the factory, both switches are off. The figures below show a PC board cutaway for each

DIP switch. See the table to the left for the power supply switch settings. The settings can be used for all three output DIP switches. For other voltage or current ratings contact the factory.

Table 1.5 - Power Supply DIP Switch Settings.

Voltage/Load Current	S 1	S 2
5V ±5% @ 30mA	On	On
12V ±5% @ 30mA	On	Off
20V ±5% @ 30mA	Off	Off

Figure 1.5a - Output 2 External Signal Conditioner Power Supply.

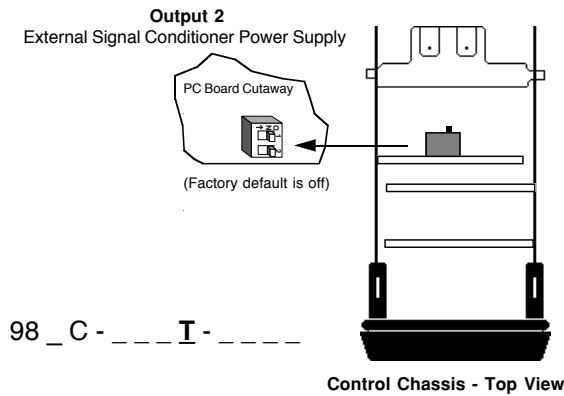

Figure 1.5b - Output 3 External Signal Conditioner Power Supply.

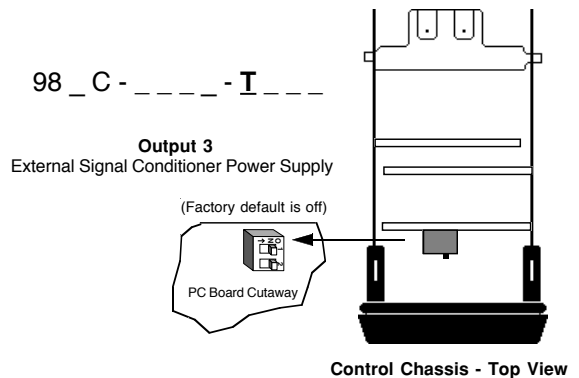
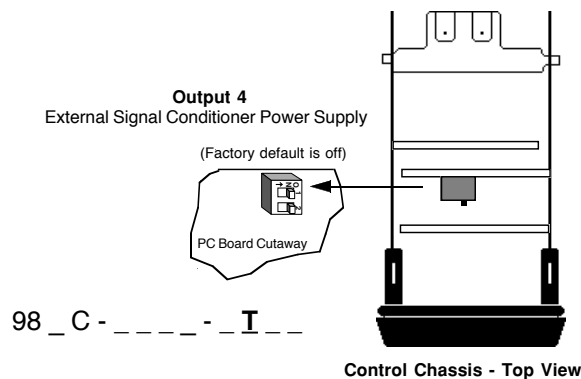

Figure 1.5c - Output 4 External Signal Conditioner Power Supply.



DIP Switches

Universal Signal Input Type DIP Switches

Remove the chassis from the case. Looking at the back of the control, the input #1 (In1) switch is located at the base of the unit. Set the DIP switches to match the appropriate sensor input types will automatically match the DIP switch settings.

If you have model number 98_ C- 1 _ _ _ _ - _ _ _ _ , there is no In1 DIP switch.

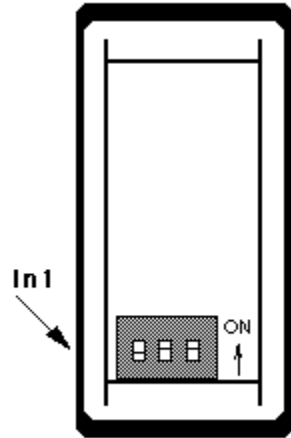

Single Input Unit
98_ C - 2 _ _ _ _ - _ _ _ _

Figure 1.6a -
Input DIP Switch
Locations.

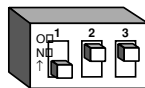

J, K, T, N, C, E, Pt2, D
Thermocouple Input

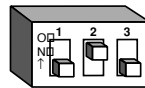

R, S, B
Thermocouple Input

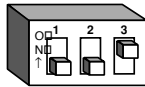

RTD Input

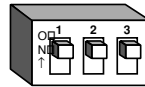

0-20mA or 4-20mA Input

Figure 1.6b -
Input DIP Switch
Settings.

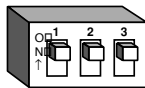

0-5V, 1-5V or 0-10V Input

Chapter 2 Installation and Wiring

NOTE:
Space panel cutouts at least 1.66 inches (42.2mm) apart.

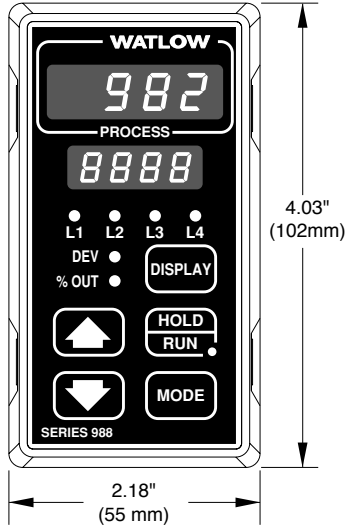

NOTE:
Adjustable mounting brackets can be side-mounted.

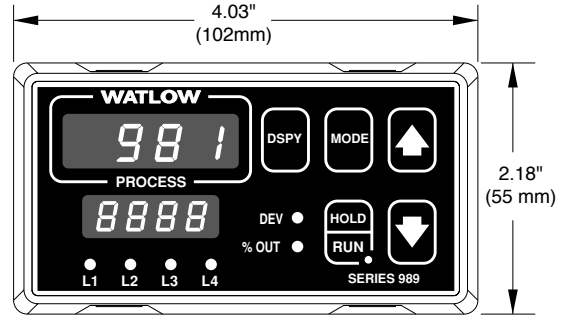

NOTE:
Holes can be cut in the panel using a Greenlee 1/8 DIN Hydraulic Kit #60068 (punch #60069, die #60070).

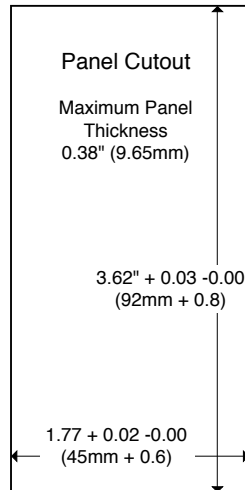
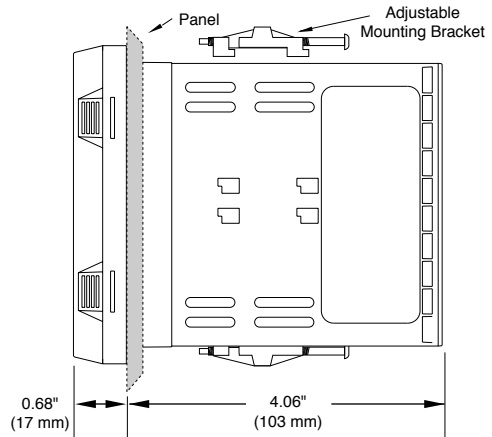

Figure 2.1 - Series 981 and Series 982 dimensions.



Installing the Series 982

Installing and mounting requires access to the back of the panel.

1. Make a panel cutout.
2. To remove the controller chassis from its case, press in firmly on the two tabs on one side or the top of the bezel until they unsnap, then unsnap the two tabs on the opposite side or the bottom. Pull the chassis out of the case by gently rocking it.
3. Slide the case into the panel cutout. Check to see that the gasket is not twisted, and is seated within the case bezel flush with the panel. Slide the mounting collar over the back of the control.

NOTE:
Removing the controller chassis from its case makes mounting easier.

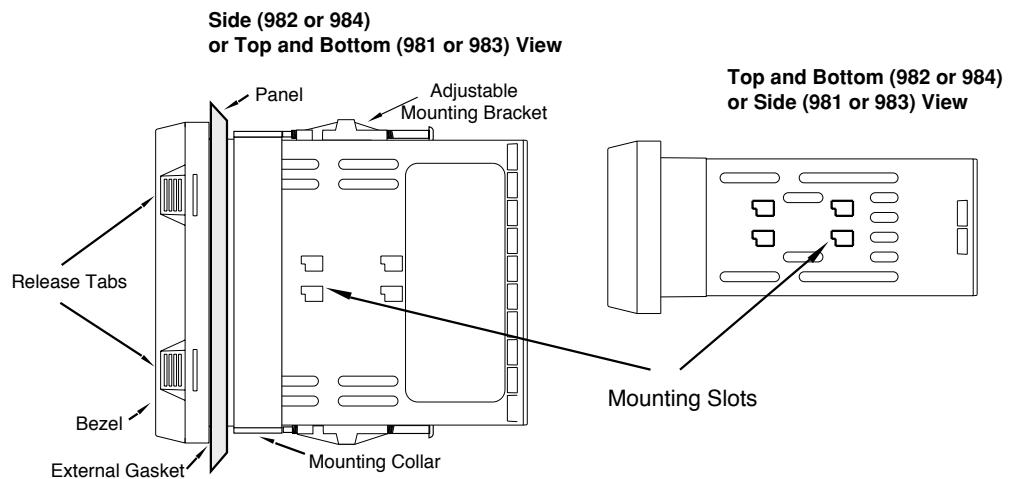

Figure 2.2 - Side and top view.



CAUTION:
Follow the installation procedure exactly to guarantee a proper NEMA 4X seal. Make sure the gasket between the panel and the rim of the case is not twisted and is seated properly. Failure to do so could result in damage to equipment.

4. Loosen the mounting bracket screws enough to allow for the mounting collar and panel thickness. Place each mounting bracket into the mounting slots (head of the screw facing the back of the controller). Push each bracket backward then down to secure it to the control case. **To guarantee a proper NEMA 4X seal, Series 982 and 984 units (vertical) must have the mounting brackets located on either side of the unit. When installing Series 981 and 983 units (horizontal) the brackets must be on the *top and bottom* of the unit.**
5. Make sure the case is seated properly. Tighten the installation screws firmly against the mounting collar to secure the unit. **To ensure a NEMA 4X seal, there should be no space between the bezel and panel.** Overtightening the screws will distort the case and make it difficult to remove or replace the controller.
6. Insert the controller chassis into its case and press the bezel until all four tabs snap. Make sure the inside gasket is seated properly and not twisted.
7. To release the mounting brackets, loosen the mounting bracket screws and push the brackets forward, then pull it up and out.

Wiring



WARNING:
To avoid potential electric shock, use National Electric Code (NEC) safety practices when wiring and connecting this unit to a power source and to electrical sensors or peripheral devices. Failure to do so could result in injury or death.

NOTE:
Input-to-output isolation is defeated when the external signal conditioner power supply option is used to power a transmitter connected to input 1.

Figure 2.4 - Power wiring.



CAUTION:
If high voltage is applied to the low voltage unit, irreversible damage will occur.

Wiring the Series 982

Wiring options depend on the model number and DIP switch settings. Check the terminal designation stickers on either side of the controller and compare your model number to those shown here and with the model number breakdown on the inside back cover of this manual.

Input-to-output Isolation

The Series 982 uses optical isolation between the analog inputs and the controller outputs/digital input. This isolation provides a 500V~ (VAC) barrier to prevent ground loops when using grounded sensors and/or peripheral equipment.

Here is a breakdown of the isolation barriers:

- Analog inputs 1 and 2 are grouped together.
- Outputs 1 through 4 and the standard event input are grouped together. This does not apply to Output 4 when configured as communications.
- The digital communications output (4) is separate from the above groups.

Power Wiring

100 to 240 V~ (ac), nominal (85 to 264 actual)

Horizontal Package	98 1 C - _ _ _ _ - _ _ _ _
Vertical Package	98 2 C - _ _ _ _ - _ _ _ _

24 to 28 V≈ (ac/dc), nominal (21 to 30 actual)

Horizontal Package	98 3 C - _ _ _ _ - _ _ _ _
Vertical Package	98 4 C - _ _ _ _ - _ _ _ _

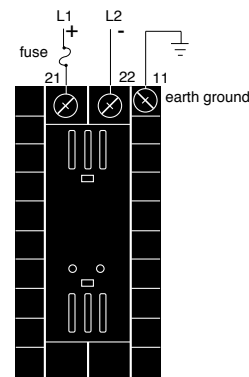

Sensor Installation Guidelines

Thermocouple input: Extension wire for thermocouples must be of the same alloy as the thermocouple itself to limit errors.

100 Ω RTD input: Each 1Ω of lead wire resistance can cause a +2°F error when using a two-wire RTD. A three-wire RTD sensor overcomes this problem. All three wires must have the same electrical resistance (i.e., same gauge, same length, multi-stranded or solid, same metal).

Maintain isolation between input 1 and input 2 to prevent a ground loop. A ground loop may cause incorrect readings, dashes across the upper display or the display of error codes.

Wiring 0-20 and 4-20mA Process Inputs

Certain “transmitters” used in process input applications are producing internal resistor failures in the Watlow Series 988 family of controllers. This is only apparent with the Series 988 family 1/8 DIN units with Process Inputs selected (0-20mA or 4-20mA dc only).

We are noticing that an external resistor is required to prevent a high in-rush current which burns out the Series 988 family controllers’ 7-ohm internal resistor. This high in-rush current occurs initially on “power-up.” If the transmitter turns full on for a split second during power-up, the available current weakens or damages the internal resistor.

Example: $20V / 7 \text{ ohms} = 2,857\text{mA}$ (too much!).

The wiring diagram example below shows an application where a customer is using a 4-20mA dc transmitter and power supply to feed the input of a Series 988 controller. The Rx range (100 to 400 ohms) for the external resistor is recommended. We suggest starting with 250 ohms.

Example: Customer is using a 24V \pm (dc) power supply to power up the 4-20mA dc transmitter that inputs to the Series 988 terminals 8 (-) and 10 (+). To figure out what the internal Series 988’s handling current is for the 0-20mA or 4-20mA dc input to the Series 988 controllers, we need to apply Ohm’s Law: The square root of Watts divided by Resistance equals Current. Applying that formula to the example below produces the following: Square Root of (0.125 Watts / 7 ohms) = 134 mA dc (handling input current). This is the acceptable input current for the Series 988 universal input board.

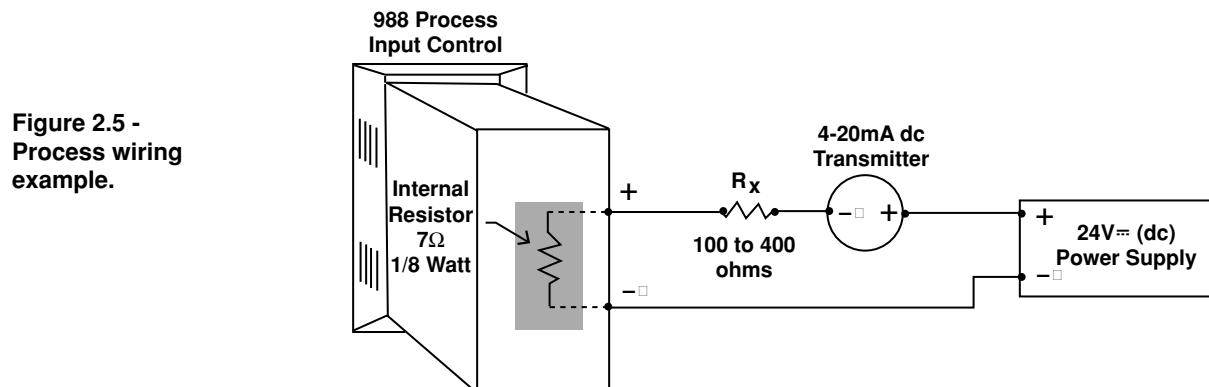

Reminder, the input impedance of 7 ohms handles the majority of our customer applications; the external resistor (Rx) is only for certain transducers/transmitters that spike on power-up or power-down. Please make sure your customer’s transmitter / transducer fall within our Series 988 family (1/8 DIN) of controllers’ Process Input specification of 7 ohms input impedance.

Wiring Example



WARNING:
To avoid potential electric shock, use National Electric Code (NEC) safety practices when wiring and connecting this unit to a power source and to electrical sensors or peripheral devices. Failure to do so could result in injury or death.



WARNING:
Install high or low temperature limit control protection in systems where an over temperature fault condition could present a fire hazard or other hazard. Failure to install temperature limit control protection where a potential hazard exists could result in damage to equipment, property and injury to personnel.



WARNING:
To avoid damage to property and equipment, and/or injury of loss of life, use National Electric Code (NEC) standard wiring practices to install and operate the Series 982. Failure to do so could result in such damage, and/or injury or death.

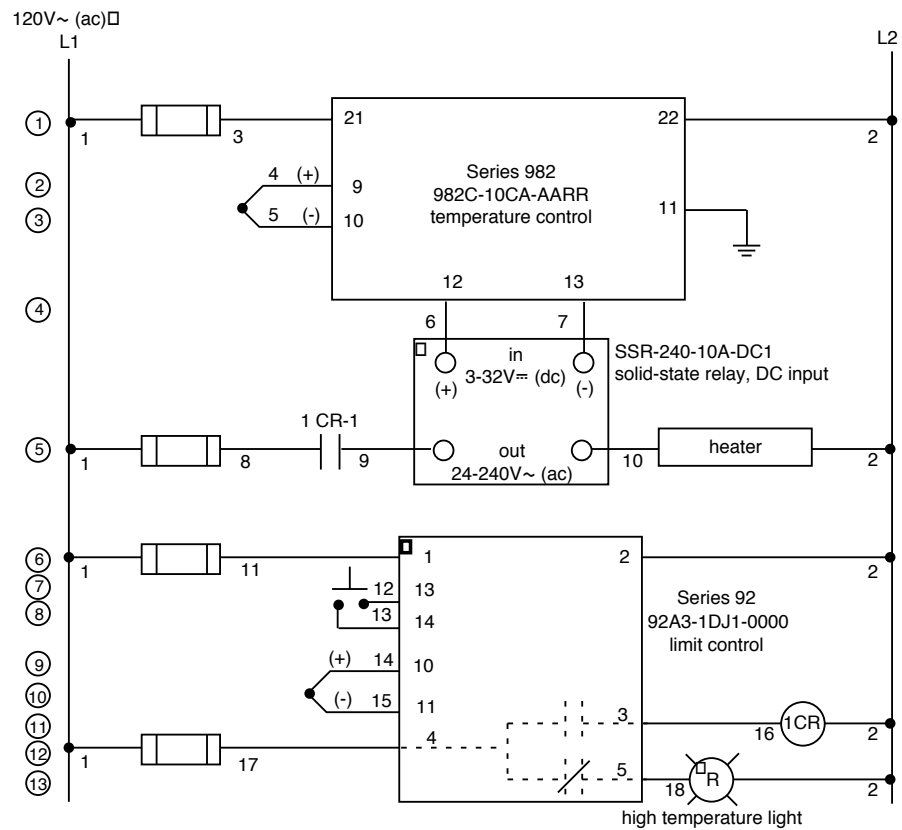
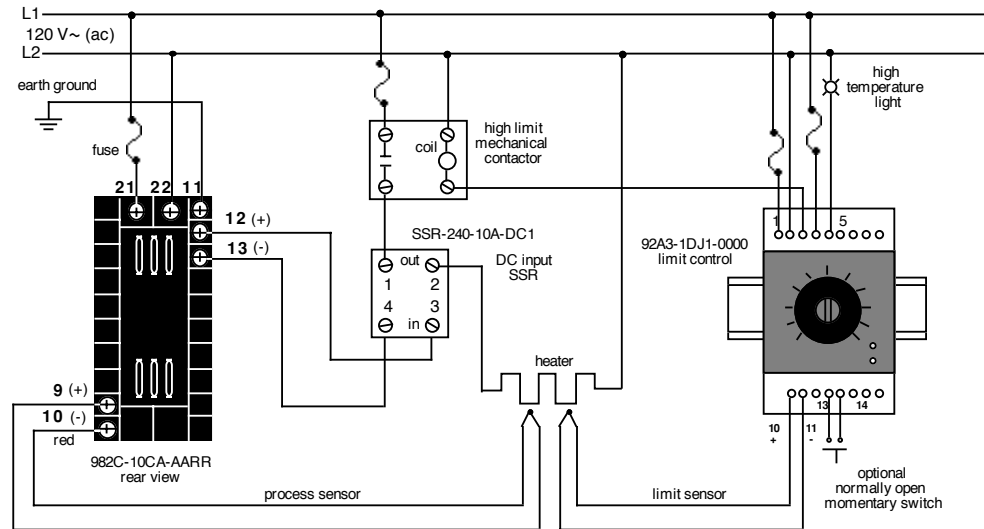

Figure 2.6 - System wiring example.



WARNING:
To avoid damage to property and equipment, and/or injury of loss of life, use National Electric Code (NEC) standard wiring practices to install and operate the Series 982. Failure to do so could result in such damage, and/or injury or death.

NOTE:
Sketch in your application on this page or a copy of it. See wiring examples in this chapter.

Figure 2.7 -
Wiring notes.

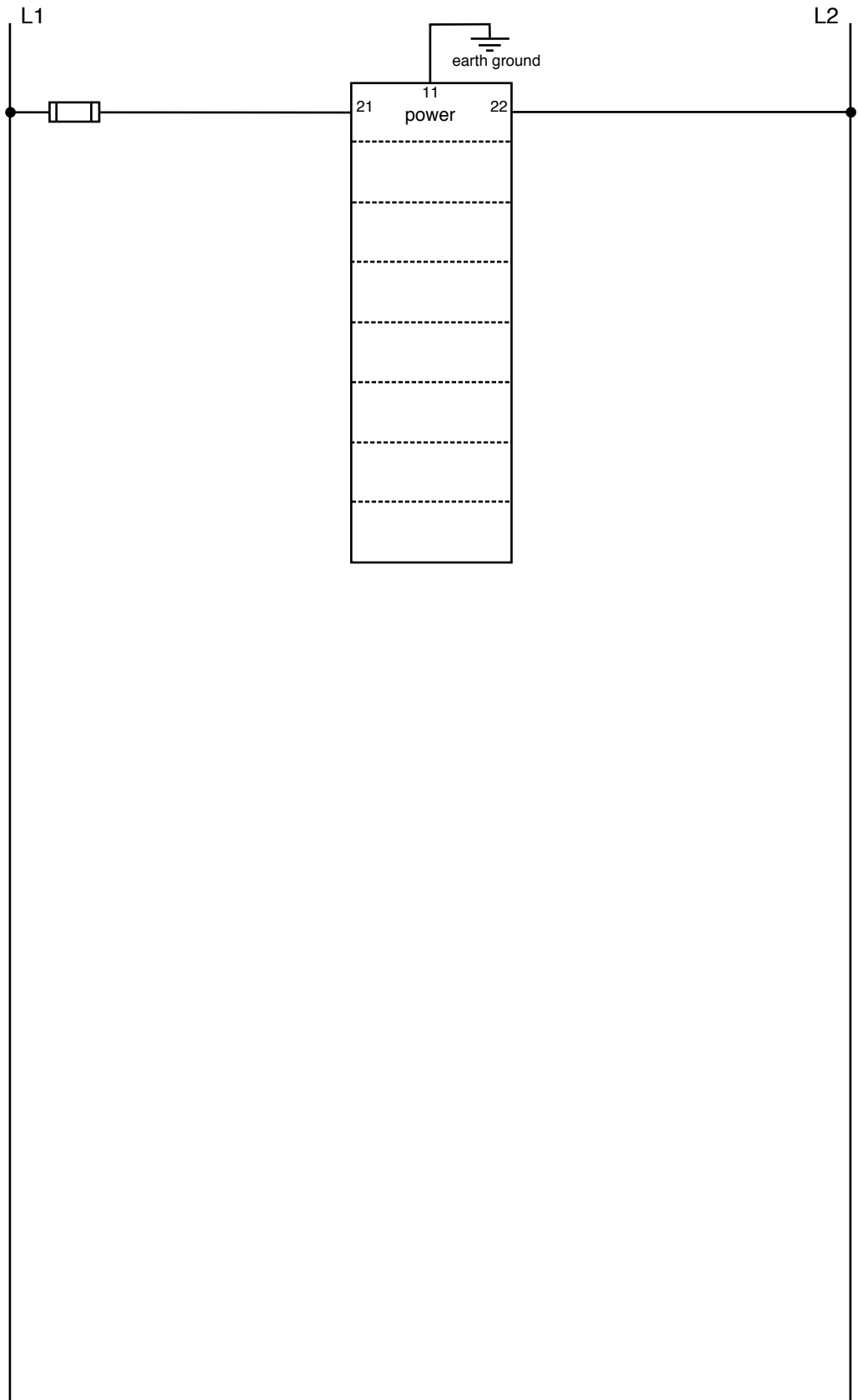

Input 1 Wiring

NOTE:

Successful installation requires five steps:

- Model number and software choice (Appendix);
- DIP switch settings (Chapter 1);
- Sensor match (Chapter 2 and Appendix);
- Sensor installation (Chapter 2); and
- Wiring (Chapter 2).

Figure 2.8a — Thermocouple

Thermocouple only

98 _ C - 1 - - - - - (no DIP switches)

Universal signal conditioner

98 _ C - 2 - - - - -

Input impedance: 20M Ω

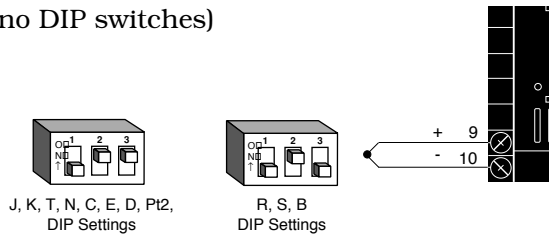
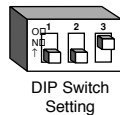

Figure 2.8b — RTD (2- or 3-wire)

Universal signal conditioner

98 _ C - 2 - - - - -



Jumper 9 to 10 for 2-wire RTD

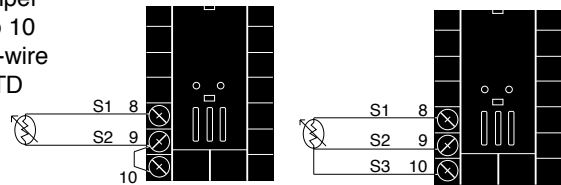
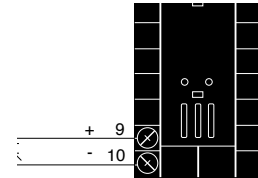
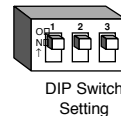

Figure 2.8c — 0-5V_{rms}, 1-5V_{rms} or 0-10V_{rms} (dc) Process

Universal signal conditioner

98 _ C - 2 - - - - -

Input impedance: 10K Ω



CAUTION:

An external resistor is required for 0-20mA and 4-20mA process wiring to prevent a high in-rush current which could burn out the controller's 7-ohm resistor. See page 2.5 for recommendations.

Figure 2.8d — 0-20mA or 4-20mA Process

Universal signal conditioner

98 _ C - 2 - - - - -

Input impedance: 7 Ω

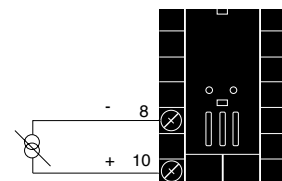
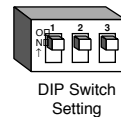
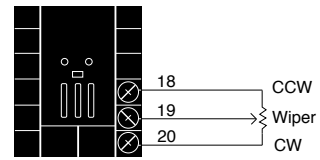

Figure 2.9a — Slidewire Feedback or Potentiometer Input

98_C - 3 - - - - -

Slidewire resistance: 100 to 1,200Ω



NOTE:
See Chapter 9 for information on slidewire feedback.

- NOTE:**
Successful installation requires five steps:
- Model number and software choice (Appendix);
 - DIP switch settings (Chapter 1);
 - Sensor match (Chapter 2 and Appendix);
 - Sensor installation (Chapter 2); and
 - Wiring (Chapter 2).

Figure 2.9b — Digital Event Input 2

98_C - 5 - - - - -

0-3V $\overline{=}$ (dc) Event Input 2 off (open)
14-36V $\overline{=}$ (dc) Event Input 2 on (closed)

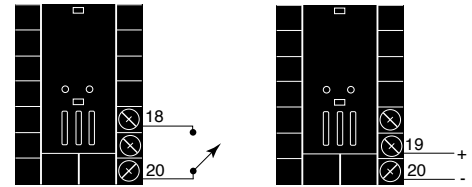
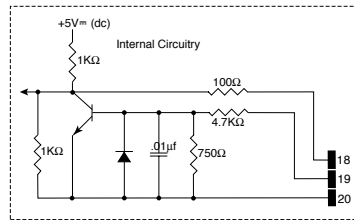

Event Input 1 Wiring

NOTE:

Successful installation requires five steps:

- Model number and software choice (Appendix);
- DIP switch settings (Chapter 1);
- Sensor match (Chapter 2 and Appendix);
- Sensor installation (Chapter 2); and
- Wiring (Chapter 2).

Figure 2.10 — Digital Event Input 1

Available on all units.

14-36V_{ac} (dc) Event Input 1 off (open)
0-3V_{ac} (dc) Event Input 1 on (closed)

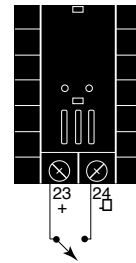
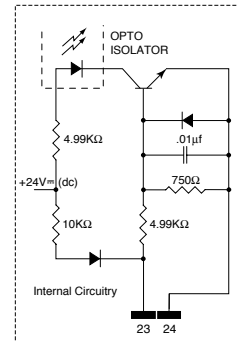

Figure 2.11a — AC Outputs

NOTE:

Successful installation requires five steps:

- Model number and software choice (Appendix);
- DIP switch settings (Chapter 1);
- Sensor match (Chapter 2 and Appendix);
- Sensor installation (Chapter 2); and
- Wiring (Chapter 2).

Solid-state Relay *with* Contact Suppression

98 _ C - _ _ B _ - _ _ _ _
 0.5 amps, minimum off-state impedance: 20KΩ

Electromechanical Relay *with* Contact Suppression

(NO and COM contacts only)
 98 _ C - _ _ _ D _ - _ _ _ _
 Form C, 5 amps, minimum off-state impedance: 20KΩ

Electromechanical Relay *without* Contact Suppression

98 _ C - _ _ _ E _ - _ _ _ _
 Form C, 5 amps off-state impedance: 31MΩ

Solid-state Relay *without* Contact Suppression

98 _ C - _ _ _ K _ - _ _ _ _
 0.5 amps, off-state impedance: 31MΩ

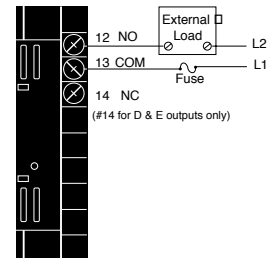

Figure 2.11b — Switched DC, Open Collector

98 _ C - _ _ _ C _ - _ _ _ _

Minimum load resistance: 500Ω

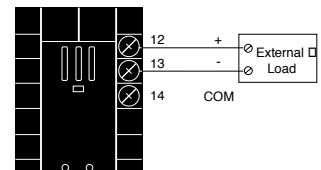
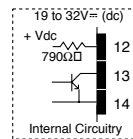

Figure 2.11c — 0-20mA and 4-20mA Process

98 _ C - _ _ _ F _ - _ _ _ _

Maximum load impedance: 800Ω

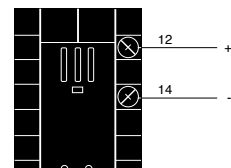
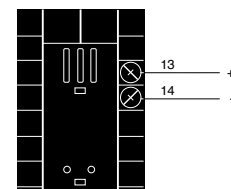

Figure 2.11d — 0-5V_{rms}, 1-5V_{rms} and 0-10V_{rms} (DC) Process

98 _ C - _ _ _ F _ - _ _ _ _

Minimum load impedance: 1KΩ



Output 2 Wiring

Figure 2.12a — AC Outputs

Solid-state Relay with Contact Suppression

98 _ C - _ _ _ _ **B** - _ _ _ _

0.5 amps, minimum off-state impedance: 20KΩ

Electromechanical Relay with Contact Suppression

(NO and COM contacts only)

98 _ C - _ _ _ _ **D** - _ _ _ _

Form C, 5 amps, minimum off-state impedance: 20KΩ

Electromechanical Relay without Contact Suppression

98 _ C - _ _ _ _ **E** - _ _ _ _

Form C, 5 amps off-state impedance: 31MΩ

Solid-state Relay without Contact Suppression

98 _ C - _ _ _ _ **K** - _ _ _ _

0.5 amps, off-state impedance: 31MΩ

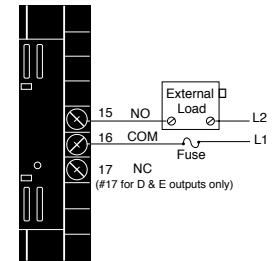

NOTE:

Successful installation requires five steps:

- Model number and software choice (Appendix);
- DIP switch settings (Chapter 1);
- Sensor match (Chapter 2 and Appendix);
- Sensor installation (Chapter 2); and
- Wiring (Chapter 2).

Figure 2.12b — Switched DC, Open Collector

98 _ C - _ _ _ _ **C** - _ _ _ _

Minimum load resistance: 500Ω

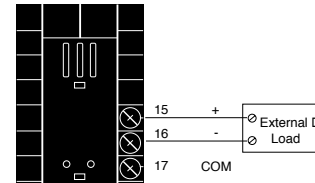
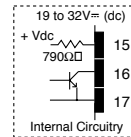

NOTE:

This output cannot be configured as an event output.

Figure 2.12c — 0-20mA and 4-20mA Process

98 _ C - _ _ _ _ **F** - _ _ _ _

Maximum load impedance: 800Ω

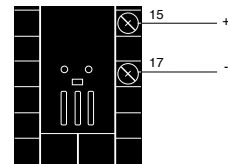

NOTE:

If **SL1d** is selected for **ln2**, **0t2** prompt will not appear.

Figure 2.12d — 0-5V_{rms}, 1-5V_{rms} and 0-10V_{rms} (DC) Process

98 _ C - _ _ _ _ **F** - _ _ _ _

Minimum load impedance: 1KΩ

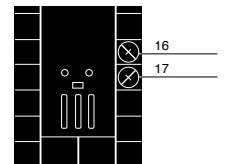

NOTE:

Input-to-output isolation is defeated when the external signal conditioner power supply is used to power a transmitter connected to input 1.

Figure 2.12e — External Signal Conditioner Power Supply

98 _ C - _ _ _ _ **T** - _ _ _ _

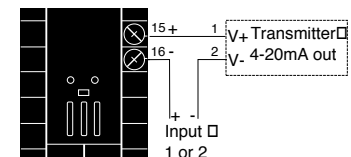

NOTE:

See Chapter 1 for DIP switch location and settings.

Figure 2.13a — AC Outputs

NOTE:
Successful installation requires five steps:

- Model number and software choice (Appendix);
- DIP switch settings (Chapter 1);
- Sensor match (Chapter 2 and Appendix);
- Sensor installation (Chapter 2); and
- Wiring (Chapter 2).

Solid-state Relay *with* Contact Suppression

98 _ C - _ _ _ _ - **B** _ _ _ _
 0.5 amps, minimum off-state impedance: 20KΩ

Electromechanical Relay *without* Contact Suppression

98 _ C - _ _ _ _ - **J** _ _ _ _
 Form A or B, 5 amps, off-state impedance: 31MΩ

Solid-state Relay *without* Contact Suppression

98 _ C - _ _ _ _ - **K** _ _ _ _
 0.5 amps, off-state impedance: 31MΩ

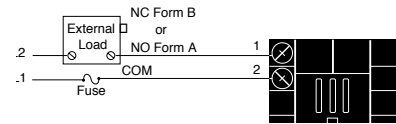

Form A or B alarm jumper settings (98_C-___-J___ only)

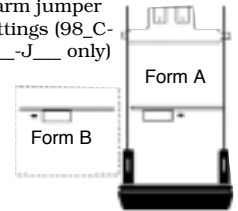

Figure 2.13b — Switched DC

98 _ C - _ _ _ _ - **C** _ _ _ _

Minimum load resistance: 500Ω

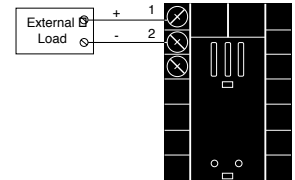
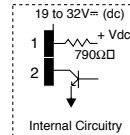

Figure 2.13c — Process Retransmit

0-20mA, 4-20mA, Load impedance: 600Ω max.

98 _ C - _ _ _ _ - **M** _ _ _ _

0-5V_{rms}, 1-5V_{rms}, 0-10V_{rms} (dc), Load impedance: 500Ω min.

98 _ C - _ _ _ _ - **N** _ _ _ _

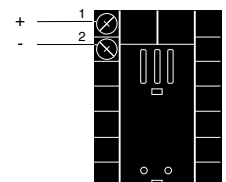

NOTE:
Input-to-output isolation is defeated when the external signal conditioner power supply is used to power a transmitter connected to input 1.

Figure 2.13d — External Signal Conditioner Power Supply

98 _ C - _ _ _ _ - **T** _ _ _ _

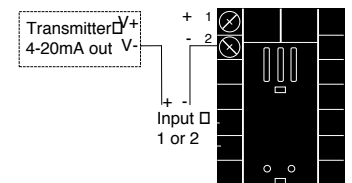

NOTE:
See Chapter 1 for DIP switch location and settings.

Output 4 Wiring

Figure 2.14a — AC Outputs

NOTE:
Successful installation requires five steps:

- Model number and software choice (Appendix);
- DIP switch settings (Chapter 1);
- Sensor match (Chapter 2 and Appendix);
- Sensor installation (Chapter 2); and
- Wiring (Chapter 2).

Solid-state Relay with Contact Suppression

98 _ C - _ _ _ _ - _ B _ _

0.5 amps, minimum off-state impedance: 20KΩ

Electromechanical Relay with Contact Suppression

(NO and COM contacts only)

98 _ C - _ _ _ _ - _ D _ _ _

Form C, 5 amps, minimum off-state impedance: 20KΩ

Electromechanical Relay without Contact Suppression

98 _ C - _ _ _ _ - _ E _ _ _

Form C, 5 amps, off-state impedance: 31MΩ

Solid-state Relay without Contact Suppression

98 _ C - _ _ _ _ - _ K _ _ _

0.5 amps, off-state impedance: 31MΩ

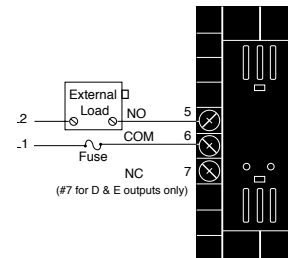

Figure 2.14b — Switched DC, Open Collector

98 _ C - _ _ _ _ - _ C _ _

Minimum load resistance: 500Ω

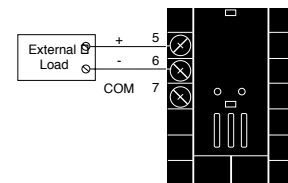
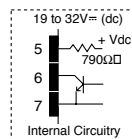
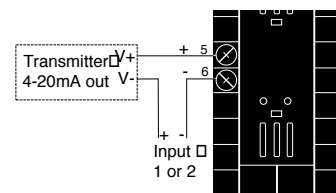

Figure 2.14c — External Signal Conditioner Power Supply

98 _ C - _ _ _ _ - _ T _ _

NOTE:
Input-to-output isolation is defeated when the external transmitter power supply is used to power a signal conditioner connected to input 1.

NOTE:
See Chapter 1 for power supply DIP switch information.



For data communications wiring refer to *Data Communications with the Watlow Series 988 Family of Controllers.*

Chapter 3 Front Panel and Display Loop

After 1 minute with no key activations, the control reverts to the Display Loop. The process value appears in the upper display and the set point is in the lower display. For more information on the Display Loop, see the next page.

Upper Display

Indicates either actual process value, the operating prompt values, or error codes. When powering up, the Process display will be blank for 3 seconds. Red or green, 0.4" (10mm) high, seven segment, four digit LED display.

Dev LED

When lit, the deviation from the current set point is shown in the lower display.

% Out LED

When lit, the current percent output is shown in the lower display.

Up Key

Increases the value of the displayed prompt. A light touch increases the value by one. Holding the key down increases the value at a rapid rate. New data is self entering in 5 seconds or once the Mode key or Display key is pressed.

Down Key

Decreases the value of the displayed prompt. A light touch decreases the value by one. Holding the key down decreases the displayed value at a rapid rate. New data is self entering in 5 seconds or once the Mode key or Display key is pressed.

Up + Down Keys

When pressed simultaneously for 3 seconds, the Setup (SEt) prompt appears. Continue to press the Up/Down keys for another 3 seconds and the Factory (Fcty) prompt appears.

Figure 3.1 - Series 982 Keys and Displays.

Lower Display

Indicates the set point, deviation, percent power temperature unit, menu prompts, or alarm codes. Red or green, 0.3" (8mm) high, seven segment, four digit LED display.

L1, L2, L3, L4

When lit, these LEDs indicate when Output 1, 2, 3, or 4 are active respectively. Outputs can be configured as:

- Ot1 Control
- Ot2 Control or Alarm
- Ot3 Alarm, Event or Retransmit
- Ot4 Alarm, Event or Communications (flashes on transmit and receive.)

Display Key

Pressing this key enters the Display Loop. The Display key can be pressed at any time to return to this loop. For more information on the Display Loop, see the next page.

Hold/Run Key

Pressed once, it clears a latched alarm without altering the Hold/Run status. To run or halt a program see Chapter 7 for details.

Hold/Run LED

Lit when the program is running. When blinking, press the Hold/Run key again to begin running. When not lit, the controller is in fixed set point mode or single.

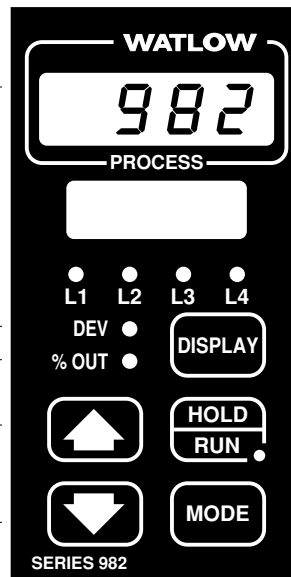

Mode Key

Steps the control through the menus. New data is entered once the Mode key is pressed.

Mode + Up Key

To move backwards through the menus, hold down the Mode key, then press the Up key to scroll. The Mode key must be pressed first and held before the Up key will begin scrolling. Scrolling is disabled once the keys are released or you reach the top of the menu.

Display Loop

NOTE:

For information on Input 1 **in1** and Input 2 **in2** ranges, refer to Chapter 4.

NOTE:

If **no** is selected for **in2**, in the Input Menu, the **Pr 2** prompt will not appear.

Figure 3.2 - The Display Loop.

Display Loop

The Display Loop is the “home” state of the Series 982 controller. Pressing the Display key **DISPLAY** returns the controller to the Display Loop from any prompt in any menu. The controller automatically returns to the Display Loop from any menu when a minute passes without any keys being pressed.

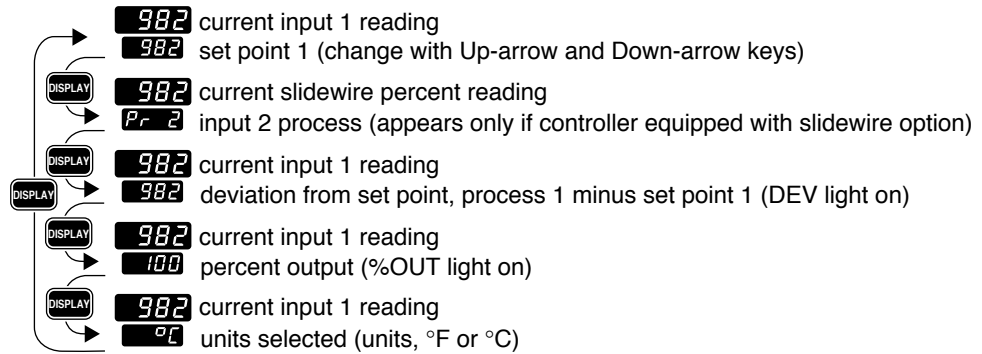

Single Set Point

When a program is not running, you can adjust the set point, shown in the lower display, by pressing the Up-arrow or Down-arrow key or through serial communications. You can de-energize all outputs, including event outputs, by lowering set point 1 to the range low setting minus one, which will display **OFF** in the lower display.

Ramping

When a program is running, the set point is controlled by the program. You can view this set point, but cannot change it while the program is running. You can select the event output status for each step.

Chapter 4 The Setup Menus

Navigating the Setup Menu



CAUTION:
When navigating thru Setup Menus, outputs will be disabled.

NOTE:
Press the Display key **DISPLAY** to return to the Display Loop from any point in any menu.

To reach the Setup Menu, begin in the Display Loop and press both the Up-arrow **▲** and Down-arrow **▼** keys for three seconds. The Setup Menu prompt **SEt** will appear in the lower display, and the Input Menu prompt **InPt** will appear in the upper display. The four Setup Menus are: Input **InPt**; Output **OutPt**; Global **GLbL**; and Communications **COmM**. Use the Up-arrow **▲** or Down-arrow **▼** key to select a menu and the Mode key **MODE** to step through a menu. The Communications Menu appears only on units equipped with the data communications option.

You will not see every prompt in any of these menus. The unit's configuration and model number determine which prompts appear. After stepping through each menu, the Series 982 returns to the Setup Menu prompt **SEt**. Use the Up-arrow **▲** and Down-arrow **▼** keys to select the next menu, or use the Mode key **MODE** to advance through the same menu again. To move backwards through the menu hold the Mode key **MODE** down and press the Up-arrow key **▲**. Use the Up-arrow **▲** or Down-arrow **▼** key to change the prompt setting.

Refer to the Appendix for model number options. For information about communications and the communications prompts, refer to the supplemental manual *Data Communications with the Watlow Series 988 Family of Controllers*.



① Begin in the Display Loop, and press the Up-arrow **▲** and Down-arrow **▼** keys simultaneously to reach the Setup Menu.

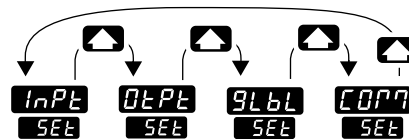

Input Menu p. 4.2
Output Menu p. 4.12
Global Menu p. 4.28
Communications Menu p. 4.38

Figure 4.1 - Navigating the Setup Menus.

NOTE:
The lockout DIP switch hides the Setup Menu. See Chapter 1.



② Press the Up-arrow key **▲** to select one of the Setup Menus.

Setup-Input

Reaching the Input Menu

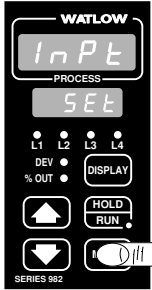

③ Select the Input Menu, then press the Mode key **MODE** to step through the prompts.

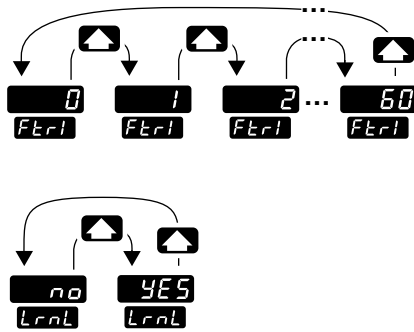

④ Press the Up-arrow key or the Down-arrow key to select one of the prompt values.

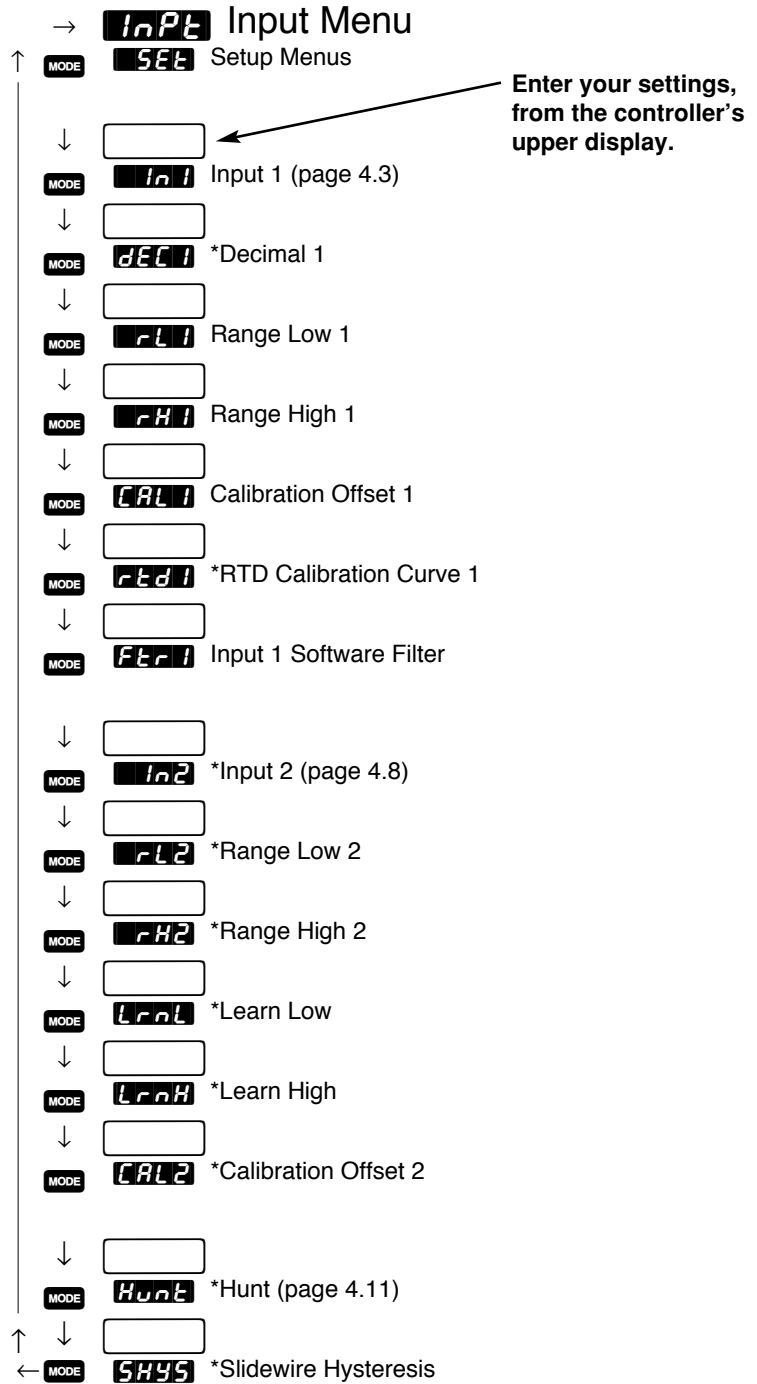

Figure 4.2 - The Input Menu.

*Prompts may not appear, depending on controller configuration.

Input Prompts

NOTE:
 Decimal points may not always be in the position specified below depending on the the settings in the Decimal 1 **DEC1** parameter in the Input Menu.



CAUTION:
 Changing the value of **In 1** changes most other prompts to the factory default values and clears all program steps. Verify the correct sensor type before making a change. Document all settings before changing sensor type. Failure to follow this guideline could result in damage to equipment or property.

In 1
Input 1 continued on next page.

When you are in the Setup menus, the Series 982 displays the menu selection (**InPt**, **DEPt**, **9L6L** or **COPT**) in the upper display, and **SEt** in the lower display.

The Up-arrow or Down-arrow key selects another menu. Press the Mode key **MODE** to display the prompt in the lower display and its value in the upper display. Use the Up-arrow or Down-arrow key to change the value in the upper display. The new value will not take effect until after a five-second delay or until you press the Mode key **MODE**.

Input 1

Select sensor type for input 1. This selection must match the sensor type connected to terminals 8, 9 and 10. See Appendix for more information about sensors.

- Changing the value of **In 1** changes all other prompts to the factory default values, except the Communications and Lockout menus, the **CLF** prompt in the Global Menu and the **dFL** prompt in the Calibration Menu. If you change the value, the default warning **dFLt** will flash in the upper display.
- Changes do not take effect automatically after five seconds; you must press the Mode key **MODE** to enter the sensor type change and advance to the next prompt.

In 1 This prompt always appears.

	If	Default									
98	-1	-									
	no DIP		J	K	T	N	E	W5	W3	Pt2	
			J	H	t	n	E	C	d	Pt2	
	thermocouple only		In 1	In 1	In 1	In 1	In 1	In 1	In 1	In 1	
98	-2	-									
	Input 1 DIP		J	K	T	N	E	W5	W3	Pt2	
			J	H	t	n	E	C	d	Pt2	
	thermocouple		In 1	In 1	In 1	In 1	In 1	In 1	In 1	In 1	
	Input 1 DIP		R	S	B						
			r	S	b						
	thermocouple		In 1	In 1	In 1						

Setup-Input

ln 1

Input 1 continued
from previous
page.

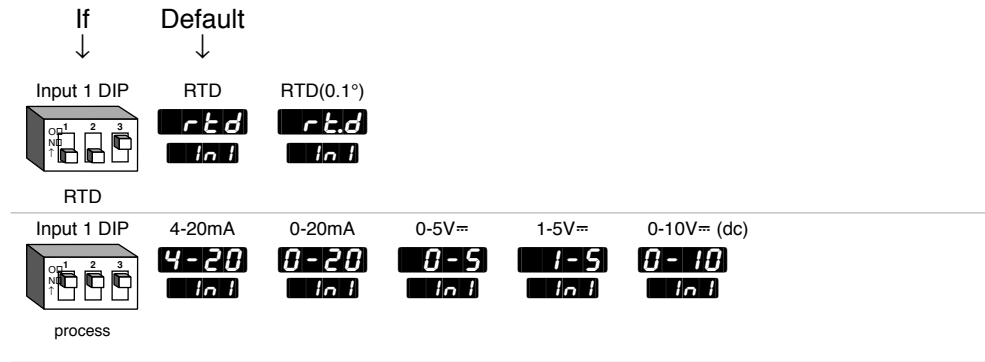

dec 1

Decimal 1

Select the decimal point location for process type input 1 data. This prompt, in conjunction with the Range Low and Range High prompts, allows you to format and limit units of measure for process 1.

- All prompts with units of measure related to input 1 will display in the selected decimal format.
- This affects propbands, alarm set points, process set points, calibration offsets, deadbands and ranges.

dec 1 This prompt appears only if you have set input 1 **ln 1** to a process input.



rL1

rH1

Range Low 1 and Range High 1

Select the low and high limits for input 1. These prompts limit the adjustment range for the set points. The default values are the same as the limits of the sensor you selected by setting the input 1 DIP switch and selecting a value for Input 1 **in1**.

- Process inputs are scaled by these values. Range high is the value displayed when the maximum process signal is present at the input. Range low is the value displayed when the minimum process signal is present at the input.

NOTE:
These values do not affect the low or the high set point limit for process alarms.

Example: Set **in1** to **4-20** mA.
Set **rL1** to **100**.
Set **rH1** to **500**.
A 4mA input will display **100**.
A 12mA input will display **300**.
A 20mA input will display **500**.

- The low and high values of each sensor type are listed on the specifications page of the Appendix.
- Choose between Fahrenheit and Celsius at the **C-F** prompt in the Global Menu.

rL1 rH1 These prompts always appear.

	Default	Default	Default	Default
	↓	↓	↓	↓
	°F	°C		
rL1	32	1500	0	816
rH1	1500	1500	816	816
				98 -1 - or 98 -2 -
(K)				
H	-328	2500	-200	1371
t	-328	750	-200	399
n	32	2372	0	1300
E	-328	1470	-200	799
(W5)				
C	32	4200	0	2316
(W3)				
d	32	4200	0	2316
Pt2	32	2543	0	1395

rL1
rH1

Range Low 1 and Range High 1 continued on next page.

Setup-Input

RL1
RH1

Range Low 1 and
Range High 1
continued from
previous page.

NOTE:
These values do not
affect the low or the
high set point limit
for process alarms.

	°F		°C		
	rl1	rh1	rl1	rh1	
r	32	3200	0	1760	98_-2_- only
in1					
s	32	3200	0	1760	
b	32	3300	0	1816	
rt.d	-328	1472	-200	800	
rt.d	-999	9999	-733	5377	
4-20		-999...999		units	
0-20		-999...999		units	
0-5		-999...999		units	
1-5		-999...999		units	
0-10		-999...999		units	

Calibration Offset 1

Offset the input 1 signal by a positive or negative value. This allows you to compensate for lead resistance, sensor errors or other factors.

CAL1 This prompt always appears.

CAL1

If	Default
<p>↓</p> <p>°F</p> <p>C.F</p> <p>(Global Menu)</p>	<p>↓</p> <p>-999 ... 0 ... 999</p> <p>CAL1 CAL1 CAL1</p>
<p>°F & rt.d</p> <p>C.F in1</p> <p>(Global Menu) (Input Menu)</p>	<p>-999 ... 0.0 ... 999</p> <p>CAL1 CAL1 CAL1</p>
<p>°C</p> <p>C.F</p> <p>(Global Menu)</p>	<p>-555 ... 0 ... 555</p> <p>CAL1 CAL1 CAL1</p>
<p>°C & rt.d</p> <p>C.F in1</p> <p>(Global Menu) (Input Menu)</p>	<p>-555 ... 0.0 ... 555</p> <p>CAL1 CAL1 CAL1</p>
<p>a process input is selected</p>	<p>-999 ... 0 ... 999 units</p> <p>CAL1 CAL1 CAL1</p>

rtdd1

RTD Calibration Curve 1

Select the calibration curve for the RTD 1 input. The RTD input uses either the European (DIN, 0.003850Ω/Ω/°C) or the Japanese (JIS, 0.003916Ω/Ω/°C) linearization standard.

rtdd1 This prompt appears only if you have set in1 to rtd or rtd.

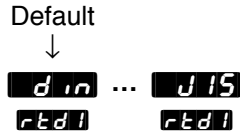

Ftr1

Software Filter 1

Select the filter time constant, in seconds, for input 1. This smooths a rapidly changing input signal for display or control purposes.

- Select a positive value to filter only the display.
- Select a negative value to filter the input signal.
- Set the value to 0 to disable the filter.

Ftr1 This prompt always appears.

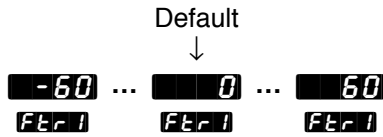

Setup-Input



CAUTION:

Changing the value of **In2** changes most other prompts to the factory default values and clears all program steps. Verify the correct sensor type before making a change. Document all settings before changing input type. Failure to follow this guideline could result in damage to equipment or property.

NOTE:

If **no** is selected for **In2** none of the other input 2 prompts will appear.

NOTE:

See Chapter 9 for more information on slidewire feedback.

Input 2

Select sensor type for input 2. This selection must match the sensor type connected to terminals 18, 19 and 20. See Appendix for more information about sensors.

- Changing the value of **In2** changes all other prompts to the factory default values, except the Communications and Lockout menus, the **CF** prompt in the Global Menu and the **dFLt** prompt in the Calibration Menu. If you change the value, the default warning **dFLt** will flash in the upper display.
- Changes do not take effect automatically after five seconds; you must press the Mode key **MODE** to enter the sensor type change and advance to the next prompt.

In2 This prompt and other Input 2 prompts appear only on controllers equipped with input 2 hardware (not 98__-0__-__).

	If ↓		Default ↓
98__-3__-__		no DIP	slidewire
		no	SL id
		resistance only	In2 In2
<hr/>			
98__-5__-__		no DIP	event 2
		no	E i2
		digital event only	In2 In2



NOTE:

These values do not affect the low or the high set point limit for process alarms.

NOTE:

If **SL id** is selected for **In2**, **0L2** prompt will not appear.

Range Low 2

Select the low resistance of the slidewire potentiometer.

rL2 This prompt appears only on controllers with **In2** (Input Menu) set to **SL id**.

Default ↓
0 ... rH2
rL2 rL2

rH2

NOTE:

These values do not affect the low or the high set point limit for process alarms.

NOTE:

See Chapter 9 for more information on slidewire feedback.

Range High 2

Select the high resistance of the slidewire potentiometer.

rH2 This prompt appears only on controllers with **ln2** (Input Menu) set to **SLid**.

Default
↓

rL2	...	0	...	1200
rH2		rH2		rH2

Lrnl

Learn Low

Write the low-end resistance of the slidewire potentiometer to the range low 2 parameter.

Lrnl This prompt appears only on controllers with **ln2** (Input Menu) set to **SLid**.

Default
↓

no	...	YES
Lrnl		Lrnl

LrnH

Learn High

Write the high-end resistance of the slidewire potentiometer to the range low 2 parameter.

LrnH This prompt appears only on controllers with **ln2** (Input Menu) set to **SLid**.

Default
↓

no	...	YES
LrnH		LrnH

CAL2

Calibration Offset 2

Offset the input 2 signal by a positive or negative value. This allows you to compensate for lead resistance, sensor errors or other factors.

CAL2 This prompt appears only on controllers with **In2** (Input Menu) set to **SLid**.

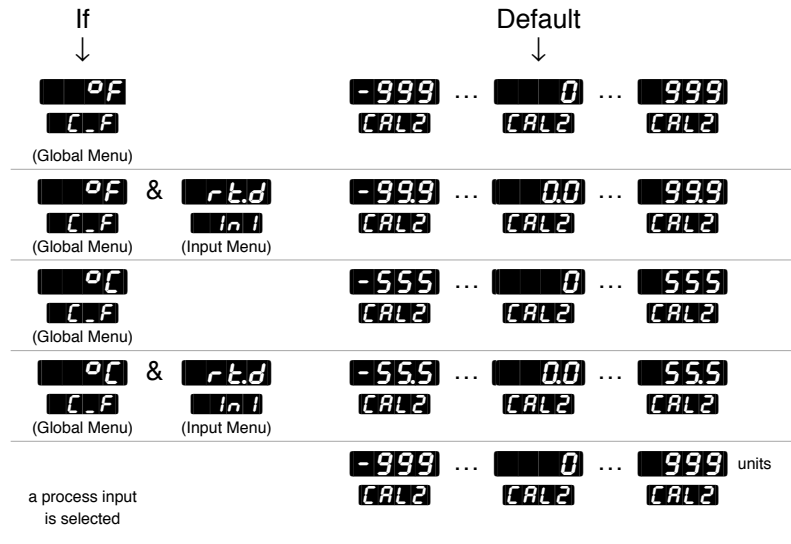

Hunt

Hunt

Set the deadband, as a percentage of output, to keep the valve from hunting.

- The slidewire hysteresis **SHYS** setting provides additional control over a valve.

Hunt This prompt appears only on controllers with **In2** (Input Menu) set to **SLid**.

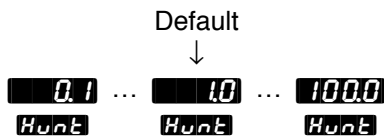

NOTE:
See Chapter 9 for more information on slidewire feedback.

SHYS

Slidewire Hysteresis

Set the inner hysteresis, the point at which the valve output turns off.

- The figure below illustrates the interaction between slidewire hysteresis **SHYS** and hunt **Hunt**.

SHYS This prompt appears only on controllers with **In2** (Input Menu) set to **SLid**.

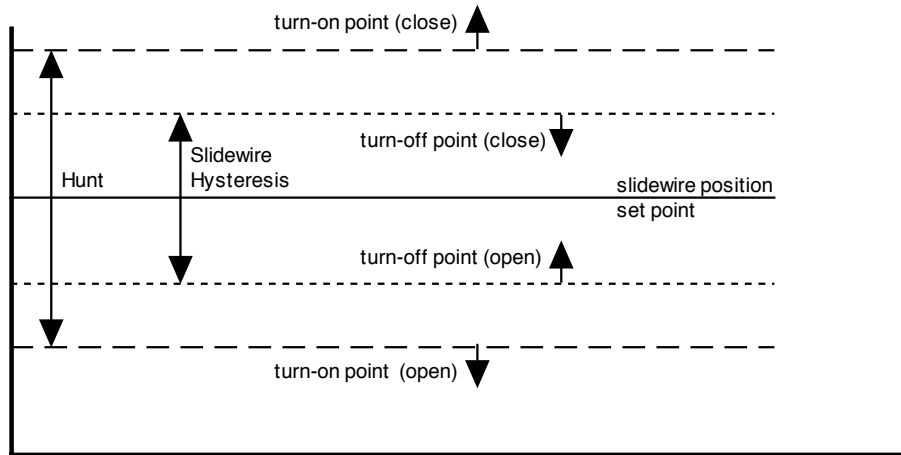
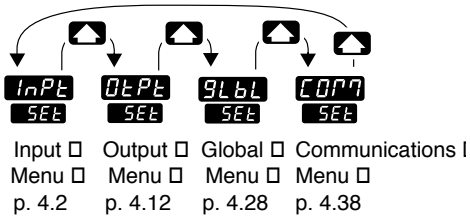

Figure 4.11 - Hunt and slidewire inner hysteresis.

Setup-Output

Reaching the Output Menu

1 Begin in the Display Loop, and press the Up-arrow and Down-arrow keys simultaneously for three seconds to reach the Setup Menus.



2 Press the Up-arrow key to select one of the Setup Menus.

3 Press the Mode key **MODE** to step through the prompts.

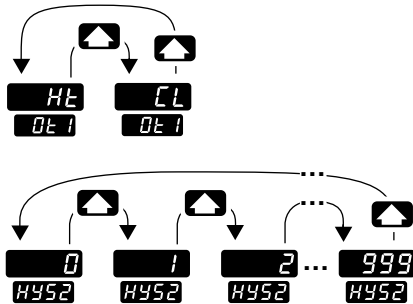

4 Press the Up-arrow key or the Down-arrow key to select one of the prompt values.

Figure 4.12 - Navigating the Output Menu.

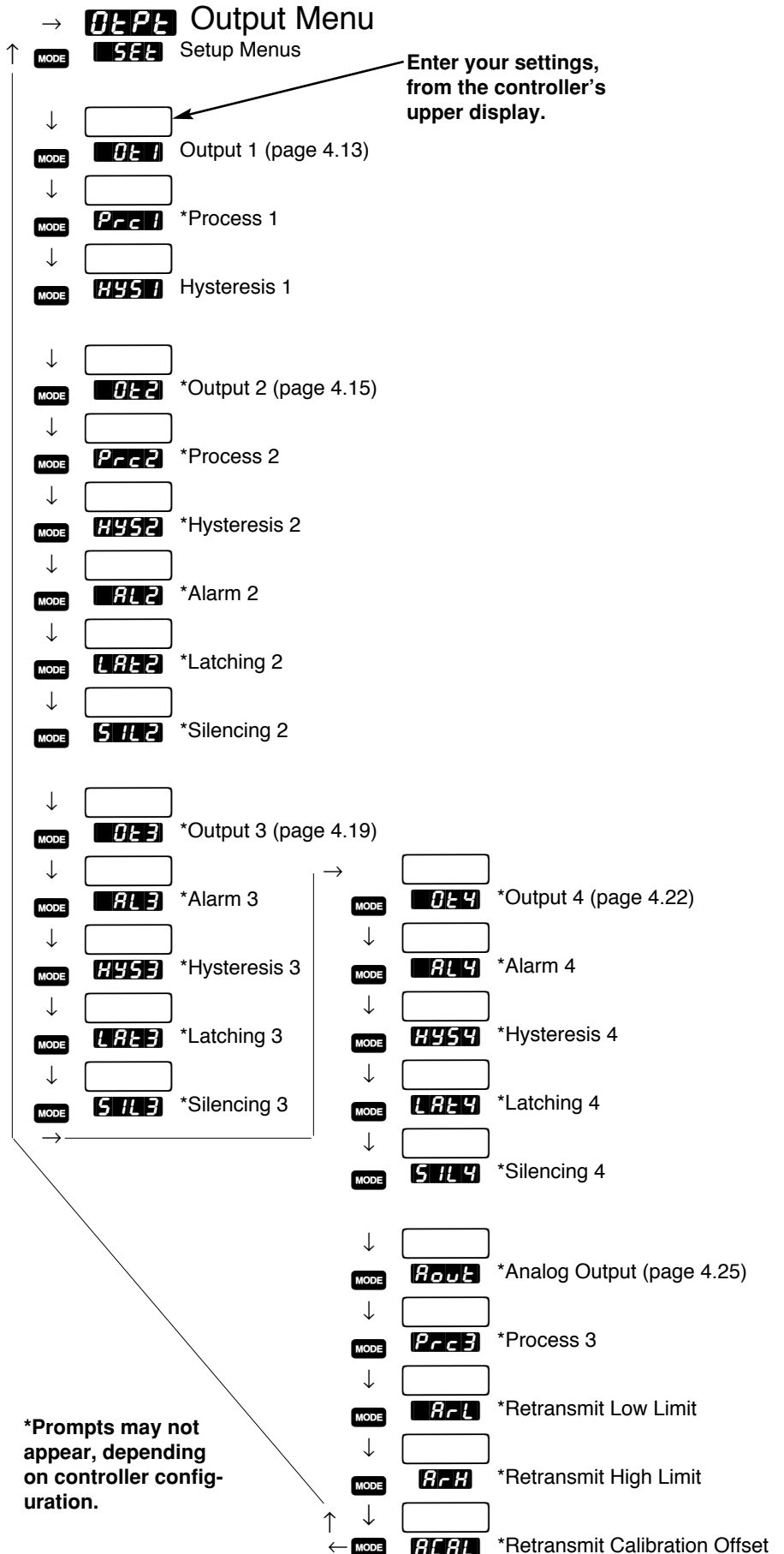

*Prompts may not appear, depending on controller configuration.

Output Prompts

NOTE:

Decimal points may not always be in the position specified below depending on the the settings in the Decimal 1 **DEC1** parameters in the Input Menu.

When you are in the Setup menus, the Series 982 displays the menu selection (**INPt**, **0tPt**, **9LbL** or **COPT**) in the upper display, and **SEt** in the lower display.

The Up-arrow or Down-arrow key selects another menu. Press the Mode key **MODE** to display the first prompt in the lower display and its value in the upper display. Use the Up-arrow and Down-arrow keys to change the value in the upper display. The new value will not take effect until after a five-second delay or until you press the Mode key **MODE**.

Output 1

Set the way that output 1 will respond to a difference between the set point and an input variable.

- **HL** select reverse action, so that output 1 responds when the input signal is less than the set point.
- **LL** select direct action, so that output 1 responds when the input signal is more than the set point.

0E1 This prompt always appears.

Default



HL	LL
0E1	0E1

Setup-Output

Prcl

Process 1

Select the process range for output 1.

Prcl This prompt appears only on controllers equipped with output 1 process hardware (98__F_).

Default



4-20mA	0-20mA	0-5V _{DC}	1-5V _{DC}	0-10V _{DC}
4-20	0-20	0-5	1-5	0-10
Prcl	Prcl	Prcl	Prcl	Prcl

Hys1

Hysteresis 1

Select the switching hysteresis for output 1. This determines the change in temperature or process units needed to turn the output from full on to full off.

Hys1 This prompt does not appear on controllers equipped with output 1 process hardware (98__F_).

If	Default
<p>↓</p> <p>OF</p> <p>C_F</p> <p>(Global Menu)</p>	<p>↓</p> <p>1 ... 3 ... 999</p> <p>Hys1 Hys1 Hys1</p>
<p>OF & rtd</p> <p>C_F In1</p> <p>(Global Menu) (Input Menu)</p>	<p>0.1 ... 3.0 ... 999</p> <p>Hys1 Hys1 Hys1</p>
<p>OC</p> <p>C_F</p> <p>(Global Menu)</p>	<p>1 ... 2 ... 555</p> <p>Hys1 Hys1 Hys1</p>
<p>OC & rtd</p> <p>C_F In1</p> <p>(Global Menu) (Input Menu)</p>	<p>0.1 ... 2.0 ... 555</p> <p>Hys1 Hys1 Hys1</p>
<p>a process input is selected</p>	<p>1 ... 3 ... 999 units</p> <p>Hys1 Hys1 Hys1</p>

0t2

Output 2

Set the way that output 2 will respond to a difference between the set point and an input variable.

NOTE:

0t2 prompt will not appear if **SLtd** is selected for **ln2**.

- **AL2** de-energizes output 2 in an alarm condition.
- **AL2n** energizes output 2 in an alarm condition.
- **Ht** select reverse action, so that output 2 responds when the input signal is less than the set point. This prompt only appears if **0t1** is set to **CL**.
- **CL** select direct action, so that output 2 responds when the input signal is more than the set point. This prompt only appears if **0t1** is set to **Ht**.

0t2 This prompt appears only on controllers equipped with output 2 hardware (not 98__-__A-__). **AL2** and **AL2n** do not appear if output 2 is a process output (98__-__F-__). **Ht** and **CL** do not appear if **AL90** (in the Global Menu) is set to **DUPL**.

Default



no **AL2** **AL2n** **Ht** or **CL**
0t2 **0t2** **0t2** **0t2** **0t2**

Pr2

Process 2

Select the process range for output 2.

Pr2 This prompt appears only on controllers equipped with output 2 process hardware (98__-__F-__) and with **0t2** not set to **no**.

Default



4-20mA 0-20mA 0-5V=
4-20 **0-20** **0-5** 1-5V=
Pr2 **Pr2** **Pr2** **Pr2** **Pr2** 0-10V=(dc)

H452

Hysteresis 2

Select the switching hysteresis for output 2. This determines the change in temperature or process units needed to turn the output from full off to full on.

- If **AL2** is set to **rALtE** settings for **H452** will be in degrees per minute or units per minute.
- If the input referenced by **AL2** is set to **rtd** the range is affected as listed below.

H452 This prompt appears only on controllers equipped with output 2 hardware and with **Out2** not set to **no**. This prompt does not appear on controllers with **In2** set to **SLid** or on controllers equipped with output 2 process hardware.

If ↓	Default ↓
oF C_F (Global Menu)	1 ... 3 ... 999 H452 H452 H452
oF & rtd C_F In1 (Global Menu) (Input Menu)	0.1 ... 30 ... 999 H452 H452 H452
oC C_F (Global Menu)	1 ... 2 ... 555 H452 H452 H452
oC & rtd C_F In1 (Global Menu) (Input Menu)	0.1 ... 20 ... 555 H452 H452 H452
a process input is selected	1 ... 3 ... 999 units H452 H452 H452

AL2

Alarm 2

Select the alarm type for alarm 2. Select the trigger points for the alarm with the **ALLO** and **AHI** settings in the System Menu **555**.

- **Pr1** uses the process signal from input 1. Changing the set point does not change the alarm response.
- **dE1** uses a deviation from the input 1 signal. Changing the set point changes the alarm response.
- **rAte** uses the rate of change at input 1 in degrees per minute.

NOTE:
See Chapter 8 for more information on alarms.

AL2 This prompt appears only on controllers equipped with output 2 hardware (not 98__-__A-__), and with **DE2** set to **AL2** or **AL2n**.



LAL2

Latching 2

Select whether alarm 2 will be latching or non-latching. A latching alarm **LAL** must be turned off manually. A non-latching alarm **nLA** turns off when an alarm condition no longer exists.

LAL2 This prompt appears only on controllers equipped with output 2 hardware (not 98__-__A-__) and with **DE2** set to **AL2** or **AL2n**.

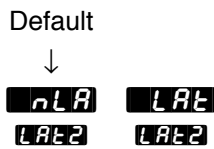

Setup-Output

SIL2

Silencing 2

Select silencing to inhibit alarm 2 on startup and to allow the operator to reset the alarm output, not the visual display.

- Silencing disables the alarm until the signal is between **R2L0** and **R2H1**.

NOTE:
See Chapter 8 for more information on alarms.

AL2 This prompt appears only on controllers equipped with output 2 hardware (not 98__-__A-__) and with **0E2** set to **AL2** or **AL2n**.

Default



OFF **0n**
SIL2 **SIL2**

0E3

Output 3

Set the way that output 3 will respond to a difference between the set point and an input variable.

- **AL3** de-energizes output 3 in an alarm condition.
- **AL3n** energizes output 3 in an alarm condition.
- **Ent3** sets output 3 to an event output.

NOTE:
See Chapter 8 for more information on alarms.

0E3 This prompt appears only on controllers equipped with output 3 hardware for a relay (98__-__-B__, 98__-__-J__ or 98__-__-K__) or switched dc (98__-__-C__).

Default



AL3 **AL3n** **Ent3** **no**
0E3 **0E3** **0E3** **0E3**

AL3

Alarm 3

Select the alarm type for alarm 3.

- **Pr1** uses the process signal from input 1.
- **dE1** uses a deviation from the input 1 signal.
- **rAtE** uses the rate of change at input 1 in degrees per minute.

AL3 This prompt appears only on controllers equipped with output 3 hardware for a relay (98__-__-B__, 98__-__-J__ or 98__-__-K__) or switched dc (98__-__-C__), and with **OL3** set to **AL3** or **AL3n**.

Default



Pr1	dE1	rAtE
AL3	AL3	AL3

H453

Hysteresis 3

Select the switching hysteresis for alarm 3. This determines the change in temperature or process units needed to turn the output from full off to full on.

- If **AL3** is set to **rALtE** settings for **H453** will be in degrees per minute or units per minute.
- If the input referenced by **AL3** is set to **rtd** the range is affected as listed below.

NOTE:
See Chapter 8 for more information on alarms.

H453 This prompt appears only on controllers equipped with output 3 hardware for a relay (98__-__-B__, 98__-__-J__ or 98__-__-K__) or switched dc (98__-__-C__) and with **0t3** set to **AL3** or **AL3n**.

If	Default
<p>↓</p> <p>oF C_F (Global Menu)</p>	<p>↓</p> <p>1 ... 3 ... 999 H453 H453 H453</p>
<p>oF & rtd C_F In1 (Global Menu) (Input Menu)</p>	<p>0.1 ... 30 ... 999 H453 H453 H453</p>
<p>oC C_F (Global Menu)</p>	<p>1 ... 2 ... 555 H453 H453 H453</p>
<p>oC & rtd C_F In1 (Global Menu) (Input Menu)</p>	<p>0.1 ... 20 ... 555 H453 H453 H453</p>
<p>a process input is selected</p>	<p>1 ... 3 ... 999 units H453 H453 H453</p>

LAL3

Latching 3

Select whether alarm 3 will be latching or non-latching. A latching alarm **LAL** must be turned off manually. A non-latching alarm **nLA** turns off when an alarm condition no longer exists.

LAL3 This prompt appears only on controllers equipped with output 3 hardware for a relay (98__-___-B__, 98__-___-J__ or 98__-___-K__) or switched dc (98__-___-C__) and with **OL3** set to **AL3** or **AL3n**.

NOTE:
See Chapter 8 for more information on alarms.

Default



nLA **LAL**
LAL3 **LAL3**

SIL3

Silencing 3

Select silencing to inhibit alarm 3 on startup and to allow the operator to reset the alarm output, not the visual display.

- Silencing disables the alarm until the signal is between **R3LO** and **R3HI**.

SIL3 This prompt appears only on controllers equipped with output 3 hardware for a relay (98__-___-B__, 98__-___-J__ or 98__-___-K__) or switched dc (98__-___-C__) and with **OL3** set to **AL3** or **AL3n**.

Default



OFF **On**
SIL3 **SIL3**

Setup-Output

0E4

Output 4

Set the way that output 4 will respond to a difference between the set point and an input variable.

NOTE:
See Chapter 8 for more information on alarms.

- **AL4** de-energizes output 4 in an alarm condition.
- **AL4n** energizes output 4 in an alarm condition.
- **Ent4** sets output 4 to an event output.

0E4 This prompt appears only on controllers equipped with output 4 hardware for a relay (98__-__-__-B__, 98__-__-__-D__, 98__-__-__-E__ or 98__-__-__-K__) or switched dc (98__-__-__-C__).

Default



AL4 **AL4n** **Ent4** **no**
0E4 **0E4** **0E4** **0E4**

AL4

Alarm 4

Select the alarm type for alarm 4.

- **Pr1** uses a process signal from input 1.
- **dE1** uses a deviation from the input 1 signal.
- **rAte** uses the rate of change at input 1 in degrees per minute.

AL4 This prompt appears only on controllers equipped with output 4 hardware for a relay (98__-__-__-B__, 98__-__-__-D__, 98__-__-__-E__ or 98__-__-__-K__) or switched DC (98__-__-__-C__) and **0E4** is set to

AL4 or **AL4n**.

Default



Pr1 **dE1** **rAte**
AL4 **AL4** **AL4**

H454

Hysteresis 4

Select the switching hysteresis for alarm 4. This determines the change in temperature or process units needed to turn the output from full off to full on .

- If **AL4** is set to **rALtE** settings for **H454** will be in degrees per minute or units per minute.
- If the input referenced by **AL4** is set to **rtd** the range is affected as listed below.

H454 This prompt appears only on controllers equipped with output 4 hardware for a relay (98__-__-_B_, 98__-__-_D_, 98__-__-_E_ or 98__-__-_K_) or switched dc (98__-__-_C_) and with **OL4** set to **AL4** or **AL4n**.

NOTE:
See Chapter 8 for more information on alarms.

If	Default
<p> PF CF (Global Menu) </p>	<p> 1 ... 3 ... 999 H454 H454 H454 </p>
<p> PF & rtd CF Input 1 or 2 (Global Menu) (see note above) </p>	<p> 0.1 ... 3 ... 999 H454 H454 H454 </p>
<p> OC CF (Global Menu) </p>	<p> 1 ... 2 ... 555 H454 H454 H454 </p>
<p> OC & rtd CF Input 1 or 2 (Global Menu) (see note above) </p>	<p> 0.1 ... 2 ... 555 H454 H454 H454 </p>
<p> a process input is selected </p>	<p> 1 ... 3 ... 999 units H454 H454 H454 </p>

Setup-Output

LAL4

Latching 4

Select whether alarm 4 will be latching or non-latching. A latching alarm **LAL** must be turned off manually. A non-latching alarm **nLA** turns off when an alarm condition no longer exists.

NOTE:
See Chapter 8 for more information on alarms.

LAL4 This prompt appears only on controllers equipped with output 4 hardware for a relay (98__-__-_B_, 98__-__-_J_ or 98__-__-_K_) or switched dc (98__-__-_C_) and with **OE4** set to **AL4** or **AL4n**.

Default



nLA **LAL**
LAL4 **LAL4**

SIL4

Silencing 4

Select silencing to inhibit alarm 4 on startup and to allow the operator to reset the alarm output, not the visual display.

- Silencing disables the alarm until the signal is between **A4LO** and **A4HI**.

SIL4 This prompt appears only on controllers equipped with output 4 hardware for a relay (98__-__-_B_, 98__-__-_D_, 98__-__-_E_ or 98__-__-_K_) or switched DC (98__-__-_C_) and with **OE4** set to **AL4** or **AL4n**.

Default



OFF **On**
SIL4 **SIL4**

Rout

Analog Output

Select which value to retransmit as the output 3 signal.

- **PrC1** retransmits the process 1 value.
- **SEPt** retransmits the set point.
- **PrC2** retransmits the process 2 value. This prompt appears only if the controller is equipped with input 2 hardware and if **In2** is not set to **no** or **Ein2**.
- **no** turns off retransmit function.

NOTE:
See Chapter 9 for more information on retransmit.

Rout This prompt appears only on controllers equipped with retransmit hardware (98__-__-M__ or 98__-__-N__).

Default



PrC1	SEPt	PrC2	no
Rout	Rout	Rout	Rout

PrC3

Process 3

Select the range for the retransmit signal at output 3.

PrC3 This prompt appears only on controllers equipped with retransmit hardware (98__-__-M__ or 98__-__-N__) and with **Rout** not set to **no**.

Default



4-20mA	0-20mA	0-5V=	1-5V=	0-10V= (dc)
4-20	0-20	0-5	1-5	0-10
PrC3	PrC3	PrC3	PrC3	PrC3

Setup-Output

ArL

Retransmit Low Limit

Select the low limit for the retransmit signal at output 3.

- The **default** value is equal to **rL1** or **rL2** (in the Input Menu) depending on whether **Rout** is set to **Prc1** or **Prc2**.

ArL This prompt appears only on controllers equipped with retransmit hardware (98__-__-M__ or 98__-__-N__) and with **Rout** not set to **no**.

-999 ... **ArH**
ArL **ArL**

NOTE:
See Chapter 9 for more information on retransmit.

ArH

Retransmit High Limit

Select the high limit for the retransmit signal at output 3.

- The **default** value is equal to **rH1** or **rH2** (in the Input Menu) depending on whether **Rout** is set to **Prc1** or **Prc2**.

ArH This prompt appears only on controllers equipped with retransmit hardware (98__-__-M__ or 98__-__-N__) and with **Rout** not set to **no**.

ArL ... **9999**
ArH **ArH**



Retransmit Calibration Offset

Select an offset value for the retransmit signal at output 3.

ACAL This prompt appears only on controllers equipped with retransmit hardware (98__-___-M__ or 98__-___-N__) and with **Route** not set to **no**.

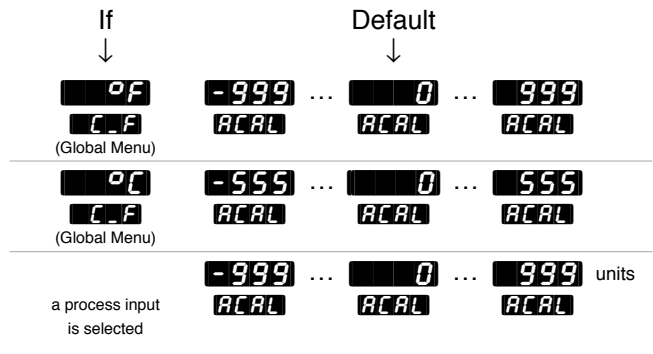

Setup-Global

Reaching the Global Menu

1 Begin in the Display Loop, and press the Up-arrow and Down-arrow keys simultaneously for three seconds to reach the Setup Menu.

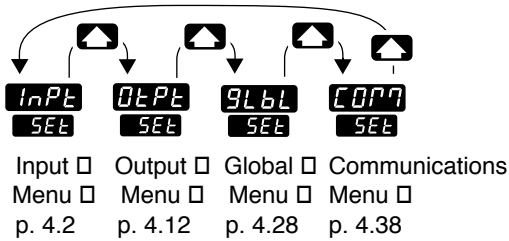

2 Press the Up-arrow key to select one of the Setup Menus.

3 Press the Mode key to step through the prompts.

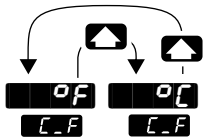

4 Press the Up-arrow key or the Down-arrow key to select one of the prompt values.

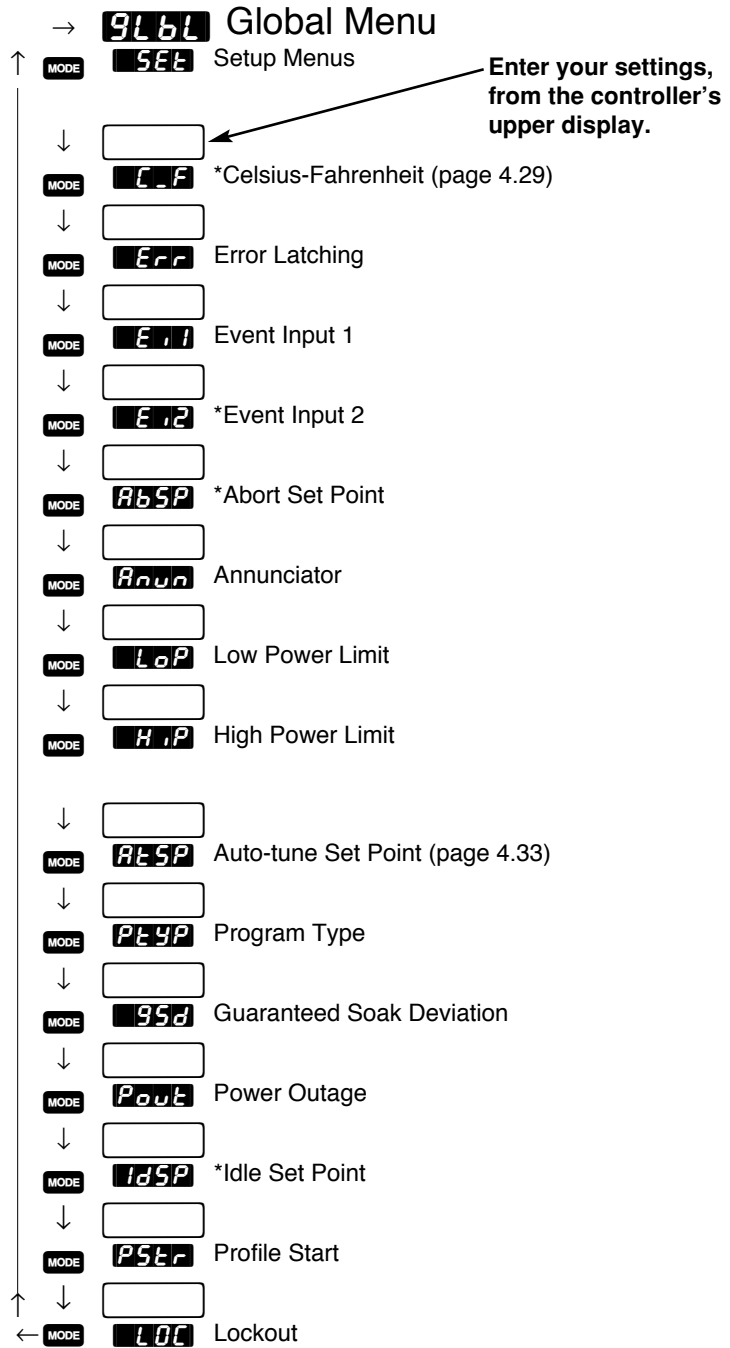

Figure 4.28 - Navigating the Global Menu.





*Prompts may not appear, depending on controller configuration.

Global Prompts

NOTE:

Decimal points may not always be in the position specified below depending on the the settings in the Decimal 1 **DEC1** parameters in the Input Menu.

When you are in the Setup menus, the Series 982 displays the menu selection (**INPT**, **DEPT**, **GLBL** or **COMP**) in the upper display, and **SET** in the lower display.

The Up-arrow  or Down-arrow key  selects another menu. Press the Mode key **MODE** to display the first prompt in the lower display and its value in the upper display. Use the Up-arrow  and Down-arrow  keys to change the value in the upper display. The new value will not take effect until after a five-second delay or until you press the Mode key **MODE**.



Celsius-Fahrenheit

Select which temperature scale the controller will use.

C_F This prompt appears only on controllers with **INI** set to something other than a process input.

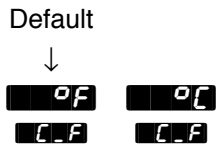

Error Latching

Select whether alarms will be latching or non-latching.

- Non-latching alarms **nLA** turn off when there is no alarm condition.
- Latching alarms **LAt** must be turned off manually.

Err This prompt always appears.

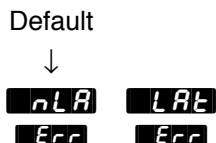

NOTE:

For more information on errors, see Chapter 8.

E . 1

Event Input 1

Select the effect of closing the event input 1 switch.

- **no** disables event input 1.
- **LOC** locks out the front panel keys.
- **ALr** resets an alarm.
- **OFF** turns all control outputs off (de-energize relays, but does not hold program).
- **hold** puts the controller into hold mode (ends the program and holds the last set point).
- **FIL1 FIL2 FIL3** or **FIL4** starts file 1, 2, 3 or 4.
- **AbSP** controls to the abort set point.
- **PAUS** pauses a running profile.
- **WJE** can be configured as a waitfor event input.

E . 1 This prompt always appears.

Default



no	LOC	ALr	OFF	hold	FIL1	...	FIL4	AbSP	PAUS	WJE
E . 1	E . 1	E . 1	E . 1	E . 1	E . 1		E . 1	E . 1	E . 1	E . 1

E 12

Event Input 2

Select the effect of closing the event input 2 switch.

- **no** disables event input 2.
- **LOC** locks out the front panel keys.
- **ALr** resets an alarm.
- **OFF** turns all control outputs off (de-energize relays, but does not hold program).
- **hold** puts the controller into hold mode (ends the program and holds the last set point).
- **FIL1 FIL2 FIL3** or **FIL4** starts file 1, 2, 3 or 4.
- **AbSP** controls to the abort set point.
- **PAUS** pauses a running profile.
- **WJE** can be configured as a waitfor event input.

E 12 This prompt appears only on controllers with event input 2 hardware (98__-5__-__) and with **In2** (Input Menu) set to **E 12**.

Default

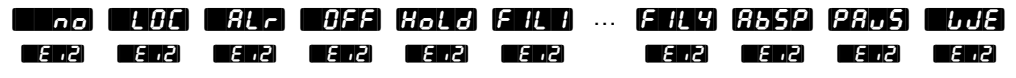

AbSP

Abort Set Point

Select the set point that will take effect when a running profile is aborted with an event input switch.

AbSP This prompt appears only on controllers with **E 11** or **E 12** set to **AbSP**.

Default

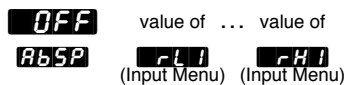

Setup-Global

Annun

Annunciator

Select whether alarm messages will flash in the lower display.

Annun This prompt always appears.

Default



On **OFF**
Annun **Annun**

LoP

Low Power Limit

Select the low limit for the percent output. For cooling (direct acting) enter a negative number.

LoP This prompt always appears.

If



a heat/cool
application

Default



-100%... **HIP**
LoP **LoP**

a heat only
application

0%... **HIP**
LoP **LoP**

a cool only
application

-100%... **HIP**
LoP **LoP**

H.P

High Power Limit

Select the high limit for the percent output. For cooling (direct acting) enter a negative number.

H.P This prompt always appears.

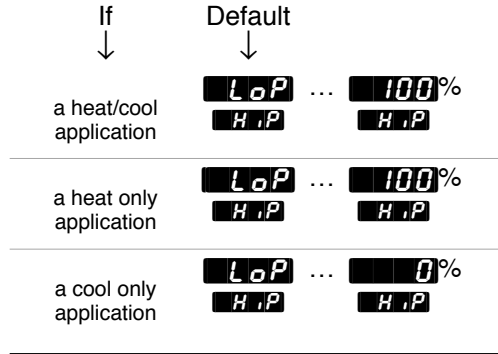

AtSP

Auto-tune Set Point

Select the percentage at which the controller will auto-tune the current control set point.

AtSP This prompt always appears.

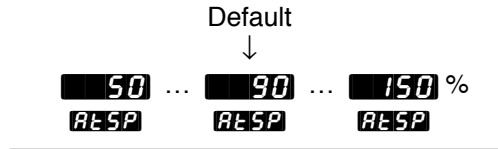

PLYP

Program Type

Select whether the program type will be time based or ramp rate.

- **TIME** selects a time based program.
- **RATE** selects a program type of ramp rate in degrees or units per minute.

PLYP This prompt always appears.

Default



TIME	RATE
PLYP	PLYP

95d

Guaranteed Soak Deviation

Guarantees that the process temperature or units is maintained within the selected window centered on the set point. If the process temperature or units varies above or below the set point by more than the selected value, the time clock stops and the lower display alternately flashes **95d** and the current parameter until the process variable is again within the window. Setting **95d** to **0** disables guaranteed soak deviation.

95d This prompt always appears.

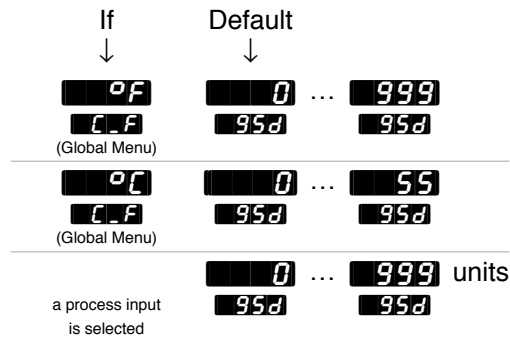

Pout**Power Outage**

Select what will happen when power is lost, then restored. Make sure the backup battery DIP switch is on (see Chapter 1).

- **Cont** continues running the profile from the point at which it was interrupted.
- **HOLD** maintains the set point in effect when the power was interrupted.
- **Abrt** quits running the profile, displays **OFF** in the lower display and turns off all outputs.
- **IdSP** maintains the set point selected at the idle set point prompt **IdSP** (the next prompt).
- **rSEt** resets the program to step 1.
- If **Hold**, **Abrt** or **IdSP** is selected, the lower display alternately flashed **Pout** and the current parameter. Press **HOLD RUN** to clear it.

Pout This prompt always appears.

Default



Cont	HOLD	Abrt	IdSP	rSEt
Pout	Pout	Pout	Pout	Pout

Setup-Global

IdSP

Idle Set Point

Select the set point that will take effect after a power interruption.

IdSP This prompt only appears if **Poub** is set to **IdSP**.

NOTE:
Decimal points may not always be in the position specified depending on the the settings in the Decimal 1 **DEC1** parameter in the Input Menu.

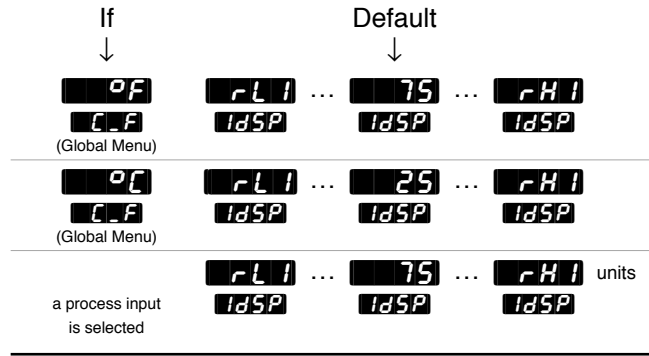

PStP

Profile Start

Select whether the profile starts at the current set point value **StPt** or the current process value **Proc**.

- If **Poub** is set to **Cont** and **PStP** is set to **Proc**, then if power is interrupted the controller will use the current process value as its set point.

PStP This prompt always appears.

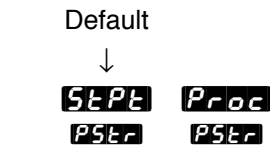



Lockout

Select the level of operator lockout.



- **0** no lockout.
- **1** locks out the PID and Calibration menus and the auto-tune prompt, **AUT**.
- **2** locks out the System, Program, PID and Calibration menus.
- **3** locks out the System, Program, PID and Calibration menus and locks the set point.

LOC This prompt always appears.

Default



Reaching the Communications Menu

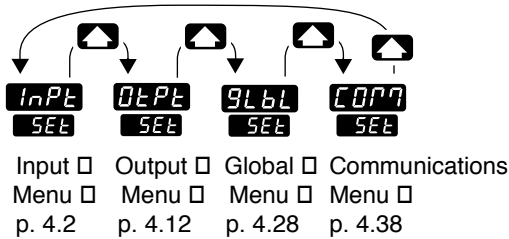

1 Begin in the Display Loop, and press the Up-arrow  and Down-arrow  keys simultaneously for three seconds to reach the Setup Menu.

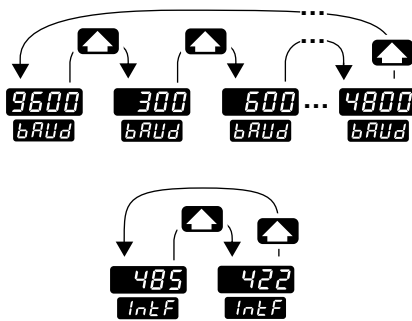

2 Press the Up-arrow key  to select one of the Setup Menus.

3 Press the Mode key  to step through the prompts.



4 Press the Up-arrow key  or the Down-arrow key  to select one of the prompt values.

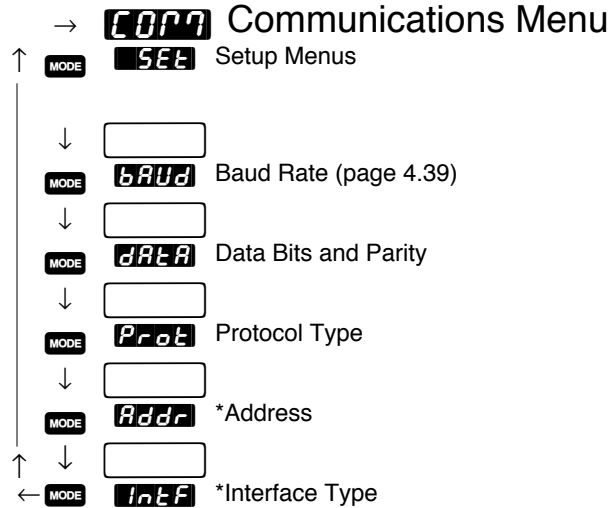

*Prompts may not appear, depending on controller configuration.





NOTE:
 The Communications Menu appears only on controllers equipped with communications hardware (98__-__-R__ or 98__-__-S__ or 98__-__-U__).

See *Data Communications with the Series 988 Family of Controllers* for detailed information on communications.

Figure 4.38 - Navigating the Communications Menu.

Communications Prompts

When you are in the Setup menus, the Series 982 displays the menu selection (**INPT**, **DEPT**, **GLBL** or **COPY**) in the upper display, and **SET** in the lower display.

The Up-arrow  or Down-arrow key  selects another menu. Press the Mode key **MODE** to display the first prompt in the lower display and its value in the upper display. Use the Up-arrow  and Down-arrow  keys to change the value in the upper display. The new value will not take effect until after a five-second delay or until you press the Mode key **MODE**.



Baud Rate

Select the communications speed.

BAUD This prompt appears only on controllers equipped with communications hardware (98__-__-__-R__ or 98__-__-__-S__ or 98__-__-__-U__).

Default



Data Bits and Parity

Select the communications format (start bit = 1, stop bit = 1).

- Setting **Prot** to **Mod** automatically sets **DATA** to **8n**.

DATA This prompt appears only on controllers equipped with communications hardware (98__-__-__-R__ or 98__-__-__-S__ or 98__-__-__-U__).

Default



Prot

Protocol Type

Select the communications protocol.

- **FULL** selects ANSI X3.28 2.2 - A.3.
- **On** selects Xon/Xoff.
- **Mod** selects Modbus.

Prot This prompt appears only on controllers equipped with communications hardware (98__-__-R__ or 98__-__-S__ or 98__-__-U__).

Default



FULL	On	Mod
Prot	Prot	Prot

Addr

Address

Select an address for the controller. The computer will use this address when communicating with this controller.

Addr This prompt appears only on controllers equipped with communications hardware for EIA/TIA-485 and EIA/TIA-422 (98__-__-S__).

If



485
IntF
422
IntF

Default



0 ... 31	
Addr	Addr
0 ... 9	
Addr	Addr

IntF

Interface Type

Select the interface type for Output 4, option S.

- **485** selects EIA/TIA-485.
- **422** selects EIA/TIA-422.

IntF This prompt appears only on controllers equipped with communications hardware for EIA/TIA-485 and EIA/TIA-422 (98__-__-_S_).



IntF

Interface Type

Select the interface type for Output 4, option U.

- **485** selects EIA/TIA-485.
- **232** selects EIA/TIA-232.

IntF This prompt appears only on controllers equipped with communications hardware for EIA/TIA-485 and EIA/TIA-232 (98__-__-_U_).



Notes

Chapter 5 The Operation Menus

Navigating the Operation Menus

To reach the Operation Menu, begin in the Display Loop and press the Mode key **MODE**. The Operation Menu prompt **OPER** will appear in the lower display. The three Operation Menus are: System **SYS**, PID **Pid** and Program **Prog**. Use the Up-arrow **▲** or Down-arrow **▼** key to select a menu and the Mode key **MODE** to step through a menu.

You will not see every prompt in any of these menus. The unit's configuration and model number determine which prompts appear. After stepping through each menu, the Series 982 returns to the Operation Menu prompt **OPER**. Use the Up-arrow **▲** and Down-arrow **▼** keys to select the next menu, or use the Mode key **MODE** to advance through the same menu again. To move backwards through the menu hold the Mode key **MODE** down and press the Up-arrow key **▲**. Use the Up-arrow **▲** or Down-arrow **▼** key to change the prompt setting.

NOTE:
Press the Display key **DISPLAY** to return to the Display Loop from any point in any menu.



1 Begin in the Display Loop, and press the Mode key **MODE** to reach the Operation menus **OPER**.

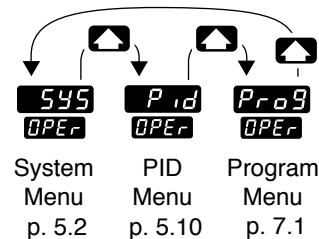

2 Press the Up-arrow **▲** key to select one of the Operation menus.

Figure 5.1 - Navigating the Operation Menus.

Operation-System

Reaching the System Menu



③ Select the System Menu, then press the Mode key **MODE** to step through the prompts.

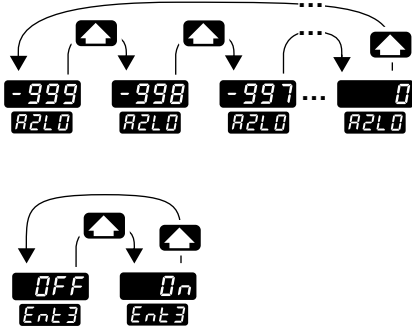

④ Press the Up-arrow key to step through the prompt values. The Down-arrow key backs through the values.

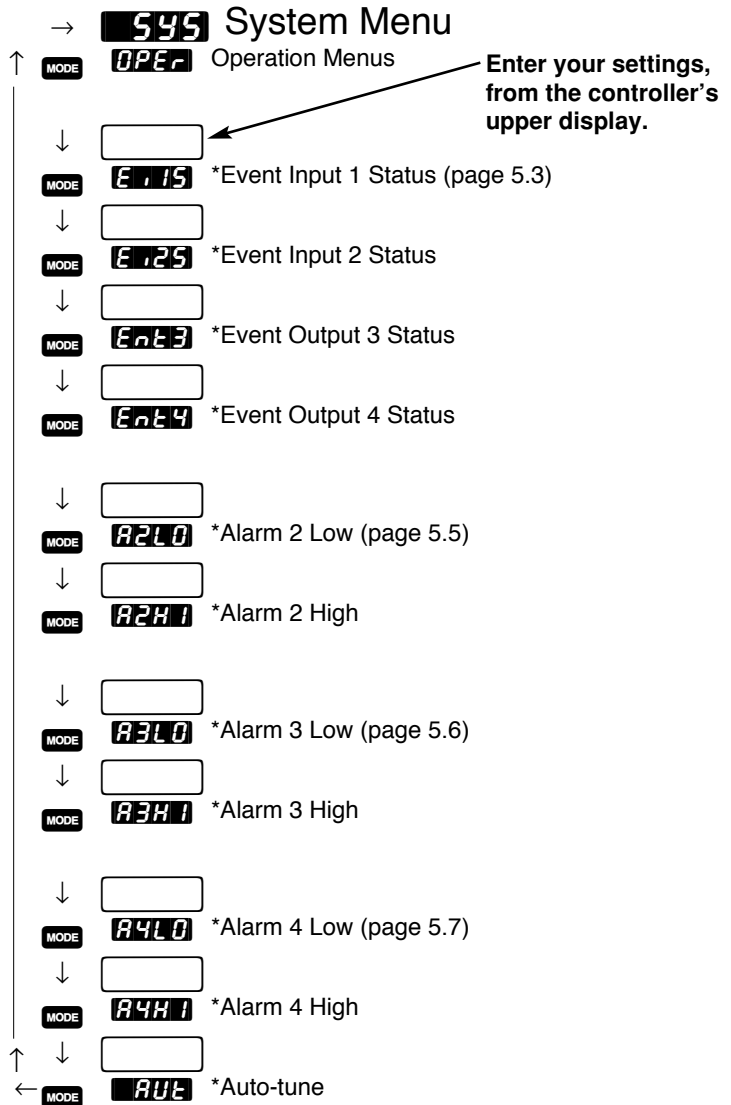

*Prompts may not appear, depending on controller configuration.





Figure 5.2 - The System Menu.

System Prompts

NOTE:

Decimal points may not always be in the position specified depending on the setting in the Decimal 1 **E11** parameter in the Input Menu.

When you are in the Operations menus the Series 982 displays the menu selection (**SYS**, **PID** or **PROG**) in the upper display and **OPEN** in the lower display.

The Up-arrow  or Down-arrow key  selects another menu. Press the Mode key **MODE** to display the first prompt in the lower display and its value in the upper display. Use the Up-arrow  and Down-arrow  keys to change the value in the upper display. The new value will not take effect until after a five-second delay or until you press the Mode key **MODE**.



Event Input 1 Status

Indicates whether the event input 1 circuit is open or closed. This is a read-only prompt.

E.15 This prompt appears only if **E.11** (Global Menu) is set to something other than **no**.

Default

↓
OPEN **CLOS**
E.15 **E.15**



Event Input 2 Status

Indicates whether the event input 2 circuit is open or closed. This is a read-only prompt.

E.25 This prompt appears only on controllers equipped with event input 2 hardware (98__-5__-__) and with **E.12** (Global Menu) set to something other than **no**.

Default

↓
OPEN **CLOS**
E.25 **E.25**

Ent3

Event Output 3 Status

Sets event output 3 on or off. When a profile is complete or on hold, it holds at its previous state.

Ent3 This prompt appears only when **0t3** (Output Menu) set to **Ent3**.

Default



OFF	On
Ent3	Ent3

Ent4

Event Output 4 Status

Sets event output 4 on or off. When a profile is complete or on hold, it holds at its previous state.

Ent4 This prompt appears only when **0t4** (Output Menu) set to **Ent4**.

Default



OFF	On
Ent3	Ent3

A2L0

Alarm 2 Low

Select the low trigger value for the output 2 alarm.

A2L0 This prompt appears only if **AL2** (Output Menu) is set to something other than **no**.

NOTE:
For more information about alarms, see Chapter 8.

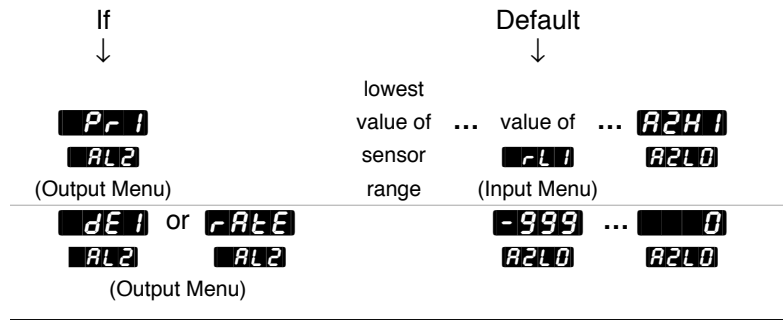

A2H1

Alarm 2 High

Select the high trigger value for the output 2 alarm.

A2H1 This prompt appears only if **AL2** (Output Menu) is set to something other than **no**.

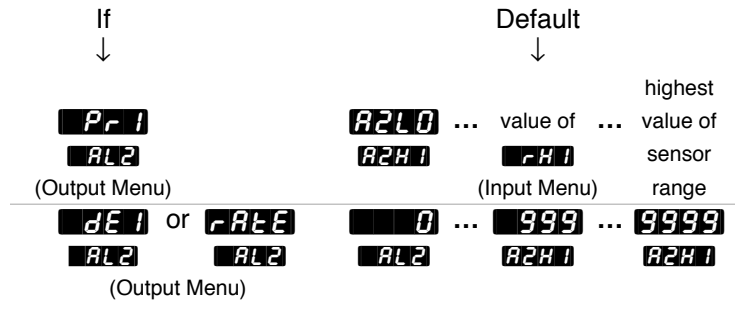

A3LO

Alarm 3 Low

Select the low trigger value for the output 3 alarm.

NOTE:

For more information about alarms, see Chapter 8.

A3LO This prompt appears only if **AL3** (Output Menu) is set to something other than **no**.

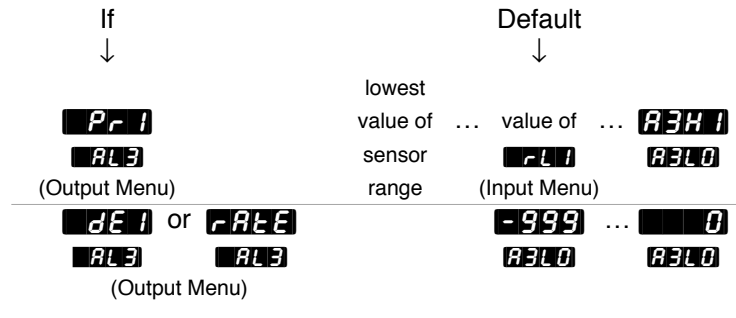

A3H1

Alarm 3 High

Select the high trigger value for the output 3 alarm.

A3H1 This prompt appears only if **AL3** (Output Menu) is set to something other than **no**.

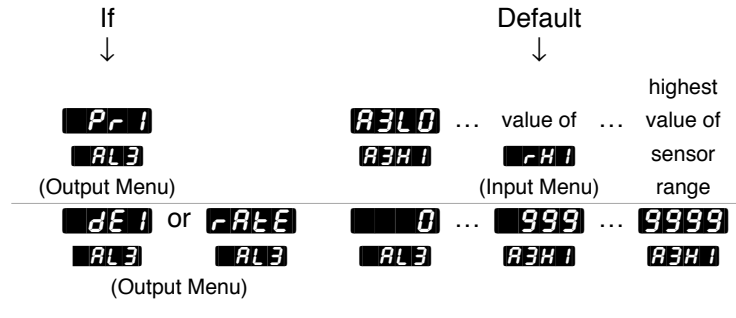

A4L0

Alarm 4 Low

Select the low trigger value for the output 4 alarm.

NOTE:
For more information about alarms, see Chapter 8.

A4L0 This prompt appears only if **AL4** (Output Menu) is set to something other than **no**.

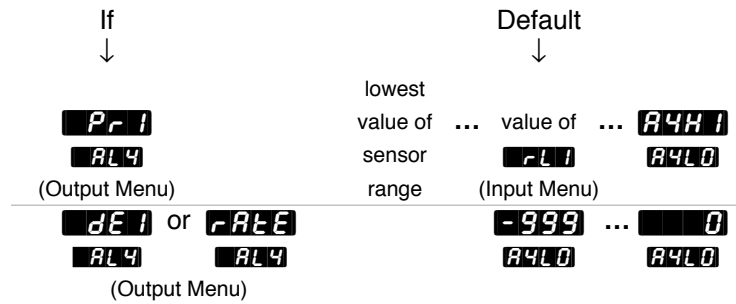

A4H1

Alarm 4 High

Select the high trigger value for the output 4 alarm.

A4H1 This prompt appears only if **AL4** (Output Menu) is set to something other than **no**.

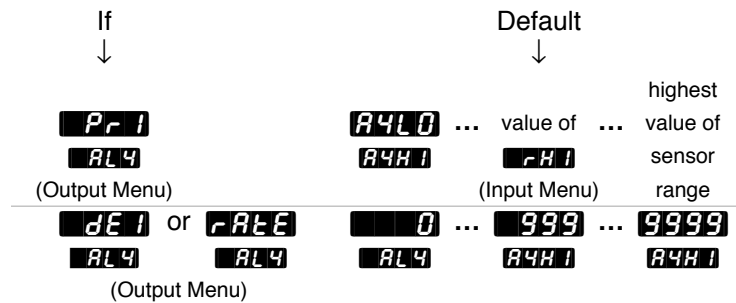

AUT

Auto-tune

Initiate an auto-tune.

NOTE:

For more information on auto-tune see Chapter 8.

AUT This prompt always appears.

Default



OFF	P id
AUT	AUT

Operation-PID

Reaching the PID Menus

1 Begin in the Display Loop, and press the Mode key **MODE** to reach the the Operation menus **OPER**.

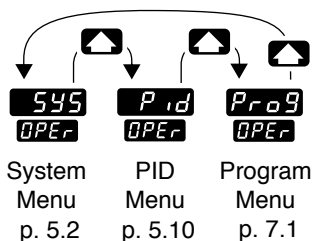

2 Use the Up-arrow **▲** key to select a menu.

3 Press the Mode key **MODE** to step through the prompts.

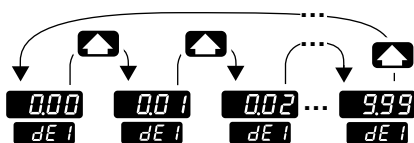

4 Press the Up-arrow key **▲** to step through the prompt values. The Down-arrow key **▼** backs through the values.

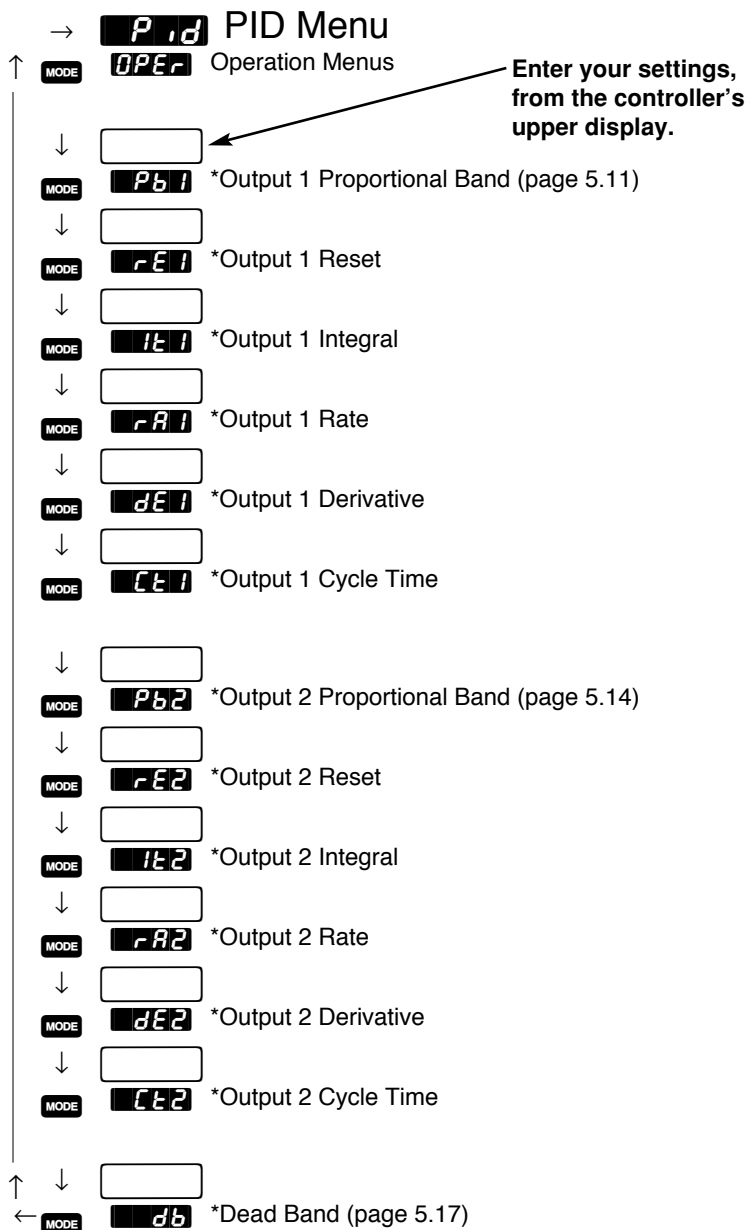

*Prompts may not appear, depending on controller configuration.





Figure 5.10 - The PID Menus.

PID Prompts

NOTE:

Decimal points may not always be in the position specified depending on the setting in the Decimal 1 **DEC1** parameter in the Input Menu.

When you reach the Operation menus, the Series 982 displays the menu selection (**545**, **P10** or **Pr09**) in the upper display and **OPER** in the lower display.

The Up-arrow  or Down-arrow key  selects another menu. Press the Mode key **MODE** to display the first prompt in the lower display and its value in the upper display. Use the Up-arrow  and Down-arrow  keys to change the value in the upper display. The new value will not take effect until after a five-second delay or until you press the Mode key **MODE**.



Output 1 Proportional Band

Select the proportional band for PID output 1. If set to **0** it functions as an on/off control, and the switching differential is determined by the **HYS1** value (Output Menu).

Pb1 This prompt always appears.

	If		Default	
	↓		↓	
	US	&	0	...
	DFL		25	...
(Calibration Menu)	PF		999	
	CF		Pb1	Pb1
(Global Menu)				
	&	rt.d	0.0	...
		In.1	25	...
(Input Menu)			9999	
			Pb1	Pb1
	US	&	0	...
(Calibration Menu)	DFL		14	...
(Global Menu)	PF		555	
	CF		Pb1	Pb1
	&	rt.d	0.0	...
(Input Menu)		In.1	14	...
			9999	
			Pb1	Pb1
	S1		0.0	...
(Calibration Menu)	DFL		30	...
			999	% of span
			Pb1	Pb1

Operation-PID

rE1

Output 1 Reset

Tune the control action to eliminate the offset or droop between the set point and the actual process value for PID output 1. When set to **0.00**, reset is disabled.

rE1 This prompt appears only if **dFL** (Calibration Menu) is set to **US** and **Pb1** is not set to **0**.

Default



0.00 ... **9.99** repeats/min.

rE1 **rE1**

IE1

Output 1 Integral

Tune the control action to eliminate the offset or droop between the set point and the actual process value for PID output 1. When set to **0.00**, integral is disabled.

IE1 This prompt appears only if **dFL** (Calibration Menu) is set to **SI** and **Pb1** is not set to **0**.

Default



0.00 ... **99.99** min. / repeat

IE1 **IE1**

rA1

Output 1 Rate

Tune the rate to eliminate overshoot on startup or after the set point changes. The rate setting will not influence the percent power if the process value is more than twice the proportional band from the set point. When set to **0.00**, rate is disabled.

rA1 This prompt appears only if **dFL** (Calibration Menu) is set to **US** and **Pb1** is set higher than **0**.

Default
 ↓
0.00 ... **9.99** min.
rA1 **rA1**

dE1

Output 1 Derivative

Tune the derivative to eliminate overshoot on startup or after the set point changes. The derivative setting will not influence the percent power if the process value is more than twice the proportional band from the set point. When set to **0.00**, derivative is disabled.

dE1 This prompt appears only if **dFL** (Calibration Menu) is set to **SI** and **Pb1** is set higher than **0**.

Default
 ↓
0.00 ... **9.99** min.
dE1 **dE1**

Operation-PID

Ct1

Output 1 Cycle Time

Select the time, in seconds, of a complete on/off cycle.

Ct1 This prompt appears only if **In1** (Input Menu) is not set to a process and **Pb1** is set higher than **0**.

NOTE:
For more information on burst fire, **brst**, see Chapter 9.

	If ↓		Default ↓	
mechanical relay outputs		5.0 ... 10.0 ... 999.9 sec.		
		Ct1 Ct1 Ct1		
open collector or solid-state relay outputs		brst 0.1 ... 1.0 ... 999.9 sec.		
		Ct1 Ct1 Ct1 Ct1		

Pb2

Output 2 Proportional Band

Select the proportional band for PID output 2. If set to **0** it functions as an on/off control and the switching differential is determined by the **Hyst** value (Output Menu).

Pb2 This prompt appears only if **Out2** (Output Menu) is set to **HL** or **CL**.

	If ↓		Default ↓	
		US & PF 0 ... 25 ... 999		
		dFL C_F Pb1 Pb1 Pb1		
		(Calibration Menu) (Global Menu)		
		& rt.d 0.0 ... 25 ... 999.9		
		In1 Pb1 Pb1 Pb1		
		(Input Menu)		
		US & PC 0 ... 14 ... 555		
		dFL C_F Pb1 Pb1 Pb1		
		(Calibration Menu) (Global Menu)		
		& rt.d 0.0 ... 14 ... 999.9		
		In1 Pb1 Pb1 Pb1		
		(Input Menu)		
		S1 0.0 ... 3.0 ... 99.9 % of span		
		dFL Pb1 Pb1 Pb1		
		(Calibration Menu)		

rE2

Output 2 Reset

Tune the control action to eliminate the offset or droop between the set point and the actual process value for PID A output 2. When set to **0.00**, reset is disabled.

rE2 This prompt appears only if **dFL** (Calibration Menu) is set to **45** and **P62** is set higher than **0**. When set to **0.00**, reset is disabled.

Default



0.00 ... **999** repeats/min.

rE2 **rE2**

1E2

Output 2 Integral

Tune the control action to eliminate the offset or droop between the set point and the actual process value for PID output 2. When set to **0.00**, integral is disabled.

1E2 This prompt appears only if **dFL** (Calibration Menu) is set to **51** and **P62** is set higher than **0**.

Default



0.00 ... **99.99** min./repeat

1E2 **1E2**

Operation-PID

rR2

Output 2 Rate

Tune the rate to eliminate overshoot on startup or after the set point changes. The rate setting will not influence the percent power if the process value is more than twice the proportional band from the set point. When set to **0.00**, rate is disabled.

rR2 This prompt appears only if **dFL** (Calibration Menu) is set to **US** and **Pb2** is set higher than **0**.

Default



0.00 ... **9.99** min.
rR2 **rR2**

dE2

Output 2 Derivative

Tune the derivative to eliminate overshoot on startup or after the set point changes. The derivative setting will not influence the percent power if the process value is more than twice the proportional band from the set point. When set to **0.00**, derivative is disabled.

dE2 This prompt appears only if **dFL** (Calibration Menu) is set to **S1** and **Pb2** is set higher than **0**.

Default



0.00 ... **9.99** min.
dE2 **dE2**

ct2

Output 2 Cycle Time

Select the time, in seconds, of a complete on/off cycle.

ct2 This prompt appears only if **cntl** (Global Menu) is not set to **scd** and **pb2** is set higher than **0**.

NOTE:
For more information on burst fire, **brst**, see Chapter 9.

	If ↓	Default ↓
mechanical relay outputs	ct2	5.0 ... 10.0 ... 999.9 ct2 ct2 ct2
open collector or solid-state relay outputs	brst ct2	0.1 ... 1.0 ... 999.9 ct2 ct2 ct2

db

Dead Band

Select the width of the zone between the action of the heating output (reverse acting) and the cooling output (direct acting). If you select a positive value the heat and cool outputs cannot be energized at the same time. If you select a negative value, both outputs can be energized at the same time.

db This prompt appears only if **pb2** is set higher than **0** and one output performs heating action and another performs cooling action.

NOTE:
Decimal points may not always be in the position specified below depending on the the settings of the Decimal 1 **dec1** or Set Point 1 **sp1** parameter in the Input Menu.

	If ↓	Default ↓
(Global Menu)	pf cf	-999 ... 0 ... 999 db A db A db A
(Global Menu)	pc cf	-555 ... 0 ... 555 db A db A db A
a process input is selected		-999 ... 0 ... 999 units db A db A db A

Notes

Chapter 6 The Factory Menus



CAUTION:
When navigating thru the Factory Menus, outputs will be disabled.

NOTE:
The Factory Menu will not appear if the hardware lockout DIP is set to on. See Chapter 1 for more information.

NOTE:
The Factory Menu can only be entered when the setup prompt **SEt** is displayed.

NOTE:
Press the Display key **DISP** to return to the Display Loop from any point in any menu.

Navigating the Factory Menu

To reach the Factory Menu, begin in the Display Loop and press the Up-arrow and Down-arrow keys together and hold for three seconds. The **SEt** prompt will appear in the lower display. Press and hold the Up-arrow and Down-arrow keys together again for three seconds until the **Fcty** prompt appears in the lower display. The Factory Menu will not appear if the hardware lockout DIP is set to on. (See Chapter 1 for more information on DIP switch settings.) The two Factory Menus are Diagnostics **d,AG** and Calibration **CAL**. Upon reaching the Factory Menu prompt **Fcty** use the Up-arrow or Down-arrow key to select a menu and the Mode key **MODE** to step through a menu.

You will not see every prompt in any of these menus. The unit's configuration and model number determine which prompts appear. After stepping through each menu, the Series 982 returns to the Factory Menu prompt **Fcty**. Use the Up-arrow and Down-arrow keys to select the next menu, or use the Mode key **MODE** to advance through the same menu again. To move backwards through the menu hold down the Mode key **MODE** and press the Up-arrow key . Use the Up-arrow or Down-arrow key to change the prompt setting.



① Press the Up-arrow and Down-arrow keys together and hold until the **SEt** prompt appears in the lower display. Press and hold again until the **Fcty** prompt appears in the lower display.

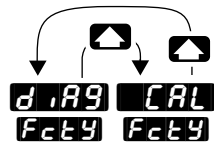

Diagnostics Menu p. 6.2 Calibration Menu p. 6.7

Figure 6.1 - Navigating the Factory Menu.



② Use the Up-arrow key to select one of the Factory Menus.

Factory-Diagnostics

Reaching the Diagnostics Menu



3 Select the Diagnostics Menu **d.1A9**, then press the Mode key **MODE** to step through the prompts.

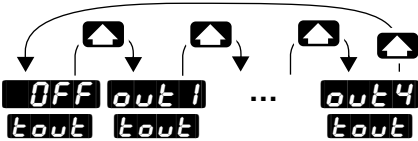
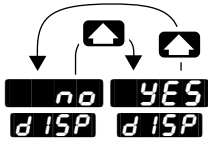

4 Press the Up-arrow key **▲** or the Down-arrow key **▼** to select one of the prompt values.

In the Diagnostics Menu only the values of **disp** and **out** can be changed.

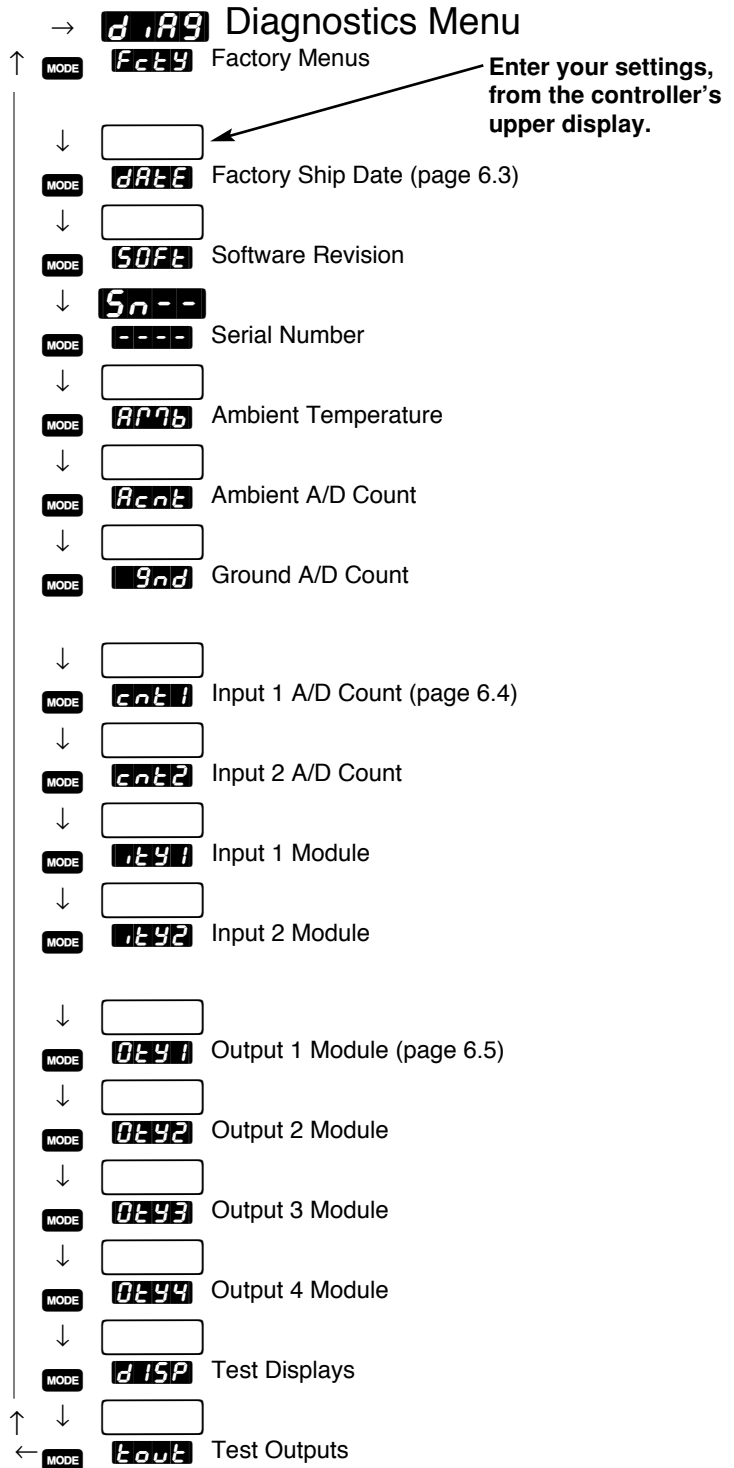

Figure 6.2 - The Diagnostics Menu.

DATE

Factory Ship Date

Shows the date that the final factory control test was performed. The first two digits represent the week as numbered from **01--** to **52--**. The second two digits represent the year **--94**, **--95**, etc...

DATE This prompt always appears.

SOFT

Software Revision

Shows the controller's software revision code. This letter should match the software revision code on the cover of the manual that came with your controller; **---** and W982-XUMN Rev L00.

SOFT This prompt always appears.

Sn--

Serial Number

Shows the controller's serial number. The first two letters in the upper display are to indicate that the controller is in serial number mode. The right half of the upper display shows the first two digits of the serial number. The lower display shows the last four digits of the serial number.

Sn34
5678

This is what the controller with the serial number 0982345678 would display.

Sn-- This prompt always appears.

Factory-Diagnostics

AP7b

Ambient Temperature

Shows the ambient temperature at the Input 1 terminals. The temperature is shown in °F in the form **0000** regardless of the settings of **dEC1**, **dFL** or **C.F**.

AP7b This prompt always appears.

Acnt

9nd

cnt1

cnt2

Factory Use Only

These prompts are used only at the factory.

Acnt 9nd cnt1 cnt2 These prompts always appear.

.tY1

.tY2

Inputs 1 and 2 Module Types

Displays which input module is installed in the controller. Please document this value before contacting the factory for technical assistance.

Input Types

- **none** No input module
- **tc** Thermocouple only module
- **curr** Current detect
- **slid** Slidewire module
- **uoff** Universal off
- **urtd** Universal rtd
- **utch** Universal high-gain thermocouple
- **utcl** Universal low-gain thermocouple
- **uprv** Universal millivolts
- **uprc** Universal process
- **e.2** Event input 2

.tY1 .tY2 These prompts always appear.

0EY1

0EY2

0EY3

0EY4

Outputs 1, 2, 3 and 4 Module Types

Displays which output module is installed in the controller. Please document this value before contacting the factory for technical assistance.



Output Types

- **none** no output module
- **SSr1** 0.5A solid-state relay
- **SSIS** 0.5A solid-state relay with suppression
- **SSr2** 2.0A solid-state relay
- **SS2S** 2.0A solid-state relay with suppression
- **dc** switched dc output
- **rLYc** form C relay
- **rLcS** form C relay with suppression
- **rLAb** relay A/B
- **rAbS** relay A/B with suppression
- **Proc** process output
- **UrEt** voltage/retransmit
- **IrEt** current/retransmit
- **SPLY** power supply
- **232** EIA/TIA-232 communications
- **485** EIA/TIA-485 or EIA/TIA-422 communications

0EY1 0EY2 0EY3 0EY4 These prompts always appear.

d 15P

Test Displays

Runs a brief test of the controller's displays and LEDs. To run the test, scroll through the Diagnostics Menu until **d 15P** is shown in the lower display. Use the Up-arrow key  or Down-arrow key  to select **YES** from the upper display and press the mode key **MODE**.

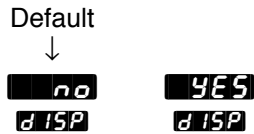

The controller will run pattern tests, blink all the LEDs on and off, and end with the model number in both displays.

d 15P This prompt always appears.



tout

Test Outputs



This prompt tests each output. To run the test, scroll through the Diagnostics Menu until **tout** is shown in the lower display. Use the Up-arrow key  or Down-arrow key  to select an output **out 1**, **out 2**, **out 3**, or **out 4**. The LED for that output should light after a second or two indicating that the output has been successfully energized. Do not press the mode key **MODE** to activate the test; it starts automatically when anything other than **OFF** is selected.



If any of the LEDs fail to light contact the factory.

tout This prompt always appears.



Reaching the Calibration Menu

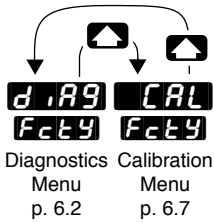

1 Begin in the Display Loop, and press the Up-arrow  and Down-arrow  key simultaneously for six seconds until the Setup Menu **SET**, then the Factory Menu **Fcty** appears.

2 Use the Up-arrow key  or Down-arrow key  to step through the Factory Menu to the Calibration Menu **CAL**.

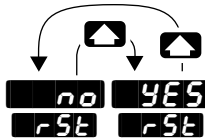

3 Press the Mode key **MODE** to step through the prompts.



4 Press the Up-arrow key  or the Down-arrow key  to select one of the prompt values.

Refer to *Calibrating Watlow Process Controls* for information about the Calibration Menu.



CAUTION:

Before attempting to calibrate, make sure you have the proper equipment called for in each procedure. The Series 982 is calibrated and tested before it leaves the factory. Attempting to calibrate the controller without the proper equipment could result in damage to property and/or equipment.

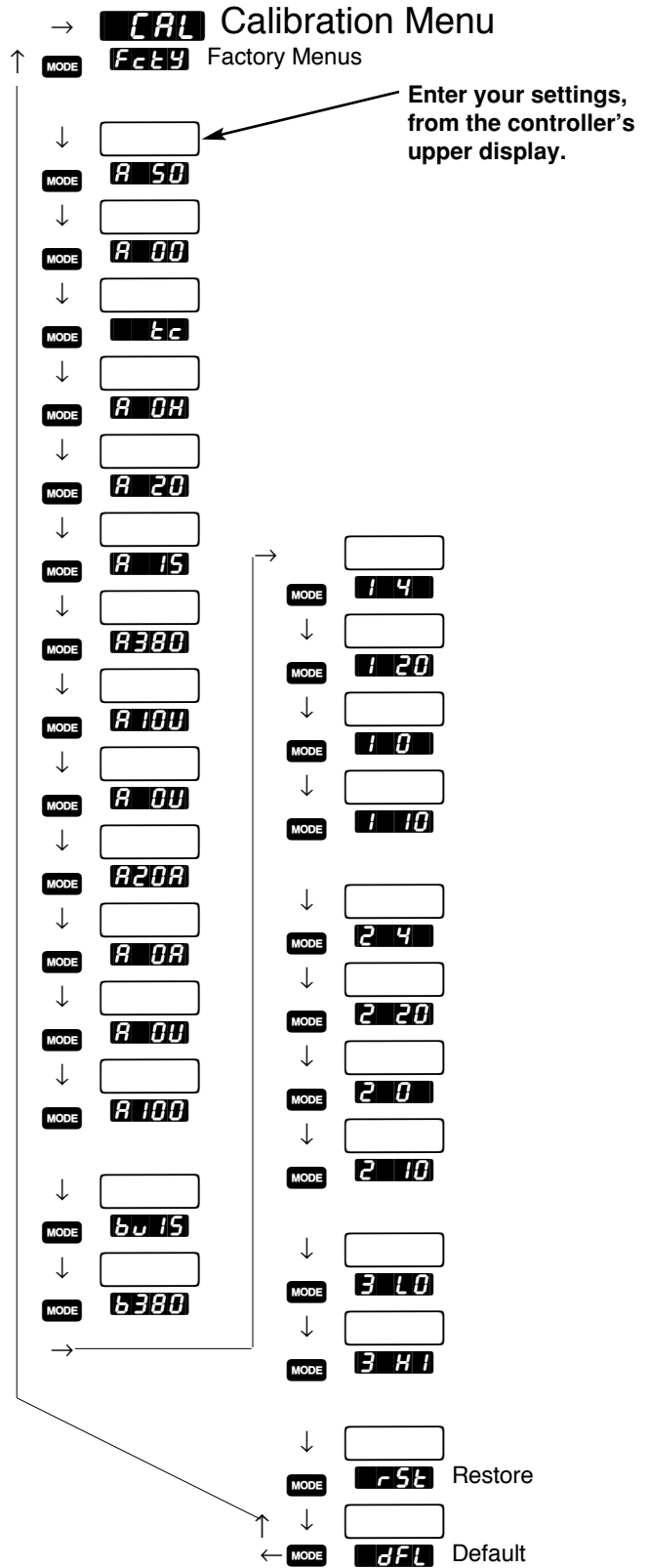

Figure 6.7 - The Calibration Menu.

Factory-Calibration

rSt

Restore

Restores the original factory calibration values. This is a simple way to recover from a mistake made while calibrating the controller.

rSt This prompt always appears.

Default



no **YES**
rSt **rSt**

dFL

Default

Set the operating parameter defaults to domestic or international measures.

- **US** (domestic) sets the controller to °F; rate in minutes; proportional band in degrees or units; and reset in repeats per minute.
- **SI** (international) sets the controller to °C; derivative in minutes; proportional band in percent of span; and integral in minutes per repeat.

dFL This prompt always appears.

Default



US **SI**
dFL **dFL**

Chapter 7 The Run Menu

How to Program and Run the Series 982

In this chapter, we define each parameter of the Program Menu. A description of a few Series 982 features follows, along with a sample profile to experiment with programming the Series 982. You will quickly grasp the necessary terms and concepts by programming and running your profiles. Enter your profile values in the Master Step Chart at the end of the chapter.

Program Menu

Create your ramp and soak profiles here in the Program menu. You have the choice of up to four profiles with up to six steps each. Each step can be programmed for one of five step types. Choose one step type per step.

Program Prompts

Entering the program menu: Push the Mode key until the OPEr prompt appears. Use the Up or Down key to select Prog in the upper display. Press the Mode key to enter the Program menu.

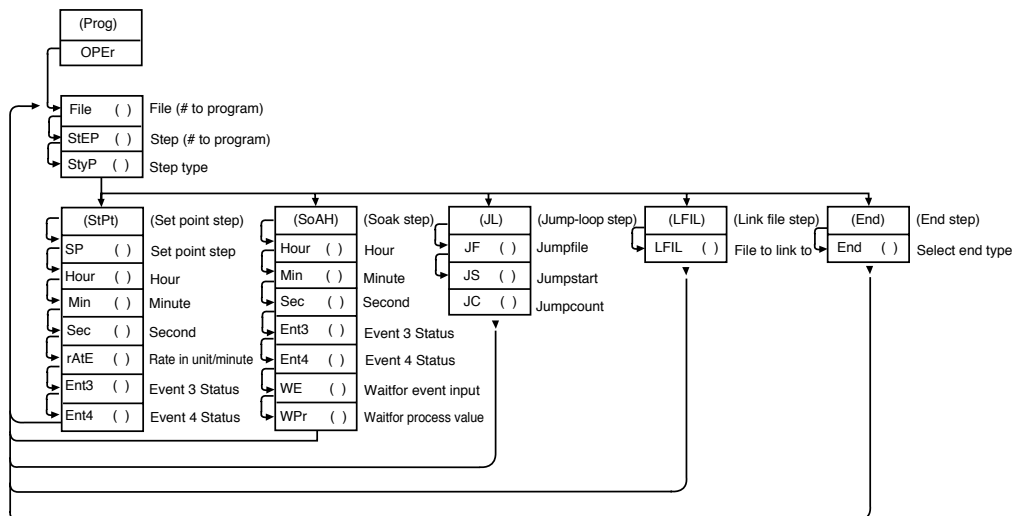

Figure 7.1 - The Program Menu.

FILE

File: Represents the profile to be edited or viewed.

Range: 1 to 4

Default: 1

STEP

Step: Represents the current step of the profile to be edited or viewed.

Range: 1 to 6

Default: 1 then automatic increment

Program Menu

NOTE:

Decimal points may not always be in the position specified depending on the value of Decimal 1 in the Input Menu.

StYP

Step Type: Choose from five different step types. When selecting Step 1, you will not see the jump-loop (JL) or link file (LFiL) step type.

Range: StPt, SoAh, JL, LFiL or End

Default: End

StPt

Set Point Step (StPt) : The following parameters are associated with the set point step.

SP

Set Point: The temperature the system tries to achieve for this step. This is done linearly, producing a ramp from a beginning set point to this end set point.

Range: rL1 to rH1

Default: 75°F/24°C or rL value if $rL \geq 75^\circ\text{F}/24^\circ\text{C}$ or if $rH \leq 75^\circ\text{F}/24^\circ\text{C}$

Hour

Hour: The number of hours, plus the Min and SEC parameters equal the total step time to achieve the temperature under the StPt step type.

Range: 0 to 99

Default: 0

Hidden if: PtYP = rAtE

Min

Minutes: The number of minutes plus the Hour and SEC parameters equal the total step time to achieve the temperature under the StPt step type.

Range: 0 to 59

Default: 0

Hidden if: PtYP = rAtE

SEC

Seconds: The number of seconds plus the Hour and Min parameters equal the total step time to achieve the temperature under the StPt step type.

Range: 0 to 59

Default: 0

Hidden if: PtYP = rAtE

rAtE

Rate: Represents the rate at which the set point changes in degrees per minute. Decimal point location dependent on dEC1 (decimal 1) prompt.

Range: 0.0 to 360.0°F/0.0 to 200.0°C or 0.0 to 360.0 units

Default: 0.0

Hidden if: PtYP = ti

Ent3

Event 3: Selects whether Event 3 is on or off.

Range: On or OFF

Default: OFF

Hidden if: Hardware not present or Ot3 = AL3, AL3n or no

Ent4

Event 4: Selects whether Event 4 is on or off.

Range: On or OFF

Default: OFF

Hidden if: Hardware not present or Ot4 = AL4, AL4n or no

SoAH

Soak: The following parameters are associated with the soak step.

Hour

Hour: The number of hours plus the Min and SEC parameters equal the total step time at temperature under the SoAH step type.

Range: 0 to 99

Default: 0

Min

Minutes: The number of minutes plus the Hour and SEC parameters equal the total step time at temperature under the SoAH step type.

Range: 0 to 59

Default: 0

SEC

Seconds: The number of seconds plus the Hour and Min parameters equal the total step time at temperature under the SoAH step type.

Range: 0 to 59

Default: 0

Ent3

Event 3: Selects whether Event 3 is on or off. Only appears if Ot3 = Ent3.

Range: On or OFF

Default: OFF

Hidden if: Hardware not present or Ot3 = AL3, AL3n or no

Ent4

Event 4: Selects whether Event 4 is on or off. Only appears if Ot4 = Ent4.

Range: On or OFF

Default: OFF

Hidden if: Hardware not present or Ot4 = AL4, AL4n or no

WUE

Waitfor Event Input: The program will wait at this step until the desired status of the event is satisfied. Selecting dSbL disables this feature. See Chapter 7.

Range: dSbL, On or Off

Default: dSbL

Hidden if: Ei1 and Ei2 not equal to WE

WPr

Waitfor process crossover value: The program will wait at this step until the desired process value is reached. If gSd is greater than zero the closest edge of the guaranteed soak band is the process crossover value. Selecting dSbL disables this feature. If time also entered, countdown will not begin until WPr has been satisfied. See Chapter 7.

Range: dSbL, rL1 to rH1

Default: dSbL

Program Menu

JL

Jump-loop Step (JL) : The following parameters are associated with the jump-loop step. When StEP = 1, JL will not appear.

JF

Jump File: Jumps to the selected file and step (see Jump Step, below), when the jump file value is not equal to current file. If the jump file value equals the current file, only steps less than the current program step are valid selections for a jump step. Changing the jump file value defaults the jump step to 1. This is a zero-time step.

Range: 1 to 4
Default: current file

JS

Jump Step: Jumps backwards to any step in your file, if the jump file value equals the current file (see Jump File, above). Otherwise you can jump to any valid step number. This is a zero-time step.

Range: 1 to 6
Default: 1

JC

Jump Count: The number of times the Series 981/982 jumps to the step specified by the JS (jump step) parameter. 0 = infinite number of jumps.

Range: 0 to 255
Default: 0

LFiL

Link File (LFiL): The following parameter is associated with the link file step. When StEP = 1, LFiL will not appear.

LFiL

Link File: Selects the file to link to. This is a zero-time step. It will not be shown in the run menu. The control advances to the first step of the file to be linked to.

Range: 1 to 4
Default: 1

End

End Step (End) : The following parameter is associated with the end step.

End

End: Selects the state of the control and auxiliary outputs when a profile is ended. When HoLd is selected, the control and auxiliary outputs are enabled and maintain the same state as in the last set point and/or soak step before the End step was encountered. When selected as OFF, the control and auxiliary outputs will be disabled and OFF is shown in the lower display.

Range: HoLd or OFF
Default: HoLd

Running a Series 982 Profile

You can run your Series 981/982 profile from anywhere except the Setup menus or Factory menus or when the control is auto-tuning. Press the Hold/Run key once. The RUN LED begins flashing, and the lower display flashes FiLE and asks what FiLE is to be run. Use the Up or Down keys to select the file number in the upper display, choices are 1, 2, 3, or 4. Press the Mode key and the lower display flashes StEP and asks what StEP is to be run. Use the Up or Down keys to select the StEP number in the upper display, choices are 1 through 6. Press the Hold/Run key once again, your profile begins, and the RUN LED is lit. If you decide not to run a profile, press the Display key to exit the Pre-Run menu.

If the none of the keys are pressed within 1 minute, the RUN function will abort. While the profile is Running, you can only view the RUN menu. Press the Mode key to advance you through the RUN menu. For more information on the RUN menu see Chapter 7.

Resume a Profile

To resume a halted profile, press the Hold/Run key once. Press the Mode key to advance to the rESU parameter. The lower display will show rESU and the upper display will show the file and step number that will be resumed (file-step). Press the Hold/Run key again, the profile resumes, and the RUN LED is lit. You can only resume at the exact step you left off on. If you halt a running profile and make changes, you cannot resume the profile. The rESU parameter only appears when a running profile is halted.

To Run your profile... Press the Hold/Run key twice.

To Stop a running profile... Press the Hold/Run key once.

To Resume a halted profile... Press the Hold/Run key, press the Mode key to advance to the rESU parameter, and press the Hold/Run key.

Pre-Run and Run Menus

The Pre-Run and Run menus are only visible when in the Pre-Run or Run mode. The Pre-Run mode is defined as the mode during which the file and step number of the program to run is selected and consists of the FILE, StEP and rESU prompts. The FILE and StEP prompts are also visible in the Run menu showing the current file and step number. The remaining prompts in the Run menu show the status of the process, the program being run and the auxiliary outputs. The Display key functions in the Run mode as it does in the Hold mode. The Display key will return the display to the process/current set point display and can be used to display pertinent information about the process.

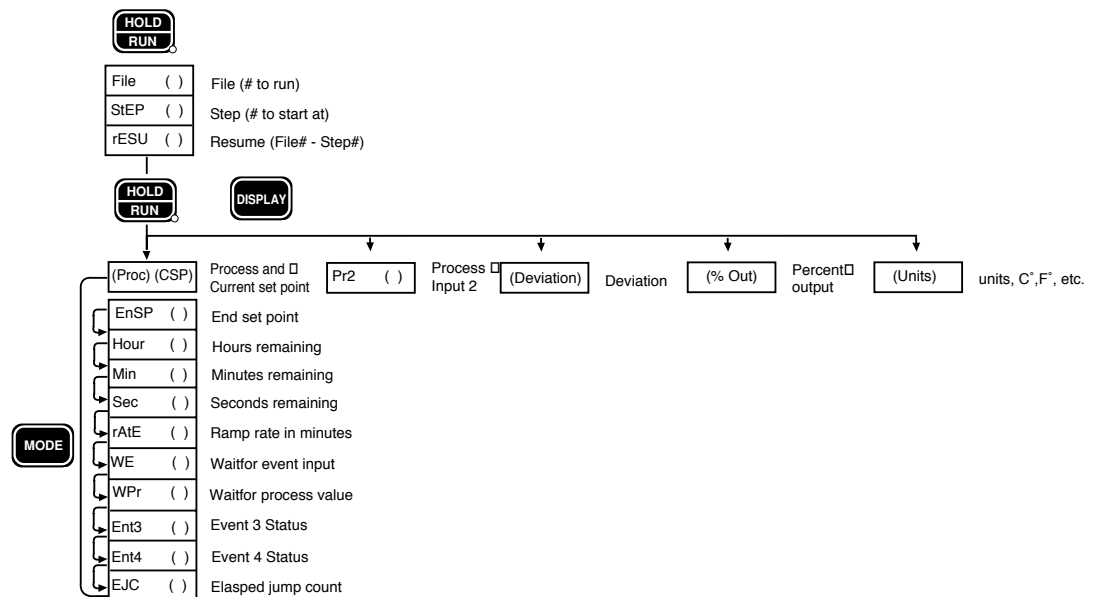

Figure 7.6 - The Pre-Run and Run Menus.

Event Outputs

One of the features of the Series 981/982 is its capability for two event outputs. An “event output” is simply a pre-programmed ON/OFF event per profile step. The event may turn any number of peripheral devices ON or OFF to assist you in controlling your process, system or environment.

For instance, in an environmental chamber, you might wish to circulate air at a given time in your profile for one or more steps. You might want to turn lights on or off, or signals, or lock out your humidifier, or you could activate a video recorder.

The event output prompts, Ent3 and Ent4, are not visible under the Operation menu unless your unit has outputs 3 and 4 and you setup Ot3 and Ot4 as events.

To select outputs 3 and 4 as events, enter the Setup menu by pressing the Up/Down keys simultaneously for 3 seconds. The SEt parameter appears in the lower display. Press the Up or Down key until OtPt is shown in the upper display. Press the Mode key until you reach the Ot3 parameter. The default for Ot3 is AL3 (alarm 3). Change the value to Ent3 (event 3) if it hasn't already been done. Press the Mode key to continue on to the Ot4 parameter. Do the same for this parameter also. Press the Display key to exit the Setup menu.

If you return to the System menu, Ent3 and Ent4 are visible, and can be turned on or off from here. Ent3 and Ent4 can also be viewed under the StPt (Set Point) and SoAH (Soak) parameters in the Program Menu. **Select the correct jumper for contact closed with event ON (NO) or contact open with event ON (NC).**
See Chapter 8.

Guaranteed Soak Deviation

The Series 981/982 Guaranteed Soak Deviation (gSd) feature insures that the actual temperature tracks a programmed profile within a window around set point. See the example **below**. If the deviation is exceeded, the time clock stops and the lower display alternately flashes gSd and the current parameter until the process variable returns within the window. Programmed in degrees or units, gSd is located in the Setup-gLbL menu. Entering a value of (0) disables the Guaranteed Soak Deviation function. Entering a value greater than zero sets up a plus and minus deviation about set point.

Jump-loops

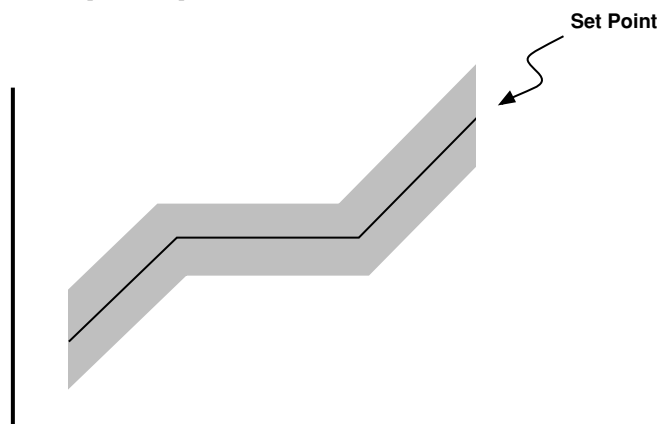

Figure 7.7 -
Guaranteed Soak
Deviation Window
around Set Point.

Sample Program

The Series 981/982 can only jump backwards within the same profile if JF equals the current program profile. A jump forces you to a step already performed. The Jump Step (JS) must be less than the current step. You cannot jump-loop to the step that you are on.

Example:

Step 1	StPt Step		
Step 2	StPt Step		
Step 3	Soak Step		
Step 4	StPt Step		
Step 5	Jump-loop	JS - 2	JC - 1
Step 6	End		

In this example the program will execute steps 2 through 4 a total of 2 times. This includes the initial pass and the pass associated with the Jump Count of 1 (JC - 1). Following the second pass the End step (Step 6) will be executed and the program will end.

Your Jump Count (JC) can be anything from 0 to 255. If you enter 0, this will be an infinite loop and never progresses to Step 6.

When Jump File is not set to the current program step, the profile may jump to any step of another file. In this example Jump File enables the profile to jump between two files.

Programming a Ramping Profile

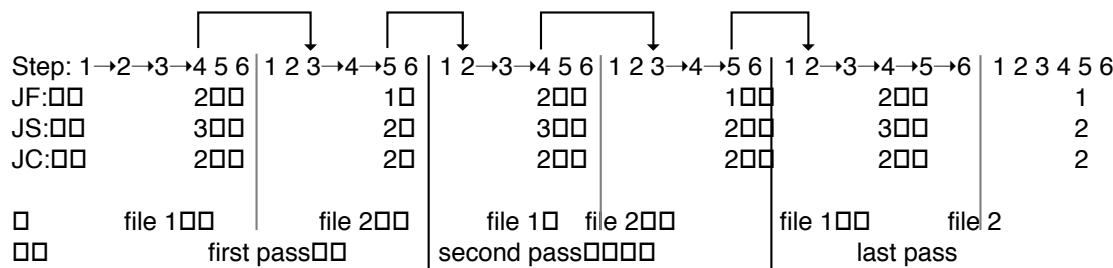

Figure 7.8 - Using Jump File.

This is a sample program. Depending on your application and parameter settings, your system may not respond like this.

Our first step in programming is to make a short ramp and soak profile. Step 1 initializes the set point to a known starting point for the ramp, Step 2 is a short ramp, and Step 3 is a soak step, which holds the programmed set point constant for the programmed time. Step 4 is an end step signaling the end of the profile.

1. Enter the Operation menu by pressing the Mode key until OPER appears in the lower display. Use the Up or Down key to select Prog in

the upper display. Press the Mode key to enter the Program menu.

2. The Series 981/982 asks you for a FiLE. The upper display reads 1. Press the Mode key to select file 1.
3. The Series 981/982 asks you for a StEP. The upper display reads 1.
4. Press the Mode key to select step 1 and you are asked for a step type (StyP). The default is End. Use the Up or Down key to select StPt (set point).
5. Use Table 7.9 to enter the corresponding parameters and values. The parameters appear from left to right on the table. Remember that the Mode key is used to progress through the menu, and the Up and Down keys are used to select parameters and values.

NOTE: If auxiliary outputs are not present or Ot3 and Ot4 are selected as alarms, the Ent3 and Ent4 parameters will not appear in the program

Step #	StyP (Step Type)	Set Point	Hour	Min	SEC	Ent3	Ent4	WE	WPr	End
1	StPt	75	0	0	1	OFF	OFF	--	--	--
2	StPt	100	0	0	25	On	OFF	--	--	--
3	SOAH	--	0	0	25	ON	OFF	dSbl	dSbL	--
4	End	--	--	--	--	--	--	--	--	OFF

menu. If Event Input 1 or 2 is not selected as a waitfor event, the WE

**Table 7.9 -
Sample Program.**

parameter will not appear in the program menu.

Running Your Profile

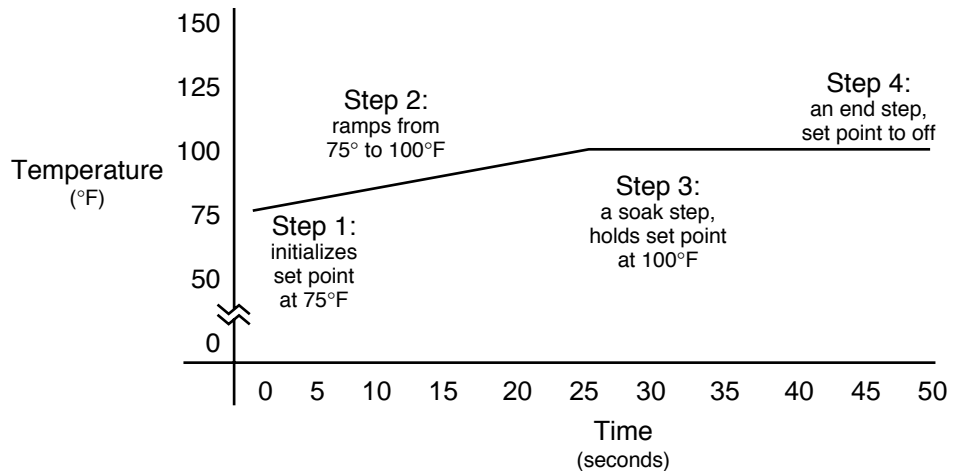

**Figure 7.9 -
Ramp and Soak
Profile.**

Sample Program

1. Start your profile by pressing the Hold/Run key. You can be at any point except in the Setup or Factory menus or with the control in the auto-tune mode.
2. The Run LED begins flashing. The upper display shows the file number to be run and the bottom display shows the FiLE parameter.
3. Press the Mode key, the upper display shows the step number to be run and the bottom display shows the StEP parameter.
4. Press the Hold/Run key again. (If not pressed within approximately 1 minute, the Run procedure will abort.) The profile starts running.

The Run LED is continually lit. The upper display shows the process value, and the lower display shows the current set point.

You may step through the Run menu parameters with the Mode key while the profile is running. The Run menu will show the file number, step number, the step type and what the parameters are set to. At any time you may press the Hold/Run key to stop the profile. To resume running the profile where it was stopped, press the Hold/Run key once; the Run LED begins flashing. Now, press the Mode key to advance to the rESU parameter; once again, press the Hold/Run key. After the profile has ended the Run LED is off and the lower display reads OFF. This means the End step was selected as OFF, disabling all outputs.

Editing Your Profile

Now let's try editing the profile by expanding it with another ramp step, adding a jump-loop and allowing the program to end in a Hold mode. It is possible to expand the number of steps in a file to 7 if the final step can be an End-Hold step. We'll jump to Step 2 and repeat Steps 2 through 5 two more times. This is accomplished by programming a Jump Step (JS) = 2 and Jump Count (JC) = 2. This means that once the Series 981/982 goes through the profile and reaches Step 6 it jumps back to Step 2 and repeats the profile two more times (Steps 2 - 5). The program then ends and holds the set point and event status of the last step of the profile prior to ending the program.

Sample Program

By this time you should understand the basic concept of the Series 981/982 and be able to get around on your own. Remember that the Mode key takes you through the menus and the Up/Down keys select parameters and values.

1. Return to the Program menu by selecting Prog at the OPEr prompt. Press the Mode key.
2. Press the Mode key again and select 4 when StEP appears. We are going to change this step type from an End step to a Set Point step. This is our second ramp. Use Table 7.11 to enter values into the corresponding parameters.
3. Once you have edited your profile, run it again and watch its progress.

Step #	StyP (Step Type)	Set Point	Hour	Min	SEC	Ent3	Ent4	WE	WPr	JF	JS	JC
4	StPt	125	0	0	25	OFF	On	—	—	—	—	—
5	SoAH	—	0	0	25	On	OFF	—	—	—	—	—
6	JL	—	—	—	—	—	—	—	—	1	2	2

Table 7.11 - Editing your Profile.

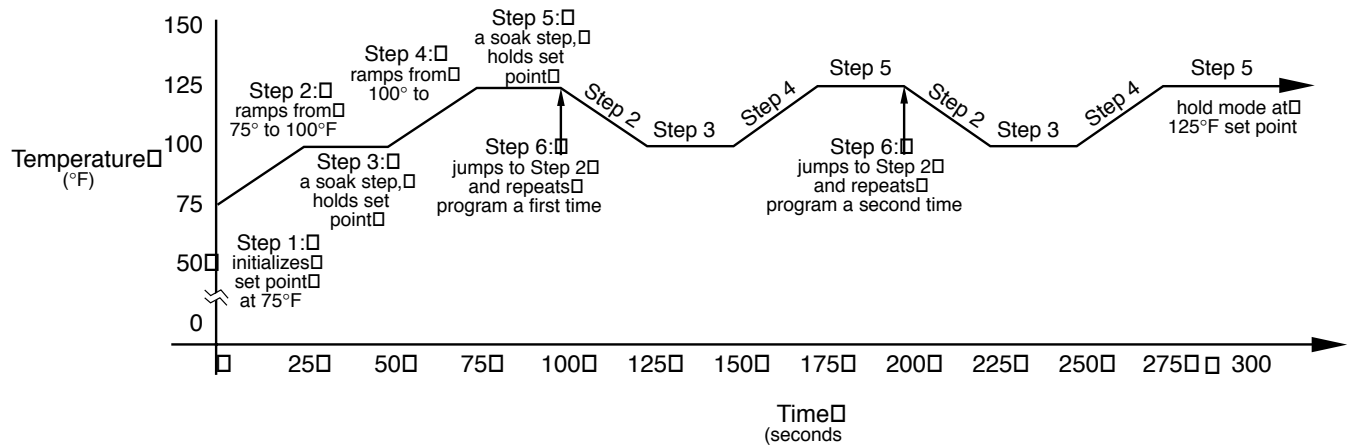

Figure 7.11 - Ramp/Soak with Jump-loop.

Sample Program

Linking Profiles

The Series 981/982 enables you to link files together. The Link step allows you to link any step other than the first step of a profile to the first step of another profile.

Let's edit the profile again by adding a Link step to the end of File 1 in place of the Jump-loop step. But first lets create another profile by programming profile 2. Follow Table 7.12 to add a Link step to File 1 to link it to File 2.

Run your program again beginning with File 1. Step through the Run menu by using the Mode key. See what happens at the end of File 1.

File #	Step #	StyP (Step Type)	Set Point	Hour	Min	SEC	Ent3	Ent4	WE	WPr	LFIL	End
1	6	LFIL	—	—	—	—	—	—	—	—	2	—
2	1	StPt	175	0	0	25	On	On	—	—	—	—
2	2	SoAH	—	0	0	25	On	On	—	dSbL	—	—
2	3	StPt	100	0	0	25	On	OFF	—	—	—	—
2	4	SoAH	—	0	0	25	On	OFF	—	dSbL	—	—
2	5	StPt	75	0	0	25	OFF	OFF	—	—	—	—
2	6	End	—	—	—	—	—	—	—	—	—	Hold

Table 7.12 - Linking Profiles.

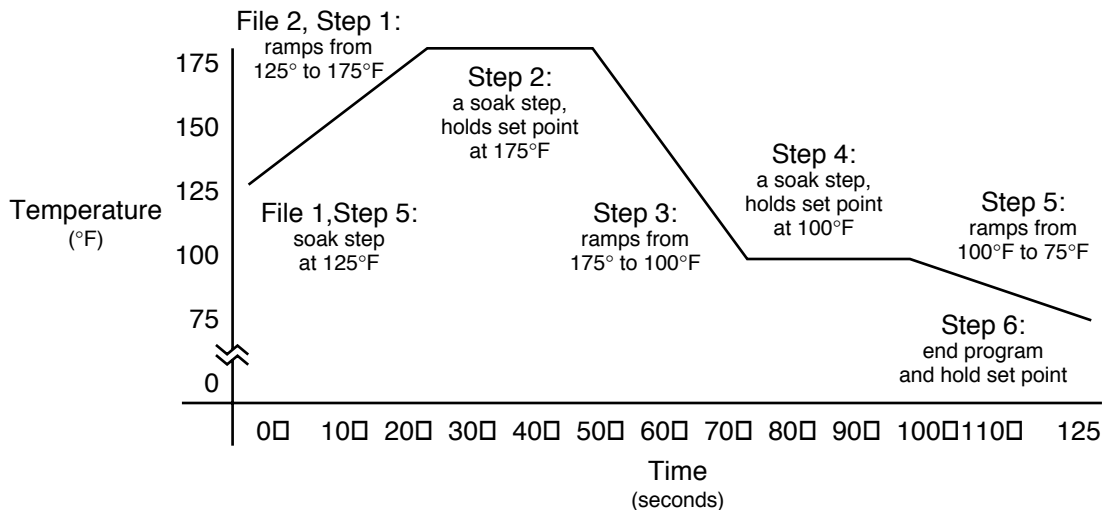

Figure 7.12 - Linking Profiles.

The Waitfor Functions of the Soak Step

In the previous profiles we have used the Soak step but have not used the waitfor function for this step. There are two waitfor functions. The first being the wait for event (WE). If selected as On or OFF the Series 981/982 will wait, the program clock will stop and the profile will be held, until the appropriate action is seen at the event input terminals, closed for ON and open for OFF. If the [WE] parameter is set to disable (dSbL) the function will be ignored. The second waitfor function is wait for process crossover value (WPr). If a value is entered under this prompt the profile will wait at this step until the desired process value is reached.

Both waitfor functions (if enabled) must be satisfied before the time entered in the SoAH step is decremented.

Master Step Chart

Make photocopies, keep original clean.

File #

Step #	Step Type	Set Point	Time			Events				Values	
						On	Off	On	Off		
	StPt	SP	Hour	Min	SEC	Ent3		Ent4			
			rAtE								
	SoAH		Hour	Min	SEC	Ent3		Ent4		WE	WPr
	JL								JF	JS	JC
	LFIL								LFIL		
	End								End		

Step #	Step Type	Set Point	Time			Events				Values	
						On	Off	On	Off		
	StPt	SP	Hour	Min	SEC	Ent3		Ent4			
			rAtE								
	SoAH		Hour	Min	SEC	Ent3		Ent4		WE	WPr
	JL								JF	JS	JC
	LFIL								LFIL		
	End								End		

Step #	Step Type	Set Point	Time			Events				Values	
						On	Off	On	Off		
	StPt	SP	Hour	Min	SEC	Ent3		Ent4			
			rAtE								
	SoAH		Hour	Min	SEC	Ent3		Ent4		WE	WPr
	JL								JF	JS	JC
	LFIL								LFIL		
	End								End		

Step #	Step Type	Set Point	Time			Events				Values	
						On	Off	On	Off		
	StPt	SP	Hour	Min	SEC	Ent3		Ent4			
			rAtE								
	SoAH		Hour	Min	SEC	Ent3		Ent4		WE	WPr
	JL								JF	JS	JC
	LFIL								LFIL		
	End								End		

Step #	Step Type	Set Point	Time			Events				Values	
						On	Off	On	Off		
	StPt	SP	Hour	Min	SEC	Ent3		Ent4			
			rAtE								
	SoAH		Hour	Min	SEC	Ent3		Ent4		WE	WPr
	JL								JF	JS	JC
	LFIL								LFIL		
	End								End		

Step #	Step Type	Set Point	Time			Events				Values	
						On	Off	On	Off		
	StPt	SP	Hour	Min	SEC	Ent3		Ent4			
			rAtE								
	SoAH		Hour	Min	SEC	Ent3		Ent4		WE	WPr
	JL								JF	JS	JC
	LFIL								LFIL		
	End								End		

Table 7.14 - Master Step Chart.

Chapter 8 Operation, Tuning, Alarms and Error Codes

Auto-tuning (Heat and/or Cool)

The Series 981/982 can automatically tune the PID parameters to fit the characteristics of your particular thermal system.

Before beginning the auto-tune sequence, make sure the AtSP parameter located in the Global menu is at the proper setting. This allows the user to select the tuning set point as a percentage of the current control set point. See Chapter 4 for more information on this parameter. The figure below uses the 90% default setting to define the auto-tuning process.

Once the auto-tune sequence has begun, the Output 1 and Output 2 proportional band is set to 0 and the control goes into an ON/OFF mode of control at the set point percentage determined by the AtSP parameter. The displayed set point remains unchanged.

Once the control finishes “learning” the system, it returns to a standard PID control with the PID values automatically set as a result of auto-tuning. Any change in the set point while in auto-tune re-initiates the auto-tune procedure.

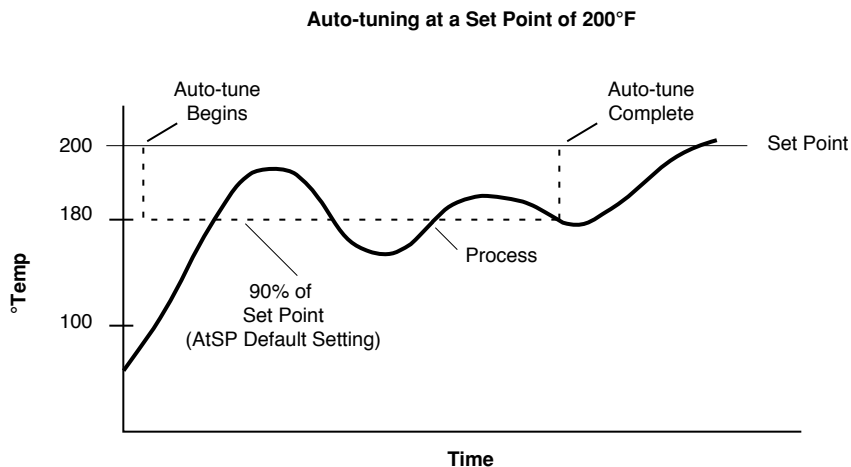

Figure 8.1 - Auto-tuning Example.

Once auto-tune has begun, the process must cross the auto-tune set point four times within an 80 minute time span for the 981/982 to successfully complete auto-tune. If this does not happen within the 80 minute time limit, the Series 981/982 chooses PID values based on the 80 minute tuning cycle performed.



To start auto-tuning:

1. **Press the Mode key** until the **AU**t prompt appears in the lower display.
2. **Use the Up/Down key** to select Pid in the upper display.
3. **Press the Display key**. While the control is in the tuning mode, the lower display alternately displays the normal information and the tunE prompt. The time between alternations is 1 second.
4. **When tuning is complete**, the displays return to their previous state and AUt reverts to OFF. The 981/982 installs appropriate PID tuning parameters and saves them in non-volatile memory.

To abort auto-tuning either reset the AUt prompt to OFF, or cycle power off and on. In all cases, aborting auto-tune restores all values to those previous to auto-tuning.

Manual Tuning



For optimum control performance, tune the Series 981/982 to your thermal system. The tuning settings here are for a broad spectrum of applications; your system may have somewhat different requirements. NOTE: This is a slow procedure, taking from minutes to hours to obtain optimum values.

NOTE:

Tune heating outputs at a set point above ambient process value. Tune cooling outputs at a set point below ambient process value.

NOTE:

1. **Apply power to the Series 981/982** and enter a set point. Begin with these Operation parameters: **Pb** = 1, **rE/It** = 0.00, **rA/dE** = 0.00, **Ct** = 5.0, **AUT** = OFF.
2. **Proportional Band Adjustment:** Gradually increase **Pb** until the upper display process value stabilizes at a constant value. The process value will not be right on set point because the initial reset value is 0.00 repeats per minute. (When **Pb** = 0, **rE/It**, **rA/dE** and cycle time are inoperative, the 981/982 functions as a simple ON/OFF control.) The HYS prompt determines the switching differential value.
3. **Reset/Integral Adjustment:** Gradually increase **rE**, or decrease **It** until the upper display process value begins to oscillate or “hunt.” Then slowly decrease **rE** or increase **It** until the upper display stabilizes again near set point.
4. **Cycle Time Adjustment:** Set **Ct** as required. Faster cycle times sometimes achieve the best system control. See Chapter 9, “Burst Firing,” for more information. However, if a mechanical contactor or solenoid is switching power to the load, a longer cycle time may be desirable to

NOTE:

You cannot access the AUt prompt while the controller is in run mode.



CAUTION:

If a mechanical relay or contactor is switching power to the load, a longer cycle time may be desirable to minimize wear on the mechanical components. Typical life of a mechanical relay is 100,000 cycles.

minimize wear on the mechanical components. Experiment until the cycle time is consistent with the quality of control you want. **Ct** will not appear on units with a process output (Option "F") or if $P_b = 0$.

5. Rate/Derivative Adjustment: Increase **rA/dE** to 1.00 minute. Then raise set point by 20° to 30°F, or 11° to 17°C. Observe the system's approach to set point. If the load process value overshoots set point, increase **rA/dE** to 2.00 minutes.

Raise the set point by 20° to 30°F, or 11° to 17°C and watch the approach to the new set point. If you increase **rA/dE** too much, approach to set point is very sluggish. Repeat as necessary until the system rises to the new set point without overshooting or approaching the set point too slowly.

6. Calibration Offset Adjustment: You may want your system to control to a process value other than the value coming from the input sensor. If so, measure the difference between that process value (perhaps at another point in the system) and the process value showing in the upper display. Then enter the **CAL** offset value you want. Calibration offset adds or subtracts degrees from the value of the input signal.

Changing the Output 3 Jumper

If you have model number 98_C-____-J____, Output 3 can be configured as a Form A (NO and common contact) or Form B (NC and common contact) output. To change the output jumper:

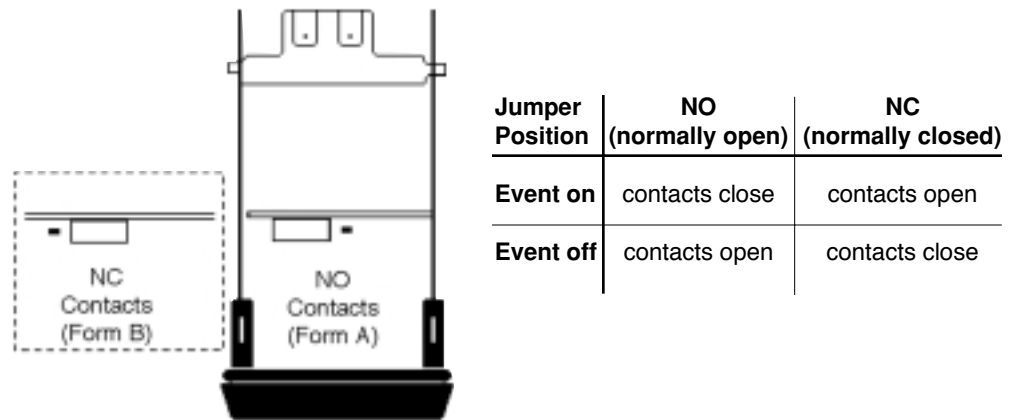

Figure 8.3 - Output 3 Jumper Location.

Control Chassis - Top View

1. Remove the control from the case. Release the two tabs on one side of the control, then release the two tabs on the opposite side. You may need to rock the bezel back and forth several times to release the chassis.

2. Set the jumper to the position you want. See below for jumper location.
3. Return the control chassis to the case. Be sure you have it oriented correctly. Press firmly, but gently, to seat the chassis.

When you select Form A, the contact is open when power is removed from the control. When selecting Form B, the contact closes when power is removed.

Using Alarms

Output 2, 3, and/or 4 of the Series 981/982 can be selected as alarms. This is accomplished in the Output (OtPt) menu under the Ot2, Ot3, or Ot4 prompt. If AL \underline{X} is selected, the output is energized in the non-alarm condition and de-energizes the output in the alarm condition. Selecting AL $\underline{X}n$ reverses this action; the output is then de-energized in the non-alarm condition and energized in an alarm condition.

If the L2, L3 or L4 LED on the front panel is lit, this indicates an alarm condition for Output 2, 3 or 4 respectively.

Once you've configured the outputs as alarms, enter the OtPt menu again and select the AL2, AL3 and/or AL4 prompt respectively. These prompts select the type of alarm, process, deviation or rate. Each may be independently set low and high. Choose between process alarm input 1 (Pr1), deviation alarm input 1 (dE1), or rate (rAtE) alarm referenced to Input 1.

A **process alarm** sets an absolute temperature. When the process exceeds that absolute temperature limit an alarm occurs. A process alarm is independent from set point.

Example: If your set point is 100°F and a process alarm is set at 150°F as the high alarm, and 50°F as the low limit, the high limit trips at 150°F, and the low alarm at 50°F. If you change the set point, the process alarm limits remain the same.

A **deviation alarm** alerts the operator when the process strays too far

Jumper Position	NO (normally open)	NC (normally closed)
In Alarm Condition		
Ot \underline{X} = AL \underline{X}	contacts open	contacts closed
Ot \underline{X} = AL $\underline{X}n$	contacts closed	contacts open
In Non-alarm Condition		
Ot \underline{X} = AL \underline{X}	contacts closed	contacts open
Ot \underline{X} = AL $\underline{X}n$	contacts open	contacts closed

NOTE:
An \underline{X} applies to Alarm 2, 3 and/or 4.

from set point. The operator can enter independent high and low alarm settings. The reference for the deviation alarm is the set point. Any change in set point causes a corresponding shift in the deviation alarm. Low alarms are set at a negative deviation while high alarms are a positive deviation.

Example: If your set point is 100°F and a deviation alarm is set at +7°F as the high limit, and -5°F as the low limit, the high alarm trips at 107°F, and the low alarm at 95°F. If you change the set point to 130°F, the alarms follow the set point and trip at 137°F and 125°F.

NOTE:
An X applies to Alarm 2, 3 or 4.

A **rate alarm** alerts the operator when the process monitored by Input 1 is increasing at a rate higher than that set by AXHI or decreasing at a rate lower than that set by AXLO. The rate is sampled once a second.

Alarms can be latching or non-latching. When the alarm condition is removed, a non-latching alarm automatically clears the alarm output and alarm message, if one is present. You must manually clear a latching alarm before it will disappear.

NOTE:
An alarm display will be masked by an error condition or when the controller is in the Calibration or Setup menus.

An alarm is indicated by the corresponding LED on the front panel, L2, L3 or L4. There may be an alarm message flashing in the lower display, but if the Anun prompt is set to OFF (located in the Global menu), no alarm message is displayed. When an alarm message is displayed, it alternately flashes with the current prompt at a 1 second interval in the lower display.

To clear a latching alarm, first correct the condition then press the Hold/Run key once.

Alarm silencing is available with all alarms. This function overrides the alarm on initial power up. On power up, the alarm message is masked and the appropriate L2, L3 or L4 LED and output reflect a non-alarm condition. The silencing is active until the process has entered the safe region located between the low and high alarm settings. Any future deviation outside this safe region triggers an alarm. If an alarm occurs at this point, the output can be silenced by pressing the Hold/Run key once, but the alarm message is still displayed.

Error Code E1 and E2 Messages

Four dashes, “- - - -”, in the upper display indicate a Series 981/982 error. The lower display will indicate the error code. The controller will be in the Hold mode with both control outputs off. The alarm outputs will be in their alarm state and the associated LED lit.

NOTE:
An X applies to input 1 or 2.

EX 1: A/D underflow error

The Input X A/D circuit is underrange. An open or reversed polarity sensor is the most likely cause. Check the sensor; if the connection is good, and functions properly, call the factory. Make sure the InX prompt matches your sensor.

EX 2: Sensor underrange error

The Input X sensor generated a value lower than that allowed for the range of the sensor, or the A/D circuitry malfunctioned. Enter a valid input. The A/D

NOTE:

An alarm display will be masked by an error condition or when the controller is in the Calibration or Setup menus.

value is below the range limits, but within the A/D conversion limits. Make sure the In \underline{X} prompt matches your sensor.

EX 3: Sensor overrange error

The Input \underline{X} sensor generated a value higher than that allowed for the range of the sensor, or the A/D circuitry malfunctioned. Enter a valid input. The A/D value is above the range limits, but within the A/D conversion limits. Make sure the In \underline{X} prompt matches your sensor.

ER3: Ambient Error

Ambient temperature has gone below 0°C/32°F or above 65°C/149°F. Refer to the restore prompt in the Calibration Menu (Chapter 6).

EX 4: A/D overflow error

The Input \underline{X} A/D circuit is overrange. An open or reversed polarity sensor is the most likely cause. Check the sensor; if the connection is good, and functions properly, call the factory. The A/D input voltage is too high to convert an A/D signal. Make sure the In \underline{X} prompt matches your sensor.

Er4: RAM verification error

Displayed when an internal RAM failure has occurred. Contact the factory.

Er5: Non-volatile checksum error

Displayed when an EEPROM checksum error has been detected. This error will reset all parameters to the factory defaults. Turn the power off then back on again. If the error has not cleared, contact the factory.

Er9: Configuration error

An incorrect module has been installed in the control. Contact the factory.

NOTE:

An \underline{X} applies to Input 1 or 2.

Error Code Actions

• **To clear error codes EX1, EX2, EX3, or EX4:**

- If **Err = nLA**, the error code should clear once the problem is corrected.
- If **Err = LAt**, correct the problem and cycle power. You can also clear the error by pressing the Up/Down keys to enter the Setup menu, then press the Display key.

• **Error codes Er4, Er5, or Er9 will result in these conditions:**

- The control is in Hold mode with both control outputs OFF.
- The alarm outputs are in their alarm state (de-energized with the LED lit).
- The lower display indicates the error code.
- The upper display indicates “ _ _ _ _ ”.
- All keys are inactive.
- With Er5, all prompts return to default values.

Cycle power to the control. If the error is still present contact the factory.

Chapter 9 Software

Burst Fire	9.2
Communications	9.4
Dead Band	9.6
Digital Event	9.8
Input Filter	9.10
Retransmit	9.12
Slidewire Feedback	9.14

Burst Fire

Overview

Variable, time-base burst firing from the Series 982 provides the most even distribution of power with the lowest level of noise generation (RFI). An SSR or SCR firing card translates a command signal into a burst of AC cycles. The output is zero-cross fired, which always allows at least one full AC cycle to pass within the variable time base. Burst firing is the preferred mode to control resistive loads.

The Series 982 detects when the AC sine wave of the load will cross the 0-volt point. It uses this information to switch the load ON or OFF only at a 0-volt point, minimizing RFI.

The burst fire time base in the Series 982 varies from a maximum 1.66-second time base (1-percent output; 1 cycle ON, 99 OFF) down to a 33.3-millisecond time base (50-percent output; 1 cycle ON, 1 OFF). The graphs on the next page show how the time base varies with the percent output.



CAUTION:
This feature only works with zero-cross solid-state devices. It will not function correctly with random-fire devices.



CAUTION:
In single-phase applications the controller should be on the same phase as load.

Requirements

- This feature only works with zero-cross solid-state devices. It will not function correctly with random-fire devices.
- To enable burst fire the Series 982 must have an open collector or solid-state relay output: controllers with option “B,” “C” or “K” selected for output 1 (98_C-__*_-_), output 2 (98_C-__*_-_), output 3 (98_C-__-*_) or output 4 (98_C-__-*_).
- In single-phase applications the controller should be on the same phase as load.
- The time burst is appropriate for fast loads or very tight control. It provides advantages only for PID control, not for ON/OFF control.
- The short time bases used by burst fire makes it incompatible with the heater current feature. The heater current option requires a minimum of 300 milliseconds ON time to get a reading.
- The Series 982 has built in zero-cross detection circuitry, eliminating the need for external firing circuitry to trigger SCR's. The controller will not allow burst fire to be selected if its zero-cross detection circuitry is not functioning.
- The feature is enabled by selecting burst fire **brse** at the cycle time prompt for the appropriate output in the PID Menu — **ct1a**, **ct1b**, **ct2a** or **ct2b**.
- Only the 982 and 981 can use the burst fire feature. The low-voltage units (984 and 983) cannot use burst firing.

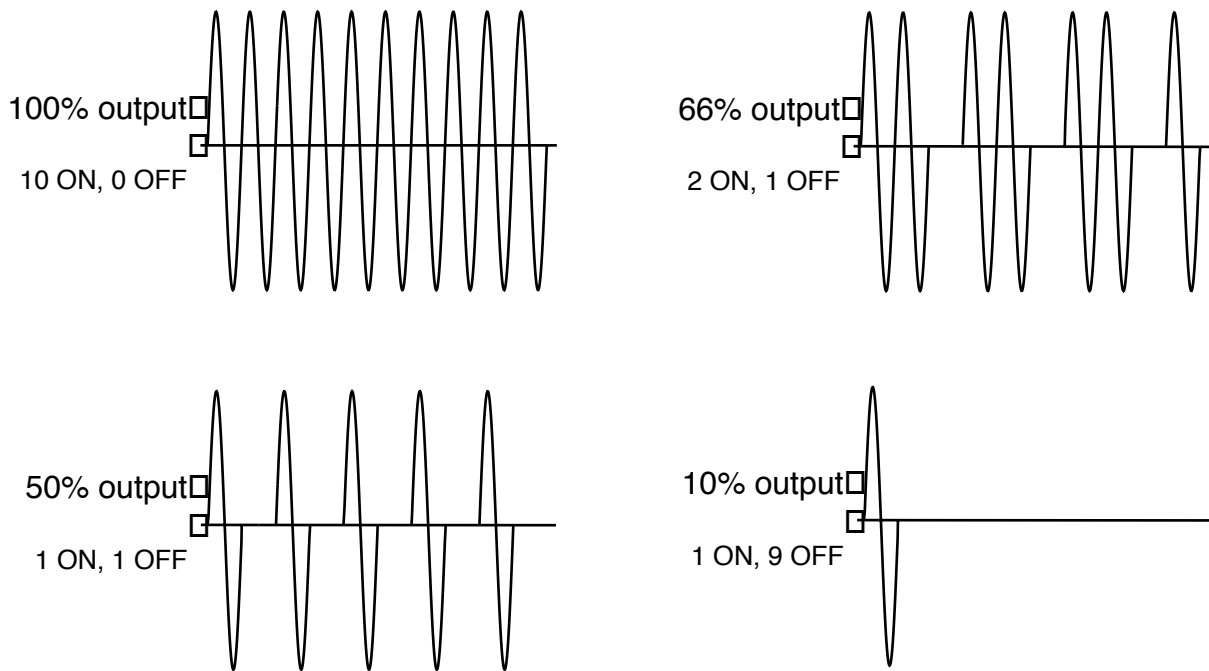

Figure 9.3a - Sine waves of burst fire settings.

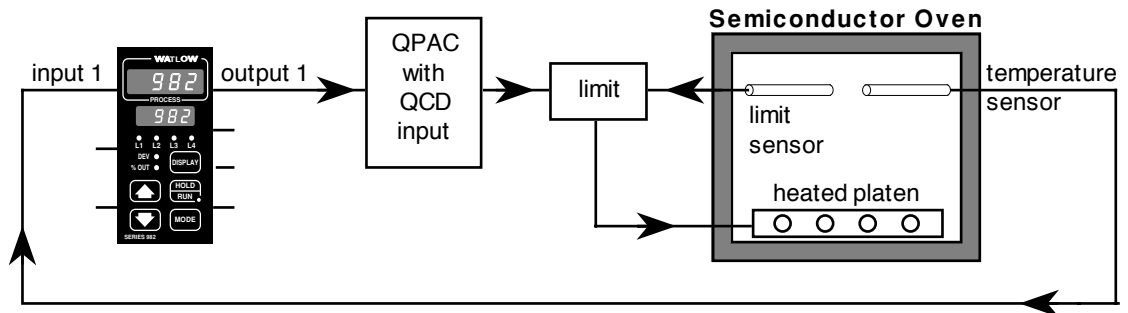

Figure 9.3b - Semiconductor oven with burst fire.

Sample Application

A Series 982 controls a heated platen in a semiconductor oven. Previously it used a power control requiring a 4-20mA signal to implement burst-fire control. We have replaced the power control with a Watlow Loyola QPAC with a QCD card that accepts a signal directly from an open-collector output of the Series 982. This gives smooth control at a lower overall system cost.



Communications

Overview

The serial communications feature allows the Series 982 family to receive commands from and transmit data to a master device, usually a computer. Any function that can be performed via the front panel, can also be accomplished using a serial communications port, allowing you to operate the controller from a computer and to store process data on a computer.

The Series 982 is available with a choice of serial hardware interfaces. An EIA-232 interface allows for one master (computer) and one controller, with a maximum network length of 50 feet (15 meters).

The EIA-485/EIA-422 option equips the controller for a multi-drop interface: up to 32 total network devices with EIA-485 and up to 10 total network devices with EIA-422. Each controller will have its own unique address. The total maximum network length is 4,000 feet (1,219 meters). All interfaces are isolated.

To select between EIA-485 or EIA-422, enter the Setup Menu by holding the up-arrow  and down-arrow  keys simultaneously until setup **SET** appears in the bottom display. Use the up-arrow key to select the Communications Menu **COMM**. At the interface prompt **INTF** select between **422** or **485**.

Other parameters that must be configured in the Communications Menu **COMM** are the baud rate **BAUD**, data bits and parity **DATA**, protocol **Prot**, and device address **Addr**. The protocol prompt must be set to full (ANSI X3.28 2.2-A3) if multiple devices are used with the EIA-485 or EIA-422 interface. If the full protocol is selected, a device address must be selected at the address prompt. For EIA-232, full **FULL** or on **On** (XON/XOFF) protocol may be selected.

Requirements

Choose which interface your application will use: EIA-232 serial communications (98_C-__-R__), or EIA-485/EIA-422 serial communications (98_C-__-S__), or EIA-232/EIA-485 serial communications (98_C-__-U__). The computer must have a compatible serial port or an appropriate converter must be used.

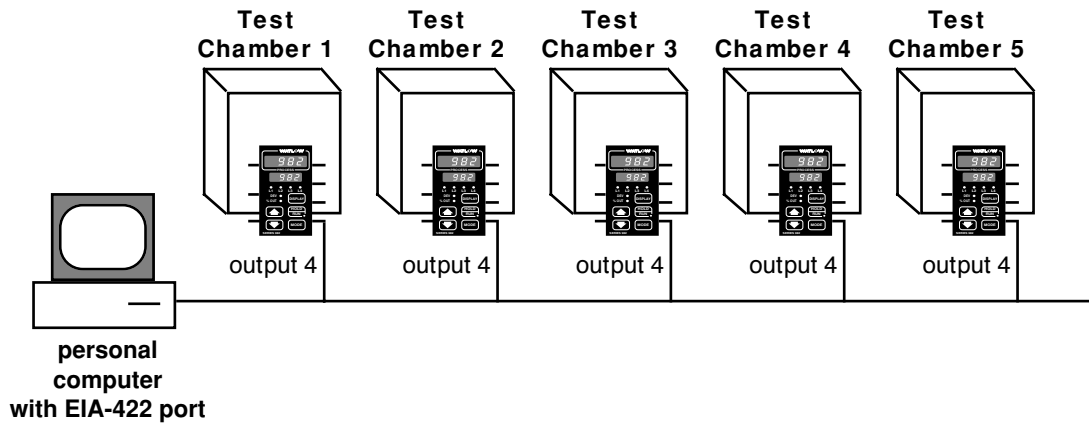

Figure 9.5 - Test chambers with communications.

Sample Application

A test engineer uses Series 982s to control the temperatures of several automated test chambers. His computer is linked to the controllers through its EIA-422 serial communications port. His computer program monitors the temperatures of the chambers and initiates automatic test sequences when certain program parameters are met. After completing a sequence, the computer loads the next temperature profile to the controller. The computer periodically interrogates each controller for its process temperature, set point and alarm status. This information is stored on a disk to provide test verification data for the completed products.

Dead Band

Overview

The dead band prompt, **db**, located in the PID Menu, determine the amount of interaction between heat (reverse acting) and cool (direct acting) control outputs. The dead band directly offsets the target set point of the cool control output.

With a positive dead band, both control outputs will never be ON at the same time. With the process in a positive dead band, the output value is determined by adding the percent heat output to the percent cool output and only applying the result to the correct output — cooling action if the sum is negative and heating action if it is positive.

If the dead band is set to a negative value, the heat and cool outputs can both be ON at the same time.

Requirements

The dead band feature is standard on any Series 982 controller with two control outputs. The dead band prompt will appear if the control outputs are configured for heat/cool or cool/heat.

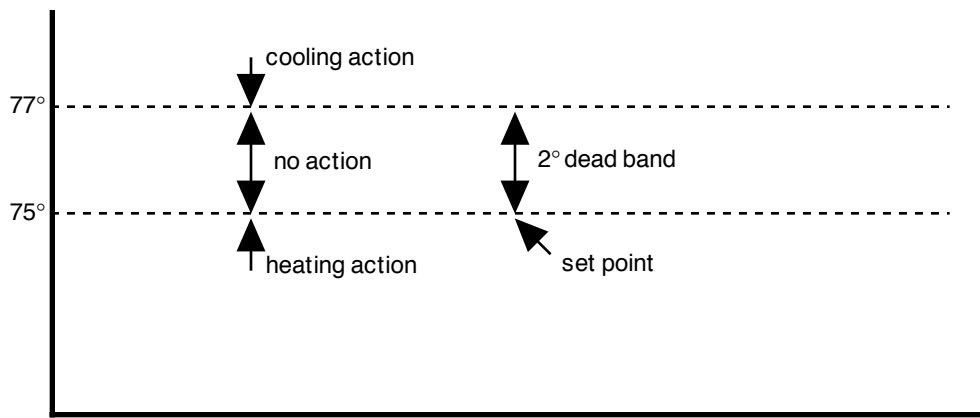

Figure 9.7a - Dead band graph.

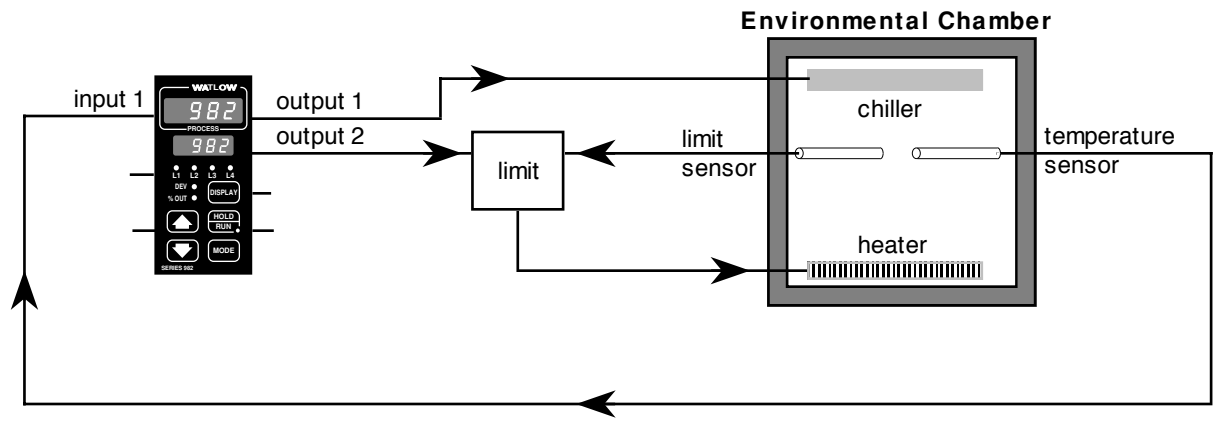

Figure 9.7b - Environmental chamber with dead band.

Sample Application

An engineer for an environmental chamber manufacturer, who is designing the heating and cooling system for a new chamber, wants to minimize the energy costs of operating the chamber. She has chosen the Series 982 and will configure the heat and cool outputs with a positive dead band.

When the chamber temperature is near ambient the cooling and heating systems had a tendency to buck one another, resulting in inefficient use of energy. The engineer started with a dead band of five degrees, but in the process of tuning the system for optimal control, the setting was reduced to two degrees. This made the chamber more energy efficient and reduced wear on the refrigeration system.

Digital Events

Overview

The digital event input options on the Series 982 controller allow the operator to select one of several software functions with the close of a customer-supplied switch or by a change in DC voltage (See Chapter 2 for voltage and wiring information.).

The list below outlines the functions that can be controlled with a digital event input:

- **Front panel lockout** **LOC** locks out the front panel keys to prevent tampering.
- **Alarm reset** **ALR** resets alarms from a remote location.
- **Turn control outputs off** **OFF** inhibits the control outputs, does not hold program.
- **Hold program** **HOLD** ends the program that is currently running and maintains the last set point.
- **Start file 1** **FILE1** starts file 1 from a remote location. It will have no effect if a file is already running.
- **Start file 2** **FILE2** starts file 2 from a remote location. It will have no effect if a file is already running.
- **Start file 3** **FILE3** starts file 3 from a remote location. It will have no effect if a file is already running.
- **Start file 4** **FILE4** starts file 4 from a remote location. It will have no effect if a file is already running.
- **Satisfy a waitfor event input** **WJE** during a soak step.
- **Pause** **PAUS** switches the currently running program to hold mode until the event input opens.
- **Abort** **ABSP** terminates the currently running program and goes to Abort Set Point.

Requirements

A single digital event input is standard on all controls. A second digital input is available as an option for input 2 (98_C-_5_-___).

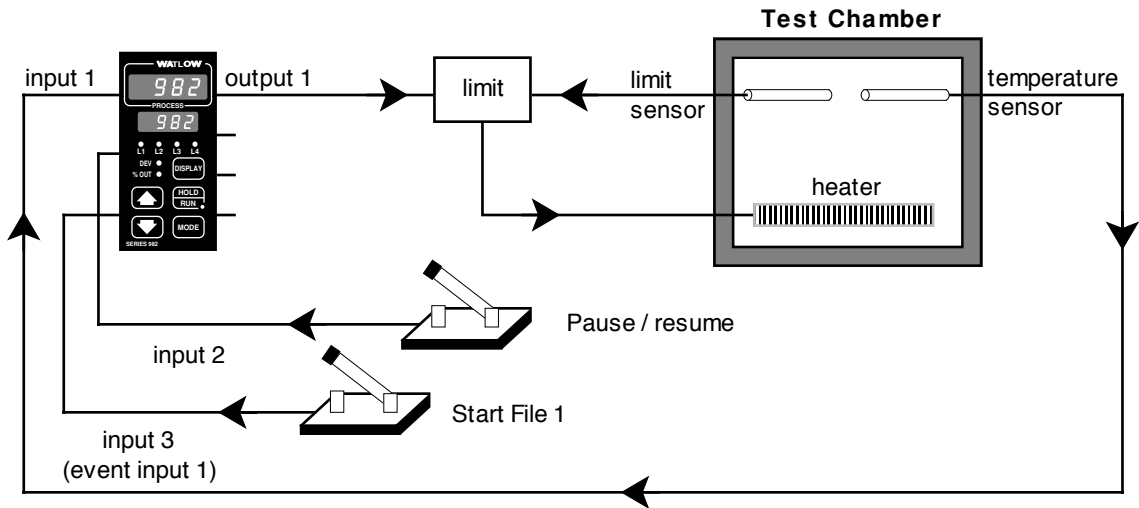

Figure 9.9 - Heater with digital event.

Sample Application

A manufacturing engineer is designing a test chamber that must be very simple for the operator to use. He would like to start the program with minimal operator interaction.

By connecting an external switch to the digital event input, he can configure the Series 982 to start the program in File 1, when the switch momentarily closes. Enable this function by selecting File 1 **FILE 1** for Event Input 1 **E.1.1** (Global Menu). Once the program is started, closing this switch will not have any effect until the program has finished or the program is terminated.

The operator must also have the ability to pause a running program and then resume it again with the same simple interaction.

By ordering the optional second digital event input, another switch can be used to pause the program when the switch is closed and resume running the program when the switch is opened again. Enable this function by selecting pause **PAUSE** for Event input 2 **E.1.2** (Global Menu). This function is only active once a program has been started.

The operator now has the ability to start a program with the press of a button, and pause or resume it with the flip of a switch. The operator never needs to touch the Series 982.

Input Filter

Overview

In certain applications the process being measured can be unstable, which makes it difficult to control and also makes the constantly changing display difficult to read. The Series 982 input filter can solve these problems by smoothing out just the display or the display and the input signal.

You can set a time constant in seconds for a low-pass filter that will, if you select a positive value, affect the display only. Select a negative value to filter the input signal itself. Use this feature with caution, because a large time constant could hide system upsets.

Requirements

This feature is standard on all Series 982 controllers.

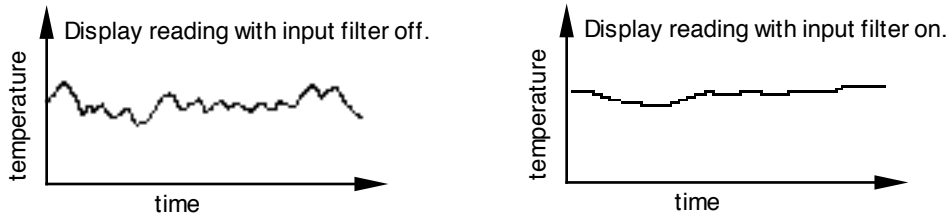

Figure 9.11a - Display readings with input filtering.

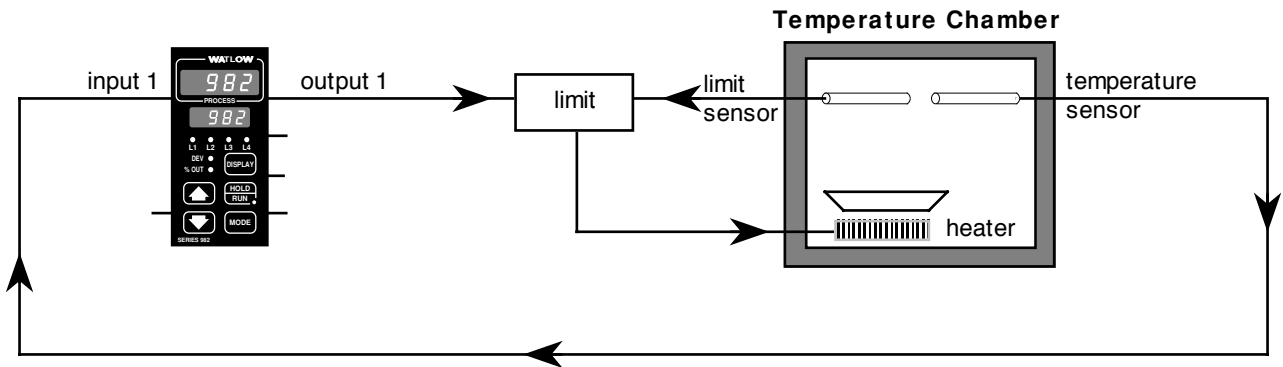

Figure 9.11b - Humidity chamber with input filtering.

Sample Application

A Series 982 controls the temperature in an environmental chamber. The sensor is very sensitive to changes caused by air flow in the chamber. The turbulence in the chamber makes the controller display jump two to three degrees. To remove this display dithering set the filter time constant **FF-1** for input 1 to two seconds. This will smooth the display and provide a more realistic reading.

Retransmit

Overview

The retransmit feature can be used to transmit an analog signal representing the value of either input process variable or the target set point variable. The retransmit signal is factory configured as either a milliamp (98_C-___-M___) or a voltage (98_C-___-N___) signal. In choosing the type of retransmit signal the operator must take into account the input impedance of the device or devices to be retransmitted to and the required signal type, either voltage or milliamps.

Typically applications might use the retransmit option to record one of the variables with a chart recorder or to generate a set point for other controls in a multi-zone application.

Requirements

Output 3 is used for the retransmit option. Choose either a milliamp (98_C-___-M___) or a voltage (98_C-___-N___) signal. Select the output range in the Output Menu.

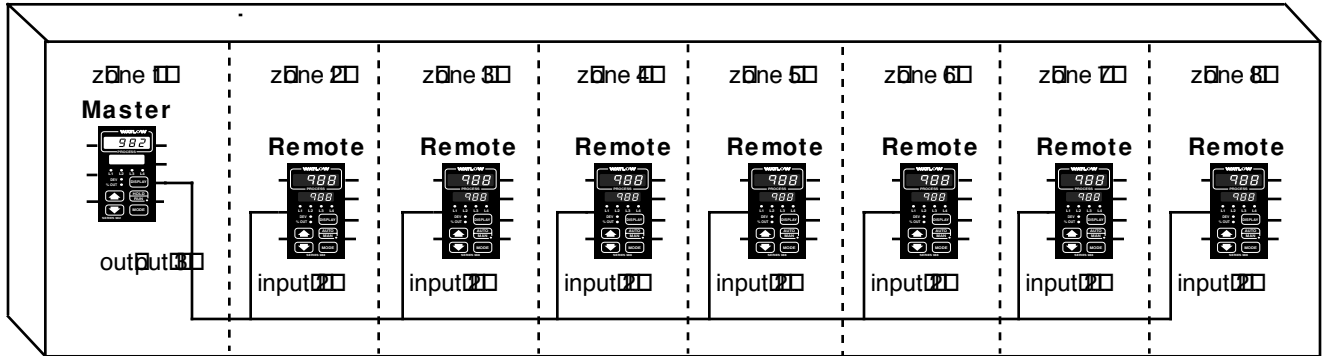

Figure 9.13 - Heat-treat oven with retransmit.

Sample Applications

An engineer needs to control the temperature of individual zones in an eight-zone furnace. The temperatures range from 0°C to 850°C. The process requires the same time/temperature profile for each zone. She wants to do this without using a separate ramping control for each zone.

The Series 982 can be configured with a milliamp retransmit output for output 3, (98_C-___-M___). This controller can control one zone and provide a common 4-20 mA set-point signal for seven Series 988 controllers with remote-set-point capabilities.

Enable the retransmit output by setting **ROUT** to **SETP** (Output Menu). This selects the set point as the retransmit variable. To select the retransmit output range, set **PRC3** to **4-20**. The retransmit output is now 4-20mA. **ARL** and **ARH** determine the scaling for the retransmit output. To make a 4mA signal represent 0°, set **ARL** to **0**. To make a 20mA signal represent 850°, set **ARH** to **850**. A retransmit calibration offset **RCAL** is also available, which applies only to the retransmit output.

The retransmit output will be 4mA until the set point is greater than 0°C and will increase linearly until reaching 20mA, when the set point equals 850°C. The output will not exceed 20mA.

As the Series 982 changes its set point, the 4-20mA retransmit signal follows it, providing the remote set point signal for the seven Series 988 controllers.

The furnace now can provide ramp and soak capabilities for all eight zones, yet reduce system costs and complexity by using a single ramping controller and seven remote-set-point controllers.

Slidewire Feedback

Overview

The Series 982 can control the position of a valve with a slidewire feedback position indicator. The controller senses the resistance of the slidewire and compares it to the range low and range high settings to determine the valve position. The controller compares this to the percent output and takes action to match the two by opening or closing the valve.

Set the hunt **Hunt** parameter to limit valve hunting. The value is set for the percent of output (0.0 to 100.0). When the valve is within this dead band, a change in output greater than half the hunt parameter is required to trigger action. If the valve's momentum causes it to "coast" after the contact opens, try increasing the **SHYS** value. This determines the turn-off point. Output 1 responds to "close" commands and output 2 responds to "open" commands.

Requirements

A slidewire configuration uses at least two inputs and two control outputs. Input 2 must be a slidewire input (98_C-3__-___). Outputs must be compatible with the slidewire valve actuators.

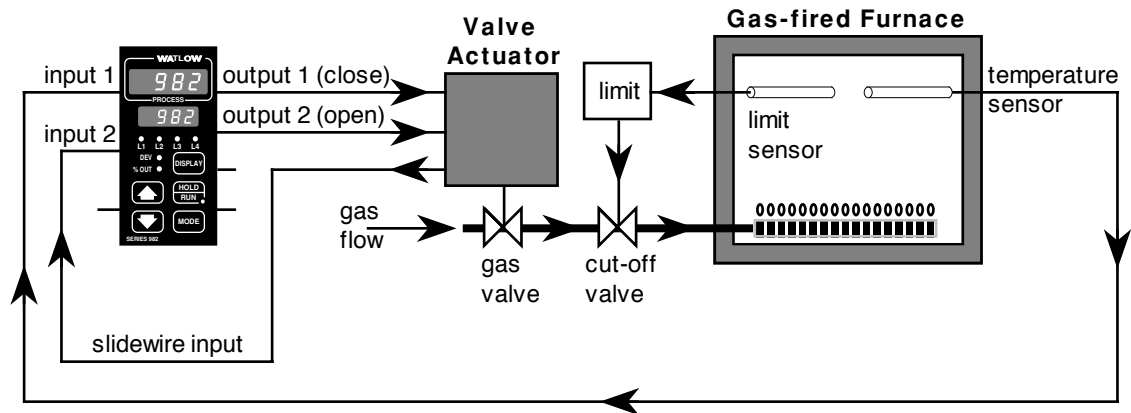

Figure 9.15 - Gas-fired furnace with slidewire feedback.

Sample Application

A Series 982 controls the gas valve for a gas-fired furnace to heat treat large metal parts. First the controller must be “married” to the slidewire feedback from the valve actuator. To do this, first set the Input 2 prompt **In2** to slidewire **SLid**. Advance to the Learn Low Resistance prompt **Lrnl**. Close the valve manually to the minimum resistance reading from the slidewire. Select **YES** in the upper display and press the Mode key **MODE** to advance to the Learn High Resistance prompt **LrnH**. Manually open the valve (maximum slidewire resistance). Select **YES** in the upper display and press the Mode key **MODE**. At this point both the high and low resistance values have been learned and stored in the range low 2 and range high 2 parameters.

NOTE:
See Chapter 4 for more information about Slidewire Hysteresis and Hunt.

You can also manually set the range low and range high values. From the slidewire specifications, determine the low and high resistance values and enter these at the Range Low **rL2** and Range High **rH2** prompts. **rH2** must be greater than **rL2**.

Once the control is operating, adjust the hunt **Hunt** parameter, to minimize valve oscillations. The hunt parameter sets up a dead band on both sides of the current valve position. The desired valve position is then compared to the actual position. If the difference is greater than one-half of the hunt value, the Series 982 repositions the valve to achieve the temperature set point. Once repositioning is complete, the dead band is recalculated for the new valve position. If your valve opens and closes quickly, try increasing the **Hunt** value. If the valve’s momentum causes it to “coast” after the contact opens, try increasing the **SHYS** value.

Notes



Warranty

The Watlow Series 982 is warranted to be free of defects in material and workmanship for 36 months after delivery to the first purchaser for use, providing that the units have not been misapplied. Since Watlow has no control over their use, and sometimes misuse, we cannot guarantee against failure. Watlow's obligations hereunder, at Watlow's option, are limited to replacement, repair or refund of purchase price, and parts which upon examination prove to be defective within the warranty period specified. This warranty does not apply to damage resulting from transportation, alteration, misuse, or abuse.

Watlow Controls

Watlow Controls is a division of Watlow Electric Manufacturing Company, St. Louis, Missouri, a manufacturer of industrial electric heating products, since 1922. Watlow begins with a full set of specifications and completes an industrial product that is manufactured totally in-house, in the U.S.A. Watlow products include electric heaters, sensors, controls and switching devices. The Winona operation has been designing solid state electronic control devices since 1962, and has earned the reputation as an excellent supplier to original equipment manufacturers. These OEMs depend upon Watlow Controls to provide compatibly engineered controls which they can incorporate into their products with confidence. Watlow Controls resides in a 100,000 square foot marketing, engineering and manufacturing facility in Winona, Minnesota.

Returns

1. Call Watlow Customer Service, (507) 454-5300, for a Return Material Authorization (RMA) number before returning any item for repair. We need this information:
 - Ship to address
 - Bill to address
 - Contact name
 - Phone number
 - Ship via
 - Your P.O. number
 - Symptoms and/or special instructions
 - Name and phone number of person returning the material.
2. Prior approval and an RMA number, from the Customer Service Department, is needed when returning any unused product for credit. Make sure the RMA number is on the outside of the carton, and on all paperwork returned. Ship on a Freight Prepaid basis.
3. After we receive your return, we will examine it and determine the cause for your action.
4. In cases of manufacturing defect, we will enter a repair order, replacement order, or issue credit for material. A 20 percent restocking charge is applied for all returned stock controls and accessories.
5. If the unit is unrepairable, it will be returned to you with a letter of explanation. Repair costs will not exceed 50 percent of the original cost.

Shipping Claims

When you receive your Watlow control, examine the package for any signs of external damage it may have sustained enroute. If there is apparent damage either outside the box or to its contents, make a claim with the shipper immediately. Save the original shipping carton and packing material.

Glossary, A-J

annunciator — A visual display that uses pilot lights to indicate the former or existing condition of several items in a system.

burst fire — A power control method that repeatedly turns on and off full ac cycles. Also called zero-cross fire, it switches close to the zero-voltage point of the ac sine wave. Variable-time-base burst fire selectively holds or transits ac cycles to achieve the desired power level. See zero cross.

calibration offset — An adjustment to eliminate the difference between the indicated value and the actual process value.

closed loop — A control system that uses a sensor to measure a process variable and makes decisions based on that feedback.

cold junction — see junction, cold.

cold junction compensation — Electronic means to compensate for the effective temperature at the cold junction.

default parameters — The programmed instructions that are permanently stored in the microprocessor software.

derivative — The rate of change in a process variable. Also known as rate. See PID.

derivative control (D) — The last term in the PID control algorithm. Action that anticipates the rate of change of the process, and compensates to minimize overshoot and undershoot. Derivative control is an instantaneous change of the control output in the same direction as the proportional error. This is caused by a change in the process variable (PV) that decreases over the time of the derivative (TD). The TD is in units of seconds.

Deutsche Industrial Norm (DIN) — A set of technical, scientific and dimensional standards developed in Germany. Many DIN standards have worldwide recognition.

DIN — See Deutsche Industrial Norm.

droop — In proportional controllers, the difference between set point and actual value after the system stabilizes.

duty cycle — The percentage of a cycle time in which the output is on.

external transmitter power supply — A dc voltage source that powers external devices.

filter, digital (DF) — A filter that slows the response of a system when inputs change unrealistically or too fast. Equivalent to a standard resistor-capacitor (RC) filter.

form A — A single-pole, single-throw relay that uses only the normally open (NO) and common contacts. These contacts close when the relay coil is energized. They open when power is removed from the coil.

form B — A single-pole, single-throw relay that uses only the normally closed (NC) and common contacts. These contacts open when the relay coil is energized. They close when power is removed from the coil.

form C — A single-pole, double-throw relay that uses the normally open (NO), normally closed (NC) and common contacts. The operator can choose to wire for a form A or form B contact.

hysteresis — A change in the process variable required to re-energize the control or alarm output. Sometimes called switching differential.

integral — Control action that automatically eliminates offset, or droop, between set point and actual process temperature. See auto-reset.

integral control (I) — A form of temperature control. The I of PID. See integral.

isolation — Electrical separation of sensor from high voltage circuitry. Allows use of grounded or ungrounded sensing element.

JIS — Joint Industrial Standards (JIS) A Japanese agency that establishes and maintains standards for equipment and components. Also known as JISC (Japanese Industrial Standards Committee), its function is similar to Germany's Deutsche Industrial Norm (DIN).

junction, cold — Connection point between thermocouple metals and the electronic instrument. See junction, reference.

junction, reference — The junction in a thermocouple circuit held at a stable, known temperature (cold junction). Standard reference temperature is 32°F (0°C).

NEMA 4X — A NEMA specification for determining resistance to moisture infiltration. This rating certifies the controller as washable and corrosion resistant.

on/off controller — A temperature controller that operates in either full on or full off modes.

open loop — A control system with no sensory feedback.

output — Control signal action in response to the difference between set point and process variable.

overshoot — The amount by which a process variable exceeds the set point before it stabilizes.

P control — Proportioning control.

PD control — Proportioning control with derivative (rate) action.

PDR control — Proportional derivative control with manual reset, used in fast responding systems where the reset causes instabilities. With PDR control, an operator can enter a manual reset value that eliminates droop in the system.

PI control — Proportioning control with integral (auto-reset) action.

PID — Proportional, integral, derivative. A control mode with three functions: proportional action dampens the system response, integral corrects for droop, and derivative prevents overshoot and undershoot.

proportional — Output effort proportional to the error from set point. For example, if the proportional band is 20° and the process is 10° below set point, the heat proportioned effort is 50 percent. The lower the PB value, the higher the gain.

proportional band (PB) — A range in which the proportioning function of the control is active. Expressed in units, degrees or percent of span. See PID.

proportional control — A control using only the P (proportional) value of PID control.

range — The area between two limits in which a quantity or value is measured. It is usually described in terms of lower and upper limits.

rate — Anticipatory action that is based on the rate of temperature change, and compensates to minimize overshoot and undershoot. See derivative.

rate band — A range in which the rate function of a controller is active. Expressed in multiples of the proportional band. See PID.

reference junction — see junction, reference.

remote — A controller that receives its set point signal from another device called the master.

remote set point — A signal that indicates the set point for the process, and is sent from another device.

reset — Control action that automatically eliminates offset, or droop, between set point and actual process temperature. Also see integral.

automatic reset — The integral function of a PI or PID temperature controller that adjusts the process temperature to the set point after the system stabilizes. The inverse of integral.

automatic power reset — A feature in latching limit controls that does not recognize power outage as a limit condition. When power is restored, the output is re-energized automatically, as long as the temperature is within limits.

manual reset — 1) A feature on a limit control that requires human intervention to return the limit to normal operation after a limit condition has occurred. 2) The adjustment of a proportional control to raise the proportional band to compensate for droop.

Glossary, R-Z

resistance temperature detector (RTD) — A sensor that uses the resistance temperature characteristic to measure temperature. There are two basic types of RTDs: the wire RTD, which is usually made of platinum, and the thermistor, which is made of a semiconductor material. The wire RTD is a positive temperature coefficient sensor only, while the thermistor can have either a negative or positive temperature coefficient.

RTD — See resistance temperature detector.

thermal system — A regulated environment that consists of a heat source, heat transfer medium or load, sensing device and a control instrument.

thermocouple (t/c) — A temperature sensing device made by joining two dissimilar metals. This junction produces an electrical voltage in proportion to the difference in temperature between the hot junction (sensing junction) and the lead wire connection to the instrument (cold junction).

thermocouple break protection — The ability of a control to detect a break in the thermocouple circuit and take a predetermined action.

three-mode control — Proportioning control with integral (reset) and derivative (rate). Also see PID.

time proportioning control — A method of controlling power by varying the on/off duty cycle of an output. This variance is proportional to the difference between the set point and the actual process temperature.

transmitter — A device that transmits temperature data from either a thermocouple or a resistance temperature detector (RTD) by way of a two-wire loop. The loop has an external power supply. The transmitter acts as a variable resistor with respect to its input signal. Transmitters are desirable when long lead or extension wires produce unacceptable signal degradation.

zero cross — Action that provides output switching only at or near the zero-voltage crossing points of the ac sine wave. See burst fire.

zero switching — See zero cross.

% out LED 3.1

A

A/D overflow error 8.6
 A/D underflow error 8.5
 abort set point 4.31
 actions, error code 8.6
 address 4.40
 alarm 2 4.17
 alarm 2 high 5.5
 alarm 2 low 5.5
 alarm 3 4.19
 alarm 3 high 5.6
 alarm 3 low 5.6
 alarm 4 4.22
 alarm 4 high 5.7
 alarm 4 low 5.7
 alarms 8.4 - 8.5
 alarm silencing 8.5
 ambient error 8.6
 ambient temperature 6.4
 analog output 4.25
 annunciator 4.32
 auto-tune 5.8
 auto-tune set point 4.33
 auto-tuning 8.1 - 8.2

B

battery backup DIP 1.4
 baud rate 4.39
 burst fire 9.2 - 9.3

C

Calibration Menu 6.7 - 6.8
 calibration offset 1 4.6
 calibration offset 2 4.10
 celsius-fahrenheit 4.29
 communications 9.4 - 9.5
 Communications Menu 4.38 - 4.42
 configuration error 8.6
 cycle time, output 1 5.14
 cycle time, output 2 5.17

D

data bits and parity 4.39
 date 6.3
 dead band 5.17, 9.6 - 9.7
 decimal 1 4.4
 Declaration of Conformity A.10
 default 6.8
 derivative, output 1 5.13
 derivative, output 2 5.16
 deviation alarm 8.4
 dev LED 3.1
 Diagnostics Menu 6.2 - 6.6
 digital event input 1 2.10
 digital event input 2 2.9
 digital events 9.8 - 9.9

DIP switch

external power supply 1.5
 hardware lock/battery backup 1.4
 locations and functions 1.3
 universal signal input type 1.6
 display loop 3.2
 display key 3.1
 display tests 6.6
 down key 3.1

E

editing a profile 7.10 - 7.11
 end 7.4
 end step 7.4
 environmental chamber 9.7
 error codes 8.5 - 8.6
 error latching 4.29
 event 3
 set point step 7.2
 soak step 7.3
 event 4
 set point step 7.2
 soak step 7.3
 event input 1 4.30
 event input 1 status 5.3
 event input 1 wiring 2.10
 event input 2 4.31
 event input 2 status 5.3
 event output 3 status 5.4
 event output 4 status 5.4
 event outputs 7.6 - 7.7
 external power supply DIPs 1.5

F

Factory Menus 6.1 - 6.8
 file 7.1
 front panel 3.1

G

gas-fired furnace 9.15
 Global Menu 4.28 - 4.37
 guaranteed soak deviation 4.34, 7.7

H

hardware lockout DIP switch 1.4
 heater with digital event 9.9
 heat-treat oven 9.15
 high power limit 4.33
 hold/run key 3.1
 hold/run LED 3.1
 hour 7.3
 humidity chamber 9.11
 hunt 4.10
 hysteresis 1 4.14
 hysteresis 2 4.16
 hysteresis 3 4.20
 hysteresis 4 4.23

I

idle set point 4.36
 input 1 4.3
 input 1 wiring 2.8
 input 1, digital event 2.10
 input 2 4.8
 input 2 wiring 2.9
 input 2, digital event 2.9
 input DIP switches 1.6
 input filter 9.10 - 9.11
 Input Menu 4.2 - 4.11
 input module types 6.4
 input/output isolation 2.4
 installation procedure 2.1 - 2.3
 integral, output 1 5.12
 integral, output 2 5.15
 interface type 4.41

J

jump count 7.4
 jump file 7.4
 jump-loop 7.8
 jump-loop step 7.4
 jump step 7.4

L

L1... L4 3.1
 latching 2 4.17
 latching 3 4.21
 latching 4 4.24
 learn high range 4.9
 learn low range 4.9
 link file 7.4
 linking profiles 7.12
 lockout 4.37
 lower display 3.1
 low power limit 4.32

M

manual tuning 8.2 - 8.3
 master step chart 7.14
 menu overview 1.2
 messages, error code 8.5
 minutes 7.2, 7.3
 mode key 3.1

N

non-volatile checksum error 8.6

O

Operation Menu 5.1 - 5.18
 output 1 4.13
 output 1 wiring 2.11
 output 2 4.15
 output 2 wiring 2.12

Index

output 3 4.18
output 3 jumper, changing 8.3
output 3 wiring 2.13
output 4 4.22
output 4 wiring 2.14
Output Menu 4.12 - 4.27
output module types 6.5
output test 6.6

P

PID Menu 5.10 - 5.18
power outage 4.35
power wiring 2.4
process 1 4.14
process 2 4.15
process 3 4.25
process alarm 8.4
profile, editing 7.10
profile, resuming 7.5
profile, running 7.5, 7.10
profiles, linking 7.12
profile start 4.36
Program Menu 7.1 - 7.4
program a ramping profile 7.8 - 7.9
programming 7.1 - 7.4
program prompts 7.1
program type 4.34
proportional band, output 1 5.11
proportional band, output 2 5.14
protocol type 4.40

R

ramp and soak profile 7.9
ramping, set point 3.2
ramping profile, program 7.8 - 7.9
ramp/soak with jump-loop 7.11
RAM verification error 8.6
range high 1 4.5
range low 1 4.5
range high 2 4.9
range low 2 4.8
rate 7.2
rate alarm 8.5
rate, output 1 5.13
rate, output 2 5.16
Re-run Menus 7.6
reset, output 1 5.12
reset, output 2 5.15
restore 6.8
resume a profile 7.5
retransmit 9.12 - 9.13
retransmit calibration offset 4.27
retransmit high limit 4.26

retransmit low limit 4.26
RTD 1 4.7
RTD, 2 or 3 wire 2.8
Run Menus 7.5 - 7.6
running a profile 7.5, 7.10

S

safety information ii
seconds 7.2, 7.3
semiconductor oven, burst fire 9.3
sensor installation 2.4
sensor overrange error 8.6
sensor underrange error 8.5
serial number 6.3
set point 3.2, 7.2
set point step 7.2
Setup Menus 4.1 - 4.42
silencing 2 4.18
silencing 3 4.21
silencing 4 4.24
slidewire feedback 9.14 - 9.15
slidewire feedback input 2.9
slidewire hysteresis 4.11
soak 7.3
soak step 7.8, 7.13
software filter 1 4.7
software revision 6.3
step 7.1
step type 7.2
System Menu 5.2 - 5.9

T

technical assistance ii
test chambers 9.5
test displays 6.6
test outputs 6.6
thermocouple or 0-50 mV 2.8

U

universal signal input type DIP
switches 1.6
up key 3.1
upper display 3.1

W

waitfor event input 7.3
waitfor functions 7.13
waitfor process crossover value 7.3
wastewater treatment 9.13
wiring 2.4 - 2.14
wiring 0-20mA and 4-20mA process
inputs 2.5
wiring example 2.6
wiring notes 2.7

A

A_{SO} 6.7
Addr address 4.40
A2H1 alarm 2 high 5.5
A2LO alarm 2 low 5.5
A3H1 alarm 3 high 5.6
A3LO alarm 3 low 5.6
A4H1 alarm 4 high 5.7
A4LO alarm 4 low 5.7
AbSP abort set point 4.31
ACAL retransmit calibration offset 4.27
AL2 alarm 2 4.17
AL3 alarm 3 4.19
AL4 alarm 4 4.22
AP7b ambient temperature 6.4
Anun annunciator 4.32
Aout analog output 4.25
ArH retransmit high limit 4.26
ArL retransmit low limit 4.26
AtSP auto-tune set point 4.33
AUT auto-tune 5.8

B

bAUD baud rate 4.39
brSt burst fire 9.2

C

C_F celsius-fahrenheit 4.29
CAL1 calibration offset 1 4.6
CAL2 calibration offset 2 4.10
Ct1 cycle time, output 1 5.14
Ct2 cycle time, output 2 5.17

D

DATA data bits and parity 4.39
DATE date 6.3
db dead band 5.17
dE1 derivative, output 1 5.13
dE2 derivative, output 2 5.16
DEC1 decimal 1 4.4
dFL default 6.8
dISP test displays 6.6

E

E₁ event input 1 4.30
E_{1S} event input 1 status 5.3
E₂ event input 2 4.31
E_{2S} event input 2 status 5.3
End end step (end) 7.4
EnE3 event 3 7.2, 7.3
EnE3 event output 3 status 5.4
EnE4 event 4 7.2, 7.3
EnE4 event output 4 status 5.4
Err error latching 4.29

F

FILE file 7.1
FtF1 software filter 1 4.7

G

GSD guaranteed soak deviation 4.34

H

HiP high power limit 4.33
Hour hour 7.2, 7.3
Hunt hunt 4.10
HYS1 hysteresis 1 4.14
HYS2 hysteresis 2 4.16
HYS3 hysteresis 3 4.20
HYS4 hysteresis 4 4.23

I

IdSP idle set point 4.36
In1 input 1 4.3
In2 input 2 4.8
I_{E1} integral, output 1 5.12
I_{E2} integral, output 2 5.15
iEY1 input 1 module type 6.4
iEY2 input 2 module type 6.4
IntF interface type 4.41

J

JC jump count 7.4
JF jump file 7.4
JL jump-loop step 7.4
JS jump step 7.4

L

LAb2 latching 2 4.17
LAb3 latching 3 4.21
LAb4 latching 4 4.24
LFIL link file 7.4
LOC lockout 4.37
LoP low power limit 4.32
LrnH learn high range 4.9
LrnL learn low range 4.9

M

M_{in} minutes 7.2, 7.3

O

OE1 output 1 4.13
OE2 output 2 4.15
OE3 output 3 4.18
OE4 output 4 4.22
OEY1 output 1 module type 6.5

OEY2 output 2 module type 6.5
OEY3 output 3 module type 6.5
OEY4 output 4 module type 6.5

P

PAUS pause 9.8
Pb1 proportional band, output 1 5.11
Pb2 proportional band, output 2 5.14
POut power outage 4.35
PrC1 process 1 4.14
PrC2 process 2 4.15
PrC3 process 3 4.25
PStF profile start 4.36
PEYP program type 4.34
Prot protocol type 4.40

R

rA1 rate, output 1 5.13
rA2 rate, output 2 5.16
rATE rate 7.2
rE1 reset, output 1 5.12
rE2 reset, output 2 5.15
rH1 range high 1 4.5
rH2 range high 2 4.9
rL1 range low 1 4.5
rL2 range low 2 4.8
rSt restore 6.8
rtD1 RTD 1 4.7

S

SEC seconds 7.2, 7.3
SHYS slidewire hysteresis 4.11
SIL2 silencing 2 4.18
SIL3 silencing 3 4.21
SIL4 silencing 4 4.24
SoRH soak 7.3
SOFE software revision 6.3
S_n serial number 6.3
SP set point 7.2
STEP step 7.1
STEP set point step 7.2
SEYP step type 7.2

T

tOut test outputs 6.6

W

WJE waitfor event input 7.3
WJPr waitfor process crossover value 7.3

Specifications

Specifications (1306)

Control Mode

- Single input, quad output, optional retransmit of set point or process variable.
- Programmable direct- and reverse-acting control outputs.
- 4-file, 6 steps per file, time/temperature profile or fixed-set-point control.
- Ramp-rate or time-based programming.
- Selectable control status following power loss.

Agency Approvals

- CE: 89/336/EEC Electromagnetic Compatibility Directive.
EN 50081-2: 1994 Emissions.
EN 50082-2: 1994 Immunity.
- 73/23/EEC Low Voltage Directive.
EN 61010-1: 1993 Safety.
- UL #873, C-UL File #E43684
- NEMA 4X

Operator Interface

- Dual, four digit LED displays.
Upper: 0.4 inch (10 mm).
Lower: 0.3 inch (8 mm).
- Mode, Hold/Run, Display, Up and Down keys.

Accuracy

- Calibration accuracy and sensor conformity: $\pm 0.1\%$ of span, ± 1 LSD, $77^\circ\text{F} \pm 5^\circ\text{F}$ ($25^\circ\text{C} \pm 3^\circ\text{C}$) ambient and rated line voltage $\pm 10\%$.
- Accuracy span: 1000°F (540°C) minimum.
- Temperature stability: $\pm 0.2^\circ\text{F}/^\circ\text{F}$ ($0.1^\circ\text{C}/^\circ\text{C}$) change in ambient.

Sensors/Inputs

- Contact input for software function select (event input).
- Thermocouple Types B, C², D², E, J, K, N, R, S, T and Pt 2².
- RTD resolution in 1° or 0.1° RTD scales.
- Process variables: 0-20mA, 4-20mA, 0-5V_{rms} (dc), 1-5V_{rms} (dc), and 0-10V_{rms} (dc).
- Slidewire or digital event input options.
- Sensor break protection de-energizes system for safety. Latching or non-latching.

Input Range

Specified temperature ranges represent the controller's operational span.

• Thermocouple

Available with basic or universal signal conditioner

Type C ²	32 to 4200°F	(0 to 2316°C)
Type D ²	32 to 4200°F	(0 to 2316°C)
Type E	-328 to 1470°F	(-200 to 799°C)
Type J	32 to 1500°F	(0 to 816°C)
Type K	-328 to 2500°F	(-200 to 1371°C)
Type N	32 to 2372°F	(0 to 1300°C)
Type T	-328 to 750°F	(-200 to 399°C)
Pt 2 ²	32 to 2543°F	(0 to 1395°C)

Available with universal signal conditioner

Type B	1598 to 3300°F	(870 to 1816°C)
Type R	32 to 3200°F	(0 to 1760°C)
Type S	32 to 3200°F	(0 to 1760°C)

• RTD Resolution (DIN or JIS)

1° (DIN)	-328 to 1472°F	(-200 to 800°C)
1° (JIS)	-328 to 1166°F	(-200 to 630°C)
0.1° (DIN and JIS)		

-99.9 to 999.9°F (-73.3 to 537.7°C)

• Process

-999 to 9999 units for all: 0-5V_{rms} (dc); 1-5V_{rms} (dc); 0-10V_{rms} (dc); 0-20mA; and 4-20mA.

• Input 2 slidewire feedback

100 to 1200Ω.

Output Options

- Solid-state relay, Form A, 0.5A @ 24V~ (ac) min., 253V~ (ac) max., opto-isolated, burst fire switching. With or without contact suppression. Off-state output impedance is 20kΩ with RC suppression, 31MΩ without contact suppression.
- Open collector or switched dc signal provides a minimum turn-on voltage of 3V_{rms} (dc) into a minimum 500Ω load; maximum on voltage not greater than 32V_{rms} (dc) into an infinite load, isolated.
- Electromechanical relay², Form C, 5A @ 120/240V~ (ac), 6A @ 28V_{rms} (dc), 1/8 hp. @ 120V~ (ac), 125VA @ 120V~ (ac). With or without contact suppression. Off-state output impedance with RC suppression is 20kΩ.
- Process, 0-20mA, 4-20mA into 800Ω maximum, 0-5V_{rms} (dc), 1-5V_{rms} (dc) or 0-10V_{rms} (dc) into 1kΩ minimum reverse acting, isolated.
- Electromechanical relay², Form A/B, 5A @ 120/240V~ (ac), 6A @ 28V_{rms} (dc), 1/8 hp. @ 120V~ (ac), 125VA @ 120V~ (ac). Without contact suppression.
- External transmitter power supply, 5, 12 or 20V_{rms} (dc) @ 30mA.
- EIA/TIA-232 communications or EIA/TIA-485, EIA/TIA-422 communications, opto-isolated.
- Retransmit: 0-20mA, 4-20mA with 600Ω max. load impedance, or 0-5V_{rms} (dc), 1-5V_{rms} (dc) and 0-10V_{rms} (dc) with 500Ω min. load impedance.

Line Voltage/Power

- 100-240V_{rms}(ac/dc) +10%, -15%; 50/60Hz, $\pm 5\%$.
- 24 to 28V_{rms}(ac/dc) +10%, -15%; 50/60Hz, $\pm 5\%$.
- Fused internally (factory replaceable only) Slo-Blo® type (time-lag): 2A, 250V for high voltage versions; 5A, 250V for low voltage versions.
- Power consumption 16VA maximum.
- Non-volatile memory retains data if power fails.

Operating Environment

- 32 to 130°F (0 to 55°C).
- 0 to 90% RH, non-condensing.

Storage Temperature

- -40 to 185°F (-40 to 85°C).

Terminals

- #6 compression universal head screws, accepts 28-14 gauge wire.

Controller Weight

- 1.0 lb (0.45 kg).

Shipping Weight

- 3.01 lbs (1.35 kg).

Sample/Update Rates

- 1 input: 10Hz.
- 2 inputs: 5Hz.
- Retransmit: 1Hz.
- Remote set point: 1Hz.
- PID: 10Hz.
- Control outputs: 10Hz.
- Alarm outputs: 1Hz.
- Display: 2Hz.

Resolution

- Inputs: 16 bits.

To order, complete the code number with the information below:

Series 981/982 9 8 C - - - - -

Power Supply & Mounting _____

1 = 100 to 240V \approx (ac/dc) nominal, horizontal mounting
 2 = 100 to 240V \approx (ac/dc) nominal, vertical mounting
 3 = 24 to 28V \approx (ac/dc) nominal, horizontal mounting
 4 = 24 to 28V \approx (ac/dc) nominal, vertical mounting

Software _____

C = Standard (4-file, 6 step per file, program capability)

Input 1 _____

1 = Basic thermocouple signal conditioner (excluding Type B, R, and S)
 2 = Universal signal conditioner (see input range information)

Input 2 _____

0 = None
 3 = Slidewire feedback (see range information)
 5 = Second digital event (one digital event is standard on all units)

Output 1 _____

B = Solid-state relay, Form A, 0.5A, with RC suppression
 C = Switched dc or open collector, isolated
 D = Electromechanical relay¹, Form C, 5A with RC suppression
 E = Electromechanical relay¹, Form C, 5A without contact suppression
 F = Universal process, 0-5V \approx (dc), 1-5V \approx (dc), 0-10V \approx (dc),
 0-20mA \approx (dc), 4-20mA \approx (dc), isolated
 K = Solid-state relay, Form A, 0.5A, without contact suppression

Output 2 _____

A = None
 B = Solid-state relay, Form A, 0.5A, with RC suppression
 C = Switched dc or open collector, isolated
 D = Electromechanical relay¹, Form C, 5A with RC suppression
 E = Electromechanical relay¹, Form C, 5A without contact suppression
 F = Universal process 0-5V \approx (dc), 1-5V \approx (dc), 0-10V \approx (dc),
 0-20mA \approx (dc), 4-20mA \approx (dc), isolated
 K = Solid-state relay, Form A, 0.5A, without contact suppression
 T = External signal conditioner power supply, 5, 12 or 20V \approx (dc) @ 30mA

Output 3 _____

A = None
 B = Solid-state relay, Form A, 0.5A, with RC suppression
 C = Switched dc, isolated
 J = Electromechanical relay¹, Form A or B, 5A without contact suppression
 K = Solid-state relay, Form A, 0.5A without contact suppression
 M = Retransmit, 0-20mA \approx (dc), 4-20mA \approx (dc)
 N = Retransmit, 0-5V \approx (dc), 1-5V \approx (dc), 0-10V \approx (dc)
 T = External signal conditioner power supply, 5, 12 or 20V \approx (dc) @ 30mA

Output 4 _____

A = None
 B = Solid-state relay, Form A, 0.5A, with RC suppression
 C = Switched dc or open collector, isolated
 D = Electromechanical relay¹, Form C, 5A with RC suppression
 E = Electromechanical relay¹, Form C, 5A without contact suppression
 K = Solid-state relay, Form A, 0.5A without contact suppression
 R = EIA/TIA-232 communications, opto-isolated
 S = EIA/TIA-485, EIA/TIA-422 communications, opto-isolated
 T = External signal conditioner power supply, 5, 12 or 20V \approx (dc) @ 30mA
 U = EIA/TIA-232 or EIA/TIA 485, opto-isolated

Display Color (Upper/Lower) _____

GG = Green/Green	RG = Red/Green
GR = Green/Red	RR = Red/Red

¹ Electromechanical relays warranted for 100,000 closures only. Solid-state switching devices recommended for applications requiring fast cycle times or extended service life.
² Not an ANSI symbol.

UL[®] is a registered trademark of the Underwriters Laboratories, Inc.
 Slo-Blo[®] is a registered trademark of Littelfuse, Inc.

NOTE: User documentation may be available in French, German, Spanish, Italian and Dutch, as well as English. Check Watlow's website (www.watlow.com/) for availability. Specify language at time of order.

Declaration of Conformity

Series 981, 982, 983, 984

WATLOW CONTROLS

1241 Bundy Boulevard

Winona, Minnesota 55987 USA

CE 96

Declares that the following product:

English

Designation: Series 981, 982, 983, 984
Model Number(s): 9 8 (1 2 3 or 4) (Any letter) - (1 or 2) (0 3 or 5) (B C D E F or K) (A B C D E F K or T) - (A B C J K M N or T) (A B C D E K R S or T) (Any two letters)
Classification: Control, Installation Category II, Pollution Degree II
Rated Voltage: 100 to 240V~ or 24 to 28V
Rated Frequency: 50/60 Hz
Rated Power Consumption: 16VA maximum

Meets the essential requirements of the following European Union Directive(s) using the relevant section(s) of the normalized standards and related documents shown:

89/336/EEC Electromagnetic Compatibility Directive

EN 50082-2: 1995 EMC Generic immunity standard, Part 2: Industrial environment

EN 61000-4-2: 1995 Electrostatic discharge

EN 61000-4-4: 1995 Electrical fast transients

EN 61000-4-3: 1996 Radiated immunity

EN 61000-4-6: 1996 Conducted immunity

ENV 50204: 1995 Cellular phone

EN 50081-2: 1994 EMC generic emission standard, Part 2: Industrial environment

EN 55011: 1991 Limits and methods of measurement of radio disturbance characteristics of industrial, scientific and medical radio-frequency equipment (Group 1, Class A)

EN 61000-3-2: 1995 Limits for harmonic current emissions

EN 61000-3-3: 1995 Limitations of voltage fluctuations and flicker

73/23/EEC Low-Voltage Directive

EN 61010-1: 1993 Safety requirements for electrical equipment for measurement, control, and laboratory use, Part 1: General requirements

Déclare que le produit suivant :

Français

Désignation : Série 981, 982, 983, 984
Numéro(s) de modèle(s) : 9 8 (1 2 3 ou 4) (lettre quelconque) - (1 ou 2) - (0 3 ou 5) (B C D E F ou K) (A B C D E F K ou T) - (A B C J K M N ou T) (A B C D E K R S ou T) (deux lettres quelconques)

Classification : Commande, installation catégorie II, degré de pollution II

Tension nominale : 100 à 240 V~ ou 24 à 28 V

Fréquence nominale : 50/60 Hz

Consommation

d'alimentation nominale : 16 VA maximum

Conforme aux exigences de la (ou des) directive(s) suivantes de l'Union Européenne figurant aux sections correspondantes des normes et documents associés ci-dessous :

89/336/EEC Directive de compatibilité électromagnétique

EN 50082-2 : 1995 Norme générique d'insensibilité électromagnétique, Partie 2 : Environnement industriel

EN 61000-4-2 : 1995 Décharge électrostatique

EN 61000-4-4 : 1995 Courants électriques transitoires rapides

EN 61000-4-3 : 1996 Insensibilité à l'énergie rayonnée

EN 61000-4-6 : 1996 Insensibilité à l'énergie par conduction

ENV 50204 : 1995 Téléphone cellulaire

EN 50081-2 : 1994 Norme générique sur les émissions électromagnétiques, Partie 2 : Environnement industriel

EN 55011 : 1991 Limites et méthodes de mesure des caractéristiques d'interférences du matériel radiofréquence industriel, scientifique et médical (Groupe 1, Classe A)

EN 61000-3-2 : 1995 Limites d'émission d'harmoniques

EN 61000-3-3 : 1995 Limitations d'écart de tension et de papillotement

73/23/EEC Directive liée aux basses tensions

EN 61010-1 : 1993 Exigences de sécurité pour le matériel électrique de mesure, commande et de laboratoire, Partie 1 : Exigences générales

Erklärt, daß das folgende Produkt:

Deutsch

Beschreibung: Serie 981, 982, 983, 984
Modellnummer(n): 9 8 (1 2 3 oder 4) (beliebiger Buchstabe) - (1 oder 2) (0 3 oder 5) (B C D E F oder K) (A B C D E F K oder T) - (A B C J K M N oder T) (A B C D E K R S oder T) (2 beliebige Buchstaben)

Klassifikation: Regelsystem, Installationskategorie II, Emissionsgrad II

Nennspannung: 100 bis 240 V~ oder 24 bis 28 V

Nennfrequenz: 50/60 Hz

Stromverbrauch: Max. 16 VA

Erfüllt die wichtigsten Normen der folgenden Anweisung(en) der Europäischen Union unter Verwendung der untenstehenden einschlägigen Dokumente:

89/336/EEC Elektromagnetische Übereinstimmungsanweisung

EN 50082-2: 1995 EMC-Rahmennorm für Störsicherheit, Teil 2: Industrielle Umwelt

EN 61000-4-2: 1995 Elektrostatische Entladung

EN 61000-4-4: 1995 Elektrische schnelle Stöße

EN 61000-4-3: 1996 Strahlungsimmunität

EN 61000-4-6: 1996 Leitungsimmunität

ENV 50204: 1995 Mobiltelefon

EN 50081-2: 1994 EMC-Rahmennorm für Emissionen, Teil 2: Industrielle Umwelt

EN 55011: 1991 Beschränkungen und Methoden der Messung von Funkstörungsmerkmalen industrieller, wissenschaftlicher und medizinischer Hochfrequenzgeräte (Gruppe 1, Klasse A)

EN 61000-3-2: 1995 Grenzen der Oberwellenstromemissionen

EN 61000-3-3: 1995 Grenzen der Spannungsschwankungen und Flimmern

73/23/EEC Niederspannungsrichtlinie zu entsprechen

EN 61010-1: 1993 Sicherheitsrichtlinien für Elektrogeräte zur Messung, zur Steuerung und im Labor, Teil 1: Allgemeine Richtlinien

Declara que el producto siguiente:

Español

Designación: Serie 981, 982, 983, 984
Número de modelo: 9 8 (1 2 3 ó 4) (Cualquier letra) - (1 ó 2) (0 3 ó 5) (B C D E F o K) (A B C D E F K o T) (A B C J K M N o T) (A B C D E K R S o T) (Cualquier combinación de dos letras)

Clasificación: Control, categoría de instalación II, grado de contaminación ambiental II

Tensión nominal: 100 a 240 V~ o 24 a 28V

Frecuencia nominal: 50/60 Hz

Consumo nominal de energía: 16 VA máximo

Cumple con los requisitos esenciales de las siguientes directivas de la Unión Europea, usando las secciones pertinentes de las reglas normalizadas y los documentos relacionados que se muestran:

89/336/EEC - Directiva de compatibilidad electromagnética

EN 50082-2: 1995 Norma de inmunidad genérica del EMC, parte 2: Ambiente industrial

EN 61000-4-2: 1995 Descarga electrostática

EN 61000-4-4: 1995 Perturbaciones transitorias eléctricas rápidas

EN 61000-4-3: 1996 Inmunidad radiada

EN 61000-4-6: 1996 Inmunidad conducida

ENV 50204: 1995 Teléfono portátil

EN 50081-2: 1994 Norma de emisión genérica del EMC, parte 2: Ambiente industrial

EN 55011: 1991 Límites y métodos de medición de características de perturbaciones de radio correspondientes a equipos de radiofrecuencia industriales, científicos y médicos (Grupo 1, Clase A)

EN 61000-3-2: 1995 Límites para emisiones de corriente armónica

EN 61000-3-3: 1995 Limitaciones de fluctuaciones del voltaje

73/23/EEC Directiva de baja tensión

EN 61010-1: 1993 Requerimientos de seguridad para equipos eléctricos de medición, control y uso en laboratorios, Parte 1: Requerimientos generales

Erwin D. Lowell Winona, Minnesota, USA

Name of Authorized Representative Place of Issue

General Manager January 24, 1996

Title of Authorized Representative Date of Issue



Signature of Authorized Representative

(1229)

Watlow Series 982 User's Manual

Watlow Controls, 1241 Bundy Boulevard., P.O. Box 5580, Winona, Minnesota USA 55987-5580
Phone: (507) 454-5300, Fax: (507) 452-4507 <http://www.watlow.com>