

**INSTRUCTIONS FOR THE 32DZ SERIES 1/32 DIN
DUAL ZONE MICROPROCESSOR BASED
TEMPERATURE /PROCESS CONTROL**



PROHEAT

Excellence in distribution

<http://www.proheatinc.com>

117 East Adams Street

P.O. Box 48

LaGrange, KY 40031

Phone (502) 222-1402 Fax (502) 222-0714

Contents

INSTALLATION	3
WIRING	5
Wiring for Optional Inputs and Outputs	6
Wiring for 4 to 20mA Transmitter inputs	7
FRONT PANEL KEY FUNCTIONS	8
NOTATION CONVENTIONS FOR THE MENUS	10
THE HOME DISPLAY	10
ALARM TYPE AND ACTION	11
OPERATION OF SELF TUNE® FUNCTION	12
Theory of Operation	12
Program Setup and Operation	13
OPERATION AND PROGRAMMING OF OPTIONS	13
Option 992, Serial Communication.	13
FACTORY DEFAULT PROCEDURE	14
MENU SELECTIONS	14
PRIMARY MENU	14
SECONDARY MENU	15
SECURE MENU	25
SPECIFICATIONS	35
DIAGNOSTIC ERROR MESSAGES	37
DIAGNOSTIC ERROR MESSAGES	38
DIMENSIONS	40

MODEL IDENTIFICATION

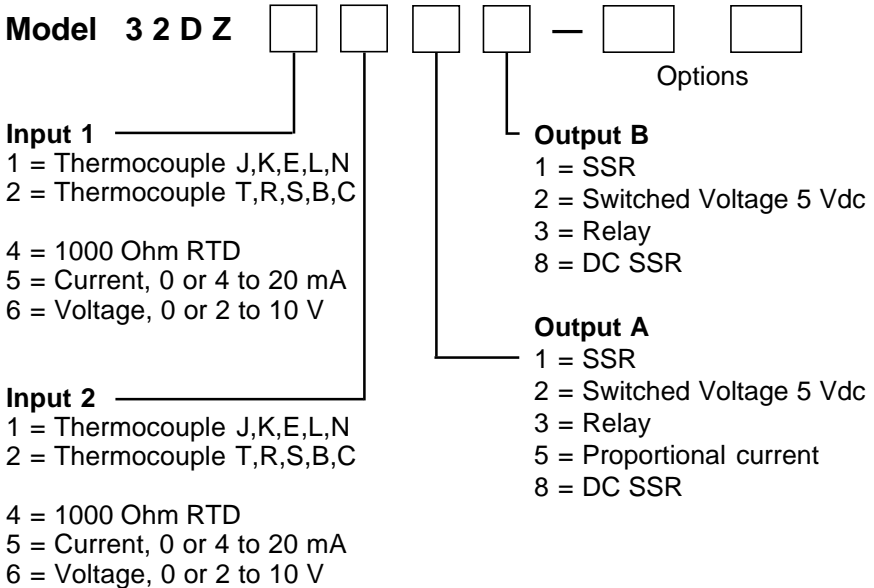

Options:

- 992 RS-485 Serial Communications. Allows remote computer to read and write all control parameters.
- 9502 12 - 24 Vdc/Vac 50-400Hz power supply (control operates on low voltage equipment).

INSTALLATION

All models are designed for mounting in an enclosed panel. Select the position desired for the instrument on the panel. If more than one instrument is required, maintain the minimum of spacing requirements as shown on the drawing opposite. Closer spacing will structurally weaken the panel, and invalidate the IP66, UL type 4 rating of the panel.



It is not necessary to remove the instrument chassis from the housing for installation. If the instrument chassis is removed from the housing, you must follow the ANSI/IPC-A-610 standard for handling electronic assemblies to avoid damage from Electro-Static Discharge (ESD). Failure to properly handle the instrument may cause damage to the instrument.

Prepare the panel by cutting and deburring the required opening(s).

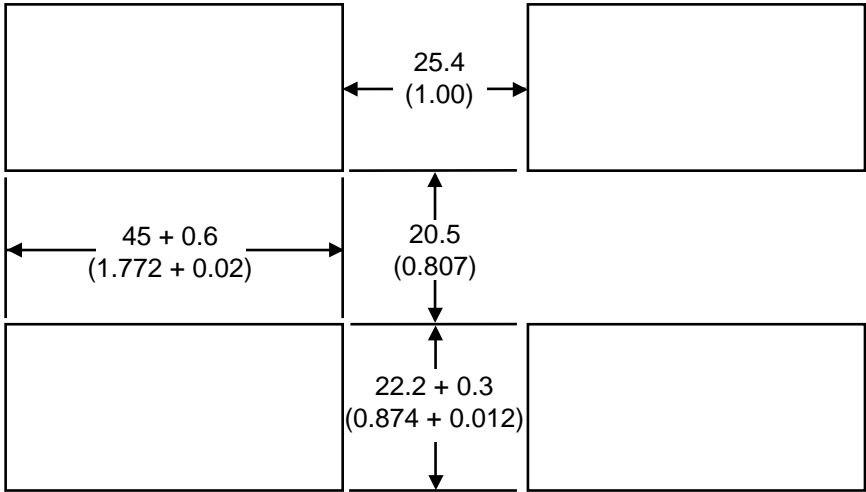

From the front of the panel, slide the housing through the cutout. The housing gasket should be flat against the housing flange before installing.

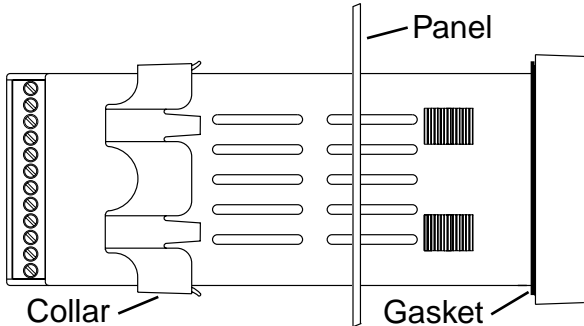

From the rear of the panel slide the mounting collar over the housing. Hold the housing with one hand and using the other hand, push the collar evenly against the panel until the spring loops are slightly compressed. The ratchets will hold the mounting collar and housing in place. To remove, gently lift the ratchets and slide a piece of heavy paper or mylar sheet under each ratchet (a business card works well). Slide the collar off of the housing.

WIRING



WARNING: The inputs of the instrument are not isolated from each other. The input sources must be isolated from each other. Thermocouples **MUST** be of the isolated junction type. Process inputs may not share a common external ground.



FAILURE TO OBSERVE THIS WARNING MAY CAUSE DANGEROUS OR LETHAL VOLTAGES TO BE PRESENT IN THE INSTRUMENT WHICH MAY CAUSE SERIOUS INJURY OR DEATH.



DO NOT RUN SIGNAL (CLASS 2) WIRING IN THE SAME CONDUIT OR CHASE AS THE POWER WIRING. ERRATIC OPERATION OR DAMAGE TO THE INSTRUMENT CIRCUITRY WILL RESULT.



Use only the type of thermocouple or RTD probe for which the control has been programmed. Maintain separation between wiring of sensor, auxiliary in or out, and other wiring. See the "Secure Menu" for input selection.

For thermocouple input always use extension leads of the same type designated for your thermocouple.

For supply connections use No. 18 AWG wires rated for at least 75°C. Use copper conductors only. All line voltage output circuits must have a common disconnect and be connected to the same pole of the disconnect.

Input wiring for thermocouple, voltage, current, and RTD; and output wiring for current, DC SSR, and 5 VDC is rated CLASS 2.

Control wiring is as shown.

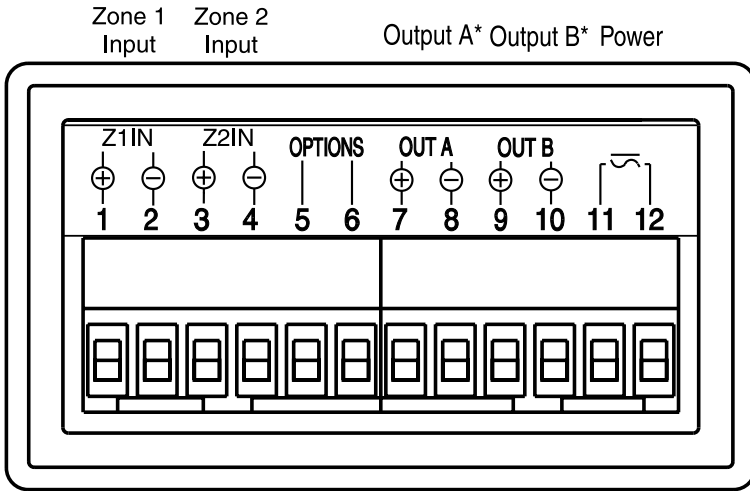

* Output A is assigned to Zone 1 Input and Output B is assigned to Zone 2 Input. If necessary, the input/output relationships may be reversed. See 5P in Secure Menu.

The wiring terminals for the 32DZ are compression type. To open the wiring terminal, turn the screw for that terminal counterclockwise. Slide the wire into the terminal space. While holding the wire in place, turn the screw clockwise to tighten. Maximum torque is 0.424 N·m(3.75 in. lb.). Do not overtighten. The wire should be held snugly in place.

Wiring for Optional Inputs and Outputs

Wire power and outputs as shown. Wiring for options is shown below. All wiring shown below is Class 2. Shielded twisted pair is required for Option 992.

Option 992: Terminal 5 is line A (-).
Terminal 6 is line B (+).
Last control in chain must have 120 ohm \pm 1% resistor across 5 and 6.

Option 9502: Connect 12 to 24 Volt ac or dc power to terminals 11 and 12. No polarity.

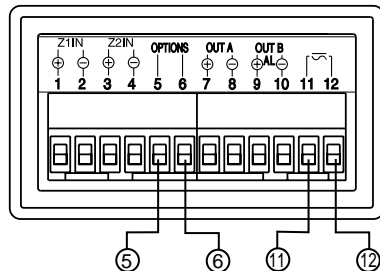

Note: Industry standard designation for RS-485 lines is A and B. Some equipment manufacturers use a non-standard designation of plus and minus. The association of A to minus and B to plus is based on a sample of devices marked as plus and minus and is not intended to represent ALL such labelled devices. Final responsibility for correct identification of leads and terminals rests with the user/installer and the manufacturer of the other device(s) installed in the system.

Wiring for 4 to 20mA Transmitter inputs



WARNING: The inputs of the instrument are not isolated from each other. The input sources must be isolated from each other. Process inputs may not share a common external ground.



FAILURE TO OBSERVE THIS WARNING MAY CAUSE DANGEROUS OR LETHAL VOLTAGES TO BE PRESENT IN THE INSTRUMENT WHICH MAY CAUSE SERIOUS INJURY OR DEATH.

Wire power and outputs as shown above. Two-wire transmitters wire as shown below.

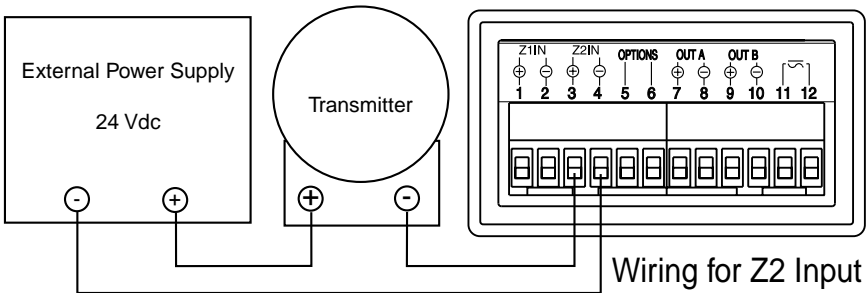
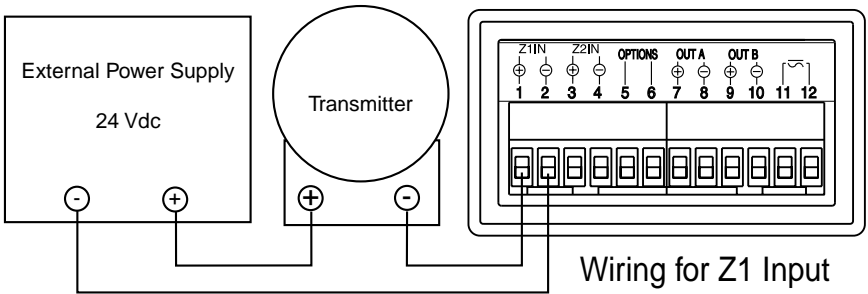

For three or four wire transmitters follow the wiring instructions provided with your transmitter.



DO NOT WIRE THE 24 VOLT POWER SUPPLY ACROSS THE INPUT OF THE CONTROL. DAMAGE TO THE INSTRUMENT INPUT CIRCUITRY WILL RESULT.

FRONT PANEL KEY FUNCTIONS

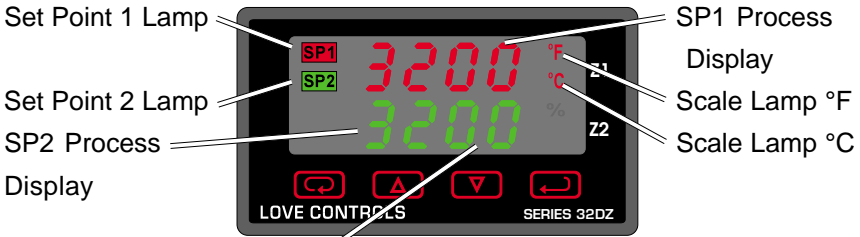



The decimal point flashes when Self-Tune is operating.

Keys are illuminated when pressed. Key functions are as follows:

 **INDEX:** Pressing the INDEX key advances the display to the next menu item. May also be used in conjunction with other keys as noted below.

 **UP ARROW:** Increments a value, changes a menu item, or selects the item to ON. The maximum value obtainable is 9999 regardless of decimal point placement.

 **DOWN ARROW:** Decrements a value, changes a menu item, or selects the item to OFF. The minimum value obtainable is -1999 regardless of decimal point placement.

 **ENTER:** Pressing ENTER stores the value or the item changed. If not pressed, the previously stored value or item will be retained. The display will flash once when ENTER is pressed.

 **UP ARROW & ENTER:** Pressing these keys simultaneously brings up the secondary menu starting at the alarm, tune, or cycle item (depending on programming). Pressing these keys for 5 seconds will bring up the secure menu.

 **INDEX & DOWN ARROW:** Pressing these keys simultaneously will allow backing up one menu item, or if at the first menu item they will cause the display to return to the primary menu. If an alarm condition has occurred, these keys may be used to reset the alarm.

 **INDEX & ENTER:** Pressing these keys simultaneously and holding them for 5 seconds allows recovery from the various error messages. The following menu items will be reset:

OPEn InP: Input error message **bAd InP:** Input error message

CHEC CAL: Check calibration error



Correct the problems associated with the above conditions before using these reset keys. More than one error could be present. Caution is advised since several items are reset at one time.



While in the **Primary or Secondary Menu**, if no key is pressed for a period of 30 seconds, the display will return to the HOME position displaying the

temperature value. While in the **Secure Menu**, if no key is pressed for a period of 60 seconds, the display will return to the HOME position displaying the temperature value. Outputs are disabled (turned off) when the **Secure Menu** is active.

NOTE: To move to the **Primary Menu** quickly from any other menu, press the **UP ARROW & ENTER** keys followed by pressing the **INDEX & DOWN ARROW** keys.

SECURITY LEVEL SELECTION

Four levels of security are provided. The display shows the current security level. To change security levels change the password value using the  **UP ARROW** and  **DOWN ARROW** keys and pressing the  **ENTER** key. Refer to the password table (following) for the correct value to enter for the security level desired. The **SEC 1** or **SEC 2** menu items security level may be viewed or changed at any time regardless of the present security level.

To set the access level to, for example, **2**, at the **SEC 1** menu item press the  **UP ARROW** key until the upper display shows the password, **1101**. Press the  **ENTER** key. The display will blink, and return with the level value, **2**, in the upper display.

The password values shown in the table cannot be altered, so retain a copy of these pages for future reference. This is the only reference made to password values in this instruction book.

PASSWORD TABLE

Menu	Security Level Status	Displayed Value When Viewed	Password Value To Enter
Primary Secondary Secure	Locked Locked Locked	1	1110
Primary Secondary Secure	Unlocked Locked Locked	2	1101
Primary Secondary Secure	Unlocked Unlocked Locked	3	1011
Primary Secondary Secure	Unlocked Unlocked Unlocked	4	1111

NOTATION CONVENTIONS FOR THE MENUS

Because of the number of features available in this control, information is included that may not apply to your specific control. All usable features are included in this book, but may not be used in your process. To increase clarity the following conventions are used:

1. Certain features, Menu Items, and functions shown in this book may or may not appear on your control, depending on other Menu Item selections. At various places in the Menu there are notes identifying Menu Items that "control" or "direct" other menu items. If you are looking for a particular menu item and can't find it, check the menu item that is its "control" for proper setting.
2. The "#" symbol is used in two ways. It is used inside a group of characters to indicate which set point function (SP1 or SP2) is being affected. It is also used before a group of characters of a menu item to indicate that there may be more than one selection or value for that menu item. This is used for certain repeated items such as in the Ramp/Soak Program section.
3. *Features that apply only to Options will be printed in Italics.*

THE HOME DISPLAY

The home display is the normal display while the control is operating. If no errors or functions are active, the HOME display will indicate the Process Variable (the temperature, pressure, flow, RH, etc., that is being measured) for Set Point 1 on the top display and the Process Variable for Set Point 2 on the bottom.

THE MENU EDIT FUNCTION

The Menu Edit function ($Ed \#$) allows quick access to operational and set up menu items for either or both of the zones. The Edit menu item appears at the top of the Secondary Menu and allows selection of the set point parameters. Setting $Ed \#$ to 0 allows access to only the Peak ($PEAK 1$ and $PEAK 2$), Valley ($VAL 1$ and $VAL 2$), Local/Remote ($LDR-E$), and address ($Addr$) menu items.

Setting $Ed \#$ for either 1 or 2 allows access to the Secondary and Secure Menus for the zone selected.

Setting $Ed \#$ for 3 allows access to both the Secondary and Secure Menus for both Zone 1 and Zone 2. Each menu presents the menu items for Zone 1 first, followed by the menu items for Zone 2, followed by any common menu items that may be present.

Menu items that are dedicated to either Zone 1 or Zone 2 will have either a 1 or 2 in them for identification.

If *Exit* is set to any value other than 0, the setting will be retained for a period of five minutes to allow handy, repeated access to that zone's menus. After five minutes of keypad inactivity, the *Exit* setting will revert to 0, giving an added layer of security to prevent inadvertent changes to the instrument.

PROGRAMMING SET POINTS FOR ALARM FUNCTIONS





Caution: In any critical application where failure could cause expensive product loss or endanger personal safety, a redundant limit controller is required.

The 32DZ Series allows Zone 1 and / or Zone 2 to operate as limit or alarm type outputs. This function is available on both outputs. To enable a zone output to act as an alarm or limit, *Out 1* (for Zone 1) or *Out 2* (for Zone 2) should be set for *OnOff*.

When *Out 1* and / or *Out 2* are set to *OnOff*, then the alarm function menu items will appear in the Secure Menu for the selected zone(s).

When Set Point Power Interrupt (*S#P*) is programmed *On* and Set Point Reset (*S#rE*) is programmed for *Hold*, the alarm will automatically reset after a power failure and on subsequent power restoration if no alarm condition is present.

If Set Point Inhibit (*S#IH*) is selected *On*, an alarm condition is suspended upon power up until the process value passes through the alarm set point once. Alarm inhibit can be restored as if a power up took place by pressing both the  **INDEX** and  **ENTER** keys for 5 seconds.



Warning: If inhibit is on and a power failure occurs during a high alarm, on restoration of power inhibit will suppress the alarm. Do not use the Set Point Inhibit feature if a hazard may be created by this action. Be sure to test all combinations of high and low set point inhibit actions before placing control into operation.

Set Point 2 Tracking

Some applications will call for Set Point 2 to follow or 'track' the setting for Set Point 1. This can be done by changing the $S2t$ setting in the Secure Menu ($E d t$ set for 2 or 3). For a tracking $SP2$, set $S2t$ to dE .

The Factory Default setting for $S2t$ is $Rb5$, making $SP2$ completely independent of $SP 1$.

When setting $SP2$ value when Set Point 2 is programmed as deviation ($S2t = dE$), set the difference in value from the Set Point 1 ($SP 1$) desired. For example if Set Point 2 is required to be 5 degrees below the $SP 1$, then set $SP2$ to -5 . If Set Point 2 is required 20 degrees above the $SP 1$, then set $SP2$ to 20 . If $SP 1$ is changed, the $SP2$ setting will continue to hold the same relationship as originally set.

When setting $SP2$ value when Set Point 2 is programmed as absolute ($S2t = AbS$), simply set the value at which the alarm is to occur.

OPERATION OF SELF TUNE® FUNCTION

Self Tune® allows automatic selection of the necessary parameters to achieve best control operation from your 32DZ Series control. If you are using the control output as a simple on-off function (e.g. $Out 1$ set for $OnOff$), none of the following will apply.

Theory of Operation

The Self Tune function calculates the $Pb 1$, $rES 1$, and $rEE 1$ parameters under the $P 1d 1 tuncE$ selection, $Pb2$, $rES2$, and $rEE2$ parameters under the $P 1d2 tuncE$ selection, the $Fbd 1$ and $Frt 1$ parameters, and the $Fbd2$ and $Frt2$ parameters, as shown in the Secondary Menu. These values are determined by measuring the response of the process connected to the control. When Self Tune is started, the control temporarily acts as an on-off control. While in this mode the control measures the overshoot and undershoot of the process, and the period of the process (the time from peak value to the next peak value). These measurements are collected over a period that lasts three periods of overshoot and undershoot. The data collected over this time is then compared and calculated into final PID and Fuzzy Logic values. The effect of Fuzzy Logic on the process is still controlled by the $F 1 1$ and $F 1 2$ (fuzzy intensity) settings. If $F 1 1$ or $F 1 2$ is 0, the $Fbd 1$, $Frt 1$, $Fbd2$, and $Frt2$ will be calculated, but will have no effect.

The calculations for Zone 1 and Zone 2 are completely independent. Each zone has separate Self Tune and Fuzzy Logic parameters.

The calculations for the PID values are the same as used in the standard Ziegler - Nichols equations that have been recognized as standard for decades.

The only modification to the application of the Ziegler - Nichols equations is controlled by the **dFC 1** and **dFC 2** menu items. These menu items control the amount of rate (derivative) that is applied. A **dFC 1** or **dFC 2** setting of **3** (factory default) or less allows for less damping. A **dFC 1** or **dFC 2** setting of **4** allows for critical damping as set forth in Ziegler - Nichols. A **dFC 1** or **dFC 2** setting of **5** or more allows over damping of the process.

Program Setup and Operation

In the secondary menu set **tun 1** or **tun 2** to **SELF**. Skip **Lrn 1** / **Lrn 2** and check to make sure that **dFC 1** / **dFC 2** is (are) set to the desired value. Back up to **Lrn 1** / **Lrn 2** and set to **YES**. The control will begin the Self Tune function. While the Self Tune function is active, the right hand decimal point on the lower display will blink. When Self Tune is complete, the blinking will stop.

After Self Tune is complete, the **tun 1** / **tun 2** setting(s) automatically switch(es) to **P Id**. This allows examination and / or modification of the values calculated. We recommend that you do not change the calculated values unless you have a firm understanding of the parameters involved and their function. For more information on PID tuning, please contact your supplier.

OPERATION AND PROGRAMMING OF OPTIONS

Option 992, Serial Communication.

The serial communications option allows the control to be written to and read from a remote computer or other similar digital device. Communication is allowed through a RS-485 (Option 992) port.

See Wiring for Optional Inputs and Outputs for information on wiring the communication lines. Wiring for the RS-485 is run from control to control in a daisy chain fashion with a termination resistor (120 ohms) across the transmit and receive terminals of the last control in the chain.

Select the control address and communication baud rate with the **Addr** and **BAUD** menu items in the Secure Menu. The address for Zone 1 will be the address selected. The address for Zone 2 will be the address selected for Zone 1 plus one. For example, if **Addr** is set to **#E**, Zone 1 parameters will be addressed through address **#E** and Zone 2 parameters will be addressed through address **#F**.









THE BAUD RATE AND ADDRESS MENU ITEMS WILL TAKE EFFECT ON THE NEXT POWER UP OF THE CONTROL. BE SURE TO POWER CYCLE THE CONTROL BEFORE USING THE NEW BAUD RATE AND ADDRESS.

In operation, you have the option of preventing a write command from the host computer. To prevent the host from writing to the control change the **LDrE** menu item in the Secondary Menu to **LDC**. To allow the host to write commands to the control set **LDrE** to **rE**. (The host does have the ability to change the **LDrE** state, but it is not automatic.)

If your system depends on constant reading or writing to and from the host, you may wish to set the No Activity Timer (**nAt**) to monitor the addressing of the control. When the **LDrE** is set to **rE** and the **nAt** is set to any value other than **OFF**, the control will expect to be addressed on a regular basis. If the control is not addressed in the time set by the value of **nAt**, then the control will display the error message **CHEC LDrE**. To clear the message set **LDrE** to **LDC**.

FACTORY DEFAULT PROCEDURE

If for any reason you wish to restore the factory settings use the following procedure.

1. Turn off power to control
2. Turn on power to control
3. While control is performing **SELF tEST**, press and hold the  INDEX and  ENTER keys.
4. The control will display the ROM ID code. Press  INDEX.
5. The control will display **FACT dFLT**. If you wish to just restore factory settings, Press  ENTER and  DOWN ARROW at the same time. The control will be reset to the original factory settings.
6. Press  INDEX to display **Opt**. If your control is equipped with an option, press the UP ARROW to display the option number. If the number is flashing, press  ENTER. An enabled option does not flash.
7. Press  INDEX to display **ACPt**. Select **YES** or **no**.
YES Changes are accepted and control re-boots.
no Changes are discarded and control re-boots.
8. Press  ENTER.

The control will re-initialize with Factory Default settings.

MENU SELECTIONS

PRIMARY MENU

Press **INDEX** to advance to the next menu item. Press **UP ARROW** or **DOWN ARROW** to change the value in the display. Press **ENTER** to retain the value.

SP 1 Set Point 1 Adjust, Control Point 1.

SP 2 Set Point 2 Adjust, Control Point 2.

SECONDARY MENU

Hold **UP ARROW & ENTER**. Press **INDEX** to advance to the next menu item. Press **UP ARROW** or **DOWN ARROW** to change the value in the display. Press **ENTER** to retain the value.

Edit Edit Set Point parameters: Select **0**, **1**, **2**, or **3**.

- 0** Edit function is off.
- 1** Edit Secondary and Secure Menus for Set Point 1.
- 2** Edit Secondary and Secure Menus for Set Point 2.
- 3** Edit Secondary and Secure Menus for both Set Points in sequence (menu items for Set Point 1 followed by menu items for Set Point 2).

If **Edit** is set to **0**, begin.

If **Edit** is set to **1** or **3**, jump to **Out 1** on page 17.

If **Edit** is set to **2**, jump to **Out 2** on page 21.

PER 1 The Peak feature stores the highest input the control has measured for Zone 1 since the last reset or Power On. At Power On, **PER 1** is reset to the present input value. To manually reset the value **PER 1** must be in the lower display. Press the **ENTER** key to reset. **PER 1** will be reset and display the present input value.

VAL 1 The Valley feature stores the lowest input the Instrument has measured for Zone 1 since the last reset or Power On. At Power On, **VAL 1** is reset to the present input. To manually reset the value **VAL 1** must be in the lower display. Press the **ENTER** key. **VAL 1** will be reset and display the present input value.

PER 2 The Peak feature stores the highest input the control has measured for Zone 2 since the last reset or Power On. At

Power On, **PER2** is reset to the present input. To manually reset the value **PER2** must be in the lower display. Press the **ENTER** key to reset. **PER2** will be reset and display the present input value.

URL2 The Valley feature stores the lowest input the Instrument has measured for Zone 2 since the last reset or Power On. At Power On, **URL2** is reset to the present input. To manually reset the value **URL2** must be in the lower display. Press the **ENTER** key. **URL2** will be reset and display the present input value.

LORÉ (Option 992, Serial Communications) Local / Remote Status: Select **LOC** or **rÉ**.

LOC The host computer is advised not to send remote commands. Any write commands sent to the controls will be rejected.

rÉ The host computer is allowed to send write commands. If the control is not addressed within the time set in the **nAt** (No Activity Timer, see Secure Menu) the **CHÉC LORÉ** error message will be displayed.

Addr (Option 992, Serial Communications) Control Address: Set from **1** to **3FF**. This number (hexadecimal, base 16) must match the address number used by the host computer. Viewed only in this menu. The value displayed is for Zone 1. The address for Zone 2 is the value for Zone 1 plus one. To change this parameter, see **Addr** in the Secure Menu.

End of Secondary Menu when Éd it is set to 0.

If $E d t$ is set to 1 or 3, begin.

If $E d t$ is set to 2, jump to $O u t 2$ on page 20.

$O u t 1$ Output selection: Select $O n O F$, $t P$, or $i P u L$.

$O n O F$ A setting of $O n O F$ allows the control to operate as a simple on/off mode. This setting forces the control to turn off at set point, and on at the set point plus the differential ($S P d$). When selected, the $O u t 1 / O n O F$ menu item is followed by ##### $S P d$, and the $t u n 1$, $P b 1$, $r E S 1$, $O F S 1$, $r t E 1$, and $R r S 1$ selections in the Secondary menu and the $S I O L$ and $S I O H$ selections in the Secure menu are suppressed.

$S P d$ Set Point On-Off Differential (hysteresis). Select 1 to 9999 (direct acting), or -1 to -9999 (reverse acting). This value will be negative for reverse acting set points, and positive for direct acting outputs. Set the value for the amount of difference between the turn off point (set point) and the turn on point. The following drawing shows output behavior for reverse and direct action.

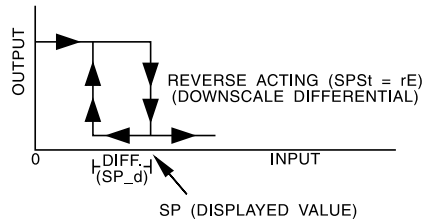
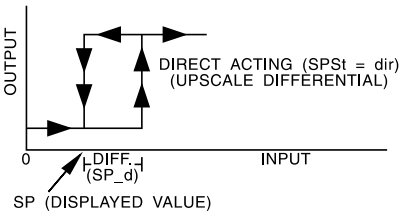

##tP Time Proportioning Cycle Time. Select $t P$ to $80 t P$.

tP A setting of $t P$ is recommended for solid state outputs (SSR, DC SSR, or 5VDC).

2tP to 80tP Time Proportioning Control is adjustable in 1 second steps. Recommended for mechanical outputs (relays, solenoids, etc.). For best contact life, a time should be selected as long as possible without causing the process to wander.

#P u L Pulsed Time Proportioning Output: Select $i P u L$ to $7 P u L$. $i P u L$ = Linear and $7 P u L$ = most nonlinear. Changes output linearity for use in cooling applications or for an extremely fast response processes. At the center of the proportional band, a pulse

value of 1 provides an output of one second on and one second off (50% output). A pulse value of 2 provides an output of one second on and two seconds off (33% output). Output at center of band equals one second on, $2^{(\text{pulse value}-1)}$ seconds off.

PrOP For Current (Code 5) outputs only.

- tun i** Tuning Choice: Select **SELF**, **P id**, **SLD**, **nor**, or **FAST**.
- SELF** The instrument will evaluate the Process and select the PID values to maintain good control. Active for SP1 only.
- Ln i** Select **YES** or **no**
- YES** Start Learning the Process. After the process has been learned the menu item will revert to **no**.
- no** Learning will stay in present mode.
- dFC i** Damping factor, Select **OFF**, **1** to **7**. Sets the ratio of Rate to Reset for the SELF tune mode. **7** = most Rate. Factory set to **3**. For a fast response process the value should be lowered (less Rate). For a slower process the value should be increased (more Rate).
- P id** Manually adjust the PID values. PID control consists of three basic parameters, Proportional Band (Gain), Reset Time (Integral), and Rate Time (Derivative).
- Pb i** Proportional Band (Bandwidth). Select **1** to **9999** °F, °C, or counts.
- rES i** Automatic Reset Time. Select **OFF**, **0.1** to **99.9** minutes. Select **OFF** to switch to **OFFS i**.
- OFFS i** Manual Offset Correction Select **OFF**, **0.1** to **99.9%**. Select **OFF** to switch to **rES i**.
- rTE i** Rate Time. Select **OFF**, **0.01** to **99.99** minutes, Derivative.
- SLD** PID values are preset for a slow response process.
- nor** PID values are preset for a normal response process.
- FAST** PID values are preset for a fast response process.
- ARS i** Anti-Reset Windup Feature: Select **On** or **OFF**.
- On** Reset Offset value will be cleared to 0% when the process input is not within the Proportional Band.

OFF Reset Offset Value is retained in memory when the process input is not within the Proportional Band.

Art I Approach Rate Time: Select **OFF, 0.0 I** to **99.99** minutes. The function defines the amount of Rate applied when the input is outside of the Proportional Band. The **Art I** time and the **rEt I** time are independent and have no effect on each other. To increase damping effect and reduce overshoot set the approach rate time for a value greater than the natural rise time of the process (natural rise time = process value time to set point).

F. I Fuzzy Logic Intensity: Select **0** to **100%**. **0%** is OFF (disables Fuzzy Logic). The function defines the amount of impact Fuzzy Logic will have on the output. If **F. I** is set to **0**, **Fbd I** and **Frk I** below will not appear.

Fbd I Fuzzy Logic Error Band: Select **0** to **4000** °F, °C, or counts. Sets the bandwidth of the Fuzzy Logic. Set **Fbd I** equal to PID proportional band (**Pb I**) for best results. Self Tune, when used, calculates this value. Will not appear if **F. I** is **0**.

Frk I Fuzzy Logic Rate of Change: Select **0.00** to **99.99** counts/second. For best initial setting, find the count/second change of process value near Set Point 1 with output ON (100% output). Multiply this value by 3. Set **Frk I** to this calculated value. Self Tune, when used, calculates this value. Will not appear if **F. I** is **0**.

PER I The Peak feature stores the highest input the control has measured for Zone 1 since the last reset or Power On. At Power On, **PER I** is reset to the present input value. To manually reset the value **PER I** must be in the lower display. Press the **ENTER** key to reset. **PER I** will be reset and display the present input value.

VAL I The Valley feature stores the lowest input the Instrument has measured for Zone 1 since the last reset or Power On. At Power On, **VAL I** is reset to the present input. To manually reset the value **VAL I** must be in the lower display. Press the **ENTER** key. **VAL I** will be reset and display the present input value.

InC 1 Input Correction: Select **-500** to **500** °F, °C, or counts. This feature allows the input value to be changed to agree with an external reference or to compensate for sensor error. **Note:** *InC 1* is reset to zero when the input type is changed, or when decimal position is changed.

F.L 1 Digital Filter: Select **OFF**, **1** to **99**. In some cases the time constant of the sensor, or noise could cause the display to jump enough to be unreadable. A setting of **2** is usually sufficient to provide enough filtering for most cases, (**2** represents approximately a 1 second time constant). When the 0.1 degree resolution is selected this should be increased to **4**. If this value is set too high, controllability will suffer.

LPb 1 Loop Break Protection: Select **OFF**, **1** to **9999** seconds. If, during operation, the output is minimum (0%) or maximum (100%), and the input moves less than 5°F (3°C) or 5 counts over the time set for *LPb 1*, the **LOOP bAd** message will appear. The loop break error can be reset by pressing the **ENTER** key when at the *LPb 1* menu item. The **INDEX & ENTER** keys may also be used.

If *Ed.t* is set to **1**, jump to *LorE* on page 24.

If *Ed.t* is set to **3**, continue.

If $E_d t$ is set to 1, jump to $LorE$ on page 24.

If $E_d t$ is set to 3, continue.

If $E_d t$ is set to 2, begin.

Out2 Output selection: Select **OnOF**, **ItP**, or **IPuL**.

OnOF A setting of **OnOF** allows the control to operate as a simple on/off mode. This setting forces the control to turn off at set point, and on at the set point plus the differential (**SP2d**). When selected, the **Out2/OnOF** menu item is followed by **####/SP2d**, and the **tun2**, **Pb2**, **rES2**, **OF52**, **rtE2**, and **Ar52** selections in the Secondary menu and the **S2OL** and **S2OH** selections in the Secure menu are suppressed.

SP2d Set Point On-Off Differential (hysteresis). Select 1 to 9999 (direct acting), or -1 to -9999 (reverse acting). This value will be negative for reverse acting set points, and positive for direct acting outputs. Set the value for the amount of difference between the turn off point (set point) and the turn on point. The following drawing shows output behavior for reverse and direct action.

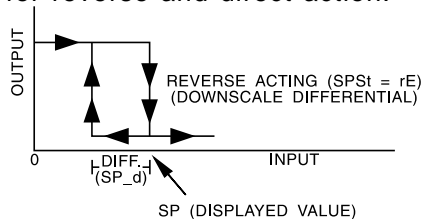
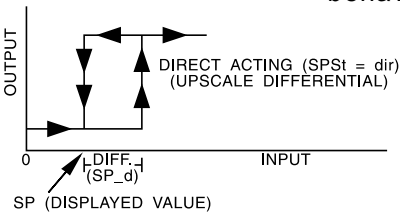

##tP Time Proportioning Cycle Time. Select **ItP** to **80tP**.

ItP A setting of **ItP** is recommended for solid state outputs (SSR, DC SSR, or 15VDC).

2tP to 80tP Time Proportioning Control is adjustable in 1 second steps. Recommended for mechanical outputs (relays, solenoids, etc.). For best contact life, a time should be selected as long as possible without causing the process to wander.

#PuL Pulsed Time Proportioning Output: Select **IPuL** to **7PuL**. **IPuL** = Linear and **7PuL** = most nonlinear. Changes output linearity for use in cooling applications or for an extremely fast response processes. At the

center of the proportional band, a pulse value of 1 provides an output of one second on and one second off (50% output). A pulse value of 2 provides an output of one second on and two seconds off (33% output). Output at center of band equals one second on, $2^{(\text{pulse value}-1)}$ seconds off.

- Learn** Tuning Choice: Select **SELF**, **Pid**, **SLO**, **nor**, or **FAST**.
- SELF** The Controller will evaluate the Process and select the PID values to maintain good control.
- Learn** Select **YES** or **no**
- YES** Start Learning the Process. After the process has been learned the menu item will revert to **no**.
- no** Learning will stay in present mode.
- DFC** Damping factor, Select **OFF**, **1** to **7**. Sets the ratio of Rate to Reset for the **SELF Learn** mode. **7** = most Rate. Factory set to **3**. For a fast response process the value should be lowered (less Rate). For a slower process the value should be increased (more Rate).
- Pid** Manually adjust the PID values. PID control consists of three basic parameters, Proportional Band (Gain), Reset Time (Integral), and Rate Time (Derivative).
- Pb** Proportional Band (Bandwidth). Select **1** to **9999** °F, °C, or counts.
- rES** Automatic Reset Time. Select **OFF**, **0.1** to **99.9** minutes. Select **OFF** to switch to **OF5**.
- OF5** Manual Offset Correction Select **OFF**, **0.1** to **99.9%**. Select **OFF** to switch to **rES**.
- rtE** Rate Time. Select **OFF**, **0.01** to **99.99** minutes, Derivative.
- SLO** PID values are preset for a slow response process.
- nor** PID values are preset for a normal response process.
- FAST** PID values are preset for a fast response process.

- Ar5** Anti-Reset Windup Feature: Select **On** or **OFF**.
- On** Reset Offset value will be cleared to 0% when the process input is not within the Proportional Band.

OFF Reset Offset Value is retained in memory when the process input is not within the Proportional Band.

Art2 Approach Rate Time: Select **OFF, 0.01** to **99.99** minutes. The function defines the amount of Rate applied when the input is outside of the Proportional Band. The **Art2** time and the **rte2** time are independent and have no effect on each other. To increase damping effect and reduce overshoot set the approach rate time for a value greater than the natural rise time of the process (natural rise time = process value time to set point).

F, 2 Fuzzy Logic Intensity: Select **0** to **100%**. **0%** is OFF (disables Fuzzy Logic). The function defines the amount of impact Fuzzy Logic will have on the output. If **F, 2** is set to **0**, **Fbd2** and **Frt2** below will not appear.

Fbd2 Fuzzy Logic Error Band: Select **0** to **4000** °F, °C, or counts. Sets the bandwidth of the Fuzzy Logic. Set **Fbd2** equal to PID proportional band (**Pb2**) for best results. Self Tune, when used, calculates this value automatically. Will not appear if **F, 2** is set to **0**.

Frt2 Fuzzy Logic Rate of Change: Select **0.00** to **99.99** counts/second. For best initial setting, find the count/second change of process value near set point 1 with output ON (Output is 100%). Multiply this value by 3. Set **Frt2** to this calculated value. Self Tune, when used, calculates this value automatically. Will not appear if **F, 2** is set to **0**.

PER2 The Peak feature stores the highest input the control has measured for Zone 2 since the last reset or Power On. At Power On, **PER2** is reset to the present input. To manually reset the value **PER2** must be in the lower display. Press the **ENTER** key to reset. **PER2** will be reset and display the present input value.

VAL2 The Valley feature stores the lowest input the Instrument has measured for Zone 2 since the last reset or Power On. At Power On, **VAL2** is reset to the present input. To manually reset the value **VAL2** must be in the lower display. Press the **ENTER** key. **VAL2** will be reset and display the present input value.

InC2 Input Correction: Select **-500** to **500** °F, °C, or counts. This feature allows the input value to be changed to agree with an external reference or to compensate for sensor error. **Note:** *InC2* is reset to zero when the input type is changed, or when decimal position is changed.

F.L2 Digital Filter: Select **OFF**, **1** to **99**. In some cases the time constant of the sensor, or noise could cause the display to jump enough to be unreadable. A setting of **2** is usually sufficient to provide enough filtering for most cases, (**2** represents approximately a 1 second time constant). When the 0.1 degree resolution is selected this should be increased to **4**. If this value is set too high, controllability will suffer.

LPb2 Loop Break Protection: Select **OFF**, **1** to **9999** seconds. If, during operation, the output is minimum (0%) or maximum (100%), and the input moves less than 5°F (3°C) or 5 counts over the time set for *Lpb2*, the **LOOP bAd** message will appear. The loop break error can be reset by pressing the **ENTER** key when at the *LPb2* menu item. The **INDEX & ENTER** keys may also be used.

The following Menu Items operate on the entire instrument. There is no Zone or Set Point distinction. They will appear in the **Ed.t1**, **Ed.t2**, and **Ed.t3** menus.

LOrE (Option 992, Serial Communications) Local / Remote Status: Select **LOC** or **rE**.

LOC The host computer is advised not to send remote commands. Any write commands sent to the controls will be rejected.

rE The host computer is allowed to send write commands. If the control is not addressed within the time set in the **nAt** (No Activity Timer, see Secure Menu) the **CHEC LOrE** error message will be displayed.

Addr (Option 992, Serial Communications) Control Address: Read value from **1** to **3FF**. This number (hexadecimal, base 16) must match the address number used by the host computer. Viewed only in this menu. The value displayed is for Zone 1. The address for Zone 2 is the value for Zone 1 plus one (e.g. if **Addr** is set to **17**, Zone 1 is assigned to

address **17** and Zone 2 is assigned to address **18**). To change this parameter, see **Addr** in the Secure Menu.

SECURE MENU

Hold **UP ARROW** & **ENTER** for 5 Seconds. Press **INDEX** to advance to the next menu item. Press **UP ARROW** or **DOWN ARROW** to change the value in the display. Press **ENTER** to retain the value. **OUTPUTS ARE DISABLED (TURNED OFF) WHILE THE INSTRUMENT IS IN SECURE MENU.**

If **Ed.k** is set to **0**, begin.

If **Ed.k** is set to **1** or **3**, jump to **5E1** on page 26.

If **Ed.k** is set to **2**, jump to **5E2** on page 29.

Note: There are no standard menu items for the Secure Menu when **Ed.k** is set to **0**.

Addr (Option 992, Serial Communications) Control Address: Select from **1** to **3FE**. This number (hexadecimal, base 16) must match the address number used by the host computer. The value displayed is for Zone 1. The address for Zone 2 is the value for Zone 1 plus one (e.g. if **Addr** is set to **17**, Zone 1 is assigned to address **17** and Zone 2 is assigned to address **18**). Addresses **100**, **200**, and **300** are reserved for Factory use.

baud (Option 992, Serial Communications) Communication Baud Rate: Select **300**, **1200**, **2400**, **4800**, **9600**, or **19200**. This number must match the baud rate used by the host computer.

nAt (Option 992, Serial Communications) No Activity Timer: Set from **OFF** or **1** to **99** minutes.

1 - 99 Maximum time between host computer accesses. If timer counts to 0, **CHEC L or E** will be displayed.

OFF No Activity Timer function is disabled.

End of Secure Menu when Ed.k is set to 0.

If *Edt* is set to 1 or 3, begin.

If *Edt* is set to 2, jump to *SECC* on page 30.

SEC 1 Security Code: See the Security Level Selection and the Password Table in this manual, in order to enter the correct password.

inp 1 Input Type: Select one of the following. Refer to the Input wiring section for the proper wiring.

Input Group 1	<input type="checkbox"/> <i>J- 1C</i>	Type "J" Thermocouple
	<input type="checkbox"/> <i>KA</i>	Type "K" Thermocouple
	<input type="checkbox"/> <i>E-</i>	Type "E" Thermocouple
	<input type="checkbox"/> <i>L-</i>	Type "L" Thermocouple
Input Group 2	<input type="checkbox"/> <i>n-</i>	Type "N" Thermocouple
	<input type="checkbox"/> <i>t-</i>	Type "T" Thermocouple
	<input type="checkbox"/> <i>r- 13</i>	Type "R" Thermocouple
	<input type="checkbox"/> <i>S- 10</i>	Type "S" Thermocouple
	<input type="checkbox"/> <i>b-</i>	Type "B" Thermocouple
	<input type="checkbox"/> <i>C-</i>	Type "C" Thermocouple

Input Group 4	<input type="checkbox"/> <i>IP38</i>	1000 ohm Platinum (DIN 0.00385 $\Omega/\Omega/^\circ\text{C}$)
Input Group 5	<input type="checkbox"/> <i>Curr</i>	DC Current Input 0.0 to 20.0 or 4.0 to 20.0 mA.
Input Group 6	<input type="checkbox"/> <i>Volt</i>	DC Voltage Input 0.0 to 10.0 or 2.0 to 10.0 volts.
	<input type="checkbox"/> <i>----</i>	Reserved



Caution: Do not change the Input Type outside of the programming Group on the Model Number. The input will not function correctly if the Input Type is set to a selection outside the specified Input Group.

OSP 1 Zero Suppression: Select *On* or *OFF*. Only with Current and Voltage input types.

OFF The input range will start at 0 (zero) Input.

On The input range will start at 4.00 mA or 2.00 V.

Unit 1 *F*, *C* or *nonE*.

F °F lamp is On and temperature inputs will be displayed in degrees Fahrenheit.

C °C lamp is On and temperature inputs will be displayed in degrees Celsius.

nonE Both the °F and °C lamps will be Off. This selection is only available with Current and Voltage Inputs.

Note: If both Set Point 1 and Set Point 2 are set for temperature inputs, they must both be set for the same scale. While it is possible to set one input as degrees F and the other degrees C, as there is only one descriptor, one of the displays is likely to be mis-read. If one Set Point is set for process input, you may select to display either the temperature descriptor or neither (nonE).

dPt 1 Decimal Point Positioning: Select **0**, **0.0**, **0.00**, or **0.000**. On temperature type inputs this will only effect the Process Value, **SP 1**, and **inC 1**. For Current and Voltage Inputs all Menu Items related to the Input will be affected.

0 No decimal Point is selected. This is available for all Input Types.

0.0 One decimal place is available for Type J, K, E, T, L, RTD's, Current and Voltage Inputs.

0.00 Two decimal places is only available for Current and Voltage Inputs.

0.000 Three decimal places is only available for Current and Voltage inputs.

Int 1 Input Fault Timer: Select **OFF**, **0.1** to **540.0** minutes. Whenever an Input is out of range (**UFL** or **DFL** displayed), shorted, or open the timer will start. When the time has elapsed, the instrument will disable the output(s) and display **bAd InP**. If **OFF** is selected, the Input Fault Timer will not be recognized (time = infinite).

SEn 1 Sensor Rate of Change: Select **OFF**, **1** to **4000** °F, °C, or counts per 1 second period. This value is usually set to be slightly greater than the fastest process response expected during a 1 second period, but measured for at least 2 seconds. If the process is faster than this setting, the **SEn 1 bAd** error message will appear. The outputs will then be turned off. This function can be used to detect a runaway condition, or speed up detection of an open thermocouple. Use the INDEX & ENTER keys to reset.

SCL 1 Scale Low: Select **100** to **9999** counts below **SCH 1**. The total span between **SCL 1** and **SCH 1** must be within 11998 counts. Maximum setting range is -1999 to 9999 counts. Minimum span is 100 counts. For Current and Voltage inputs, this will set the low range end. Viewable only for Thermocouple and RTD ranges.

SC H I Scale High: Select **100** to **9999** counts above **SC L I**. The total span between **SC L I** and **SC H I** must be within 11998 counts. Maximum setting range is - **1999** to **+9999** counts. Minimum span is 100 counts. For Current and Voltage inputs, this will set the high range end. Viewable only for Thermocouple and RTD ranges.

SP L I Set Point Low: Select from the lowest input range value to **SP H 1** value. This will set the minimum **SP I** value that can be entered. The value for **SP I** will not stop moving when this value is reached. Attempting to set a value for **SP I** lower than **SP L I** will result in a **[H E L] SP I** error. The value will not be accepted.

SP H I Set Point High: Select from the highest input range value to **SP L 1** value. This will set the maximum **SP I** value that can be entered. The value for **SP 1** will not stop moving when this value is reached. Attempting to set a value for **SP I** higher than **SP H I** will result in a **[H E L] SP I** error. The value will not be accepted.

S I S t Set Point State: Select **d i r** or **r E**.

- d i r** Direct Action. As the input increases the output will increase. Most commonly used in cooling processes.
- r E** Reverse Action. As the input increases the output will decrease. Most commonly used in heating processes.

If **Out I** is set for **##tP**, **#PUL**, or **P r o P**, then **S1OL** and **S1OH** (following) appear. If **Out I** is set for **0 n O F**, then skip to **S I r E**.

S I O L Set Point Output Low Limit: Select **0** to **90%** but not greater than **S I O H**. This item limits the lowest output value. This is useful for adding a bias to the process when needed. Factory set to **0** for output codes 1, 2, 3, and 8. Factory set to **20** for output code 5 (20% output equals 4 mA output).

S I O H Set Point Output High Limit: Select **10** to **100%** but not less than **S I O L** for output codes 1, 2, 3, or 8. Select **10** to **102%** but not less than **S1OL** for output code 5. This item allows setting the maximum output limit. This is useful with processes that are over powered. Adjustment to **102%** allows setting current output to force a full on condition for output

devices which do not have bias adjustments. Factory set to **100** for all output codes.

If **Out 1** is set for **##LP**, **#PUL**, or **ProP**, then skip to **S ILP**.

S IrE Set Point Reset. Select **OnOF** or **HoLd**.

OnOF Control will automatically reset when process passes back through **SP Id**.

HoLd Manual Reset. Reset (acknowledge) by simultaneously pressing the **INDEX & DOWN ARROW** keys for 5 seconds.

S IP , Set Point Power Interrupt. Select **On** or **OFF**.

On Alarm Power Interrupt is **On**. Control will automatically reset on power-up if no alarm condition exists.

OFF Alarm Power Interrupt is **OFF**. Control will power-up in alarm condition regardless of condition of process.

S I ,H Set Point Inhibit: Select **On** or **OFF**.

On Alarm Inhibit is **On**. Alarm action is suspended until the process value first enters a non-alarm condition.

OFF Alarm Inhibit is **OFF**.

S ILP Set Point Lamp: Select **O on** or **OoFF**.

O on Lamp ON when Output is **On**.

OoFF Lamp OFF when Output is **On**.

If **Ed it** is set to **1**, jump to **Addr** on page 33.

If **Ed it** is set to **3**, continue.

If *Edt* is set to 1, jump to *SP lo* on page 33.

If *Edt* is set to 3, continue.

If *Edt* is set to 2, begin.

SECP Security Code: See the Security Level Selection and the Password Table in this manual, in order to enter the correct password.

inp2 Input Type: Select one of the following. Refer to the Input wiring section for the proper wiring.

Input Group 1	<input type="checkbox"/> <i>J- 1C</i>	Type "J" Thermocouple
	<input type="checkbox"/> <i>KA</i>	Type "K" Thermocouple
	<input type="checkbox"/> <i>E-</i>	Type "E" Thermocouple
	<input type="checkbox"/> <i>L-</i>	Type "L" Thermocouple
Input Group 2	<input type="checkbox"/> <i>n-</i>	Type "N" Thermocouple
	<input type="checkbox"/> <i>t-</i>	Type "T" Thermocouple
	<input type="checkbox"/> <i>r- 13</i>	Type "R" Thermocouple
	<input type="checkbox"/> <i>S- 10</i>	Type "S" Thermocouple
	<input type="checkbox"/> <i>b-</i>	Type "B" Thermocouple
	<input type="checkbox"/> <i>C-</i>	Type "C" Thermocouple

Input Group 4	<input type="checkbox"/> <i>IP38</i>	1000 ohm Platinum (DIN 0.00385 $\Omega/\Omega/^\circ\text{C}$)
Input Group 5	<input type="checkbox"/> <i>curr</i>	DC Current Input 0.0 to 20.0 or 4.0 to 20.0 mA.
Input Group 6	<input type="checkbox"/> <i>volt</i>	DC Voltage Input 0.0 to 10.0 or 2.0 to 10.0 volts.
	<input type="checkbox"/> - - - -	Reserved



Caution: Do not change the Input Type outside of the programming Group on the Model Number. The input will not function correctly if the Input Type is set to a selection outside the specified Input Group.

OSP2 Zero Suppression: Select *On* or *OFF*. Only with Current and Voltage input types.

OFF The input range will start at 0 (zero) Input.

On The input range will start at 4.00 mA or 2.00 V.

Unt2 *F*, *C* or *nonE*.

F °F lamp is On and temperature inputs will be displayed in degrees Fahrenheit.

C °C lamp is On and temperature inputs will be displayed in degrees Celsius.

nonE Both the °F and °C lamps will be Off. This selection is only available with Current and Voltage Inputs.

Note: If both Set Point 1 and Set Point 2 are set for temperature inputs, they must both be set for the same scale. While it is possible to set one input as degrees F and the other degrees C, since there is only one descriptor, one of the displays is likely to be mis-read. If one Set Point is set for process input, you may select to display either the temperature descriptor or neither (nonE).

dPt2 Decimal Point Positioning: Select **0**, **0.0**, **0.00**, or **0.000**. On temperature type inputs this will only effect the Process Value, SP1, SP2, and InC1|InC2. For Current and Voltage Inputs all Menu Items related to the Input will be affected.

0 No decimal Point is selected. This is available for all Input Types.

0.0 One decimal place is available for Type J, K, E, T, L, RTD's, Current and Voltage Inputs.

0.00 Two decimal places is only available for Current and Voltage Inputs.

0.000 Three decimal places is only available for Current and Voltage inputs.

Int2 Input Fault Timer: Select **OFF**, **0.1** to **540.0** minutes. Whenever an Input is out of range (**UFL** or **OFL** displayed), shorted, or open the timer will start. When the time has elapsed, the instrument will disable the output(s) and display **bAd InP**. If **OFF** is selected, the Input Fault Timer will not be recognized (time = infinite).

SEn2 Sensor Rate of Change: Select **OFF**, **1** to **4000** °F, °C, or counts per 1 second period. This value is usually set to be slightly greater than the fastest process response expected during a 1 second period, but measured for at least 2 seconds. If the process is faster than this setting, the **SEn2 bAd** error message will appear. The outputs will then be turned off. This function can be used to detect a runaway condition, or speed up detection of an open thermocouple. Use the INDEX & ENTER keys to reset.

SCl2 Scale Low: Select **100** to **9999** counts below **SCH2**. The total span between **SCl2** and **SCH2** must be within 11998 counts. Maximum setting range is - **1999** to **+9999** counts. Minimum span is 100 counts. For Current and Voltage inputs, this will set the low range end. Viewable only for Thermocouple and RTD ranges.

SC_{H2} Scale High: Select **100** to **9999** counts above **SC_{L2}**. The total span between **SC_{L2}** and **SC_{H2}** must be within 11998 counts. Maximum setting range is -1999 to +9999 counts. Minimum span is 100 counts. For Current and Voltage inputs, this will set the high range end. Viewable only for Thermocouple and RTD ranges.

SP_{L2} Set Point Low: Select from the lowest input range value to **SP_{H1}** value. This will set the minimum **SP₂** value that can be entered. The value for **SP₂** will not stop moving when this value is reached. Attempting to set a value for **SP₂** lower than **SP_{L2}** will result in a **CH_{EL} SP₂** error. The value will not be accepted.

SP_{H2} Set Point High: Select from the highest input range value to **SP_{L2}** value. This will set the maximum **SP₂** value that can be entered. The value for **SP₂** will not stop moving when this value is reached. Attempting to set a value for **SP₂** higher than **SP_{H2}** will result in a **CH_{EL} SP₂** error. The value will not be accepted.

SP_{St} Set Point State: Select **dir** or **rev**.

- dir** Direct Action. As the input increases the output will increase. Most commonly used in cooling processes.
- rev** Reverse Action. As the input increases the output will decrease. Most commonly used in heating processes.

If **Out₂** is set for **##tP**, or **#PUL**, then **SP_{OH}** and **SP_{OL}** (following) appear. If **Out₂** is set for **OnOF**, then skip to **SP_{rev}**.

SP_{OL} Set Point Output Low Limit: Select **0** to **90%** but not greater than **SP_{OH}**. This item limits the lowest output value. This is useful for adding a bias to the process when needed. Factory set to **0** for output codes 1, 2, 3, and 8. Factory set to **20** for output code 5 (20% output equals 4 mA output).

SP_{OH} Set Point 1 Output High Limit: Select **10** to **100%** but not less than **SP_{OL}** for output codes 1, 2, 3, or 8. Select **10** to **102%** but not less than **SP_{OL}** for output code 5. This item allows setting the maximum output limit. This is useful with processes that are over powered. Adjustment to **102%** allows setting current output to force a full on condition for output

devices which do not have bias adjustments. Factory set to **100** for all output codes.

If **Out2** is set for **##tP**, **#PUL**, or **ProP**, then skip to **S2LP**.

S2rE Set Point Reset. Select **OnOF** or **HoLd**.

OnOF Control will automatically reset when process passes back through **SP2d**.

HoLd Manual Reset. Reset (acknowledge) by simultaneously pressing the **INDEX & DOWN ARROW** keys for 5 seconds.

S2P I Set Point Power Interrupt. Select **On** or **OFF**.

On Alarm Power Interrupt is **On**. Control will automatically reset on power-up if no alarm condition exists.

OFF Alarm Power Interrupt is **OFF**. Control will power-up in alarm condition regardless of condition of process.

S2IH Set Point Inhibit: Select **On** or **OFF**.

On Alarm Inhibit is **On**. Alarm action is suspended until the process value first enters a non-alarm condition.

OFF Alarm Inhibit is **OFF**.

S2LP Set Point Lamp: Select **O on** or **OoFF**.

O on Lamp ON when Output is ON.

OoFF Lamp OFF when Output is ON.

S2t Set Point 2 type: Select **AbS** or **dE**.

AbS Absolute **SP2**. **SP2** is independent of **SP 1**, and may be set anywhere between the limits of **SPL2** and **SPH2**.

dE Deviation **SP2**. **SP2** is set as a deviation from **SP 1**, and allows **SP2** to retain its relationship with **SP 1** when **SP 1** is changed.

Note: The **SPL2** and **SPH2** settings must be set to correspond with the **SPL 1** and **SPH 1** settings. If not, a **CHCC SP2** error may be generated by a change of **SP 1**.

The following Menu Items operate on the entire Instrument. There is no Set Point distinction. These items will appear in both the *Ed It 1*, *Ed It 2*, and *Ed It 3* menus.

SP lo Set Point 1 Output Select: Select **OutA** or **Outb**.
OutA Set Point 1 is routed through Output A, Set Point 2 is routed through Output B.
Outb Set Point 1 is routed through Output B, Set Point 2 is routed through Output A.

COPY Copy Zone Parameters. Copies program parameters from one zone to the other.
none No copy function is performed. Factory default.
Itto2 Copies all parameters from Zone 1 to Zone 2.
2to1 Copies all parameters from Zone 2 to Zone 1.

Addr (Option 992, Serial Communications) Control Address: Select from **1** to **3FE**. This number (hexadecimal, base 16) must match the address number used by the host computer. The value displayed is for Zone 1. The address for Zone 2 is the value for Zone 1 plus one (e.g. if *Addr* is set to **17**, Zone 1 is assigned to address **17** and Zone 2 is assigned to address **18**). Addresses **100**, **200**, and **300** are reserved for Factory use.

baud (Option 992, Serial Communications) Communication Baud Rate: Select **300**, **1200**, **2400**, **4800**, **9600**, or **19200**. This number must match the baud rate used by the host computer.

nat (Option 992, Serial Communications) No Activity Timer: Set from **OFF** or **1** to **99** minutes.
1 - 99 Maximum time between host computer accesses. If timer counts to 0, **HEE LOR E** will be displayed.
OFF No Activity Timer function is disabled.

SPECIFICATIONS

Selectable Inputs: Thermocouple, RTD, DC Voltage, or DC Current selectable.

Input Impedance:

Thermocouple = 3 megohms minimum. RTD current = 200 μ A.
Current = 10 ohms. Voltage = 5000 ohms.

Sensor Break Protection: De-energizes control output to protect system after customer set time. (See **InP1** and **InP2** in Secondary Menu.)

Set Point Range: Selectable (See Range Chart Page 39).

Display: Two 4 digit, 7 segment 6.35 mm (0.25") high LEDs.

Control Action: Reverse (usually heating), Direct (usually cooling) selectable.

Proportional Band: 1 to 9999 °F, °C, or counts.

Reset Time (Integral): Off or 0.1 to 99.9 minutes.

Rate Time (Derivative): Off or 0.01 to 99.99 minutes.

Cycle Rate: 1 to 80 seconds.

On - Off Differential: Adjustable 1° F, 1° C, or 1 count to full scale in 1° F, 1° C, or 1 count steps.

Fuzzy Percent: 0 to 100%.

Fuzzy Rate: Off or 0.01 to 99.99 minutes.

Fuzzy Band: Off or 1 to 4000 °F, °C, or counts.

Accuracy: \pm 0.25% of span, \pm 1 least significant digit.

Resolution: 1 degree or 0.1 degree, selectable.

Line Voltage Stability: \pm 0.05% over the supply voltage range.

Temperature Stability: 100 ppm /°C typical, 200 ppm /°C maximum.

Common Mode Rejection: 140 db minimum at 60 Hz.

Normal Mode Rejection: 65 db typical, 60 db at 60 Hz.

Isolation:

Relay and SSR outputs: 1500 Vac to all other inputs and outputs.

SP1 Current output: Non-isolated, share common ground with input.

SP1 and SP2 Switched Voltage outputs: Non-isolated, shares common ground with input.

Supply Voltage: 100 to 240 Vac, nominal, +10 -15%, 50 to 400 Hz. single phase; 132 to 240 Vdc, nominal, +10 -20%.

Supply Voltage (Option 9502): 12 to 24 Vdc, Vac 40-400 Hz, \pm 20%.

Power Consumption: 5VA maximum.

Operating Temperature: -10 to +55 °C (+14 to 131 °F).

Storage Temperature: -40 to +80 °C (-40 to 176 °F).

Humidity Conditions: 0 to 90% up to 40 °C non-condensing, 10 to 50% at 55 °C non-condensing.

Memory Backup: Nonvolatile memory. No batteries required.

Control Output Ratings:

AC SSR (Output A, Output B): 0.75 A @ 240 Vac at 25 °C (77°F).
Derates to 0.5 A @ 55° C (130°F).

DC SSR (Output A, Output B): 1.25 A @ 32VDC at 25° C (77°F),
derates to 1.0 A at 55° C (130°F).

Relay (Output A, Output B): SPST, 3 A @ 240 Vac resistive; 1.5A
@240 Vac inductive; 1/10 HP @ 120 Vac.

Current (non-isolated, Output A only): 0 to 20 mA across 600
ohms maximum.

Switched Voltage (non-isolated, Output A, Output B): 5 Vdc @
20 mA.

Panel Cutout: 45.0 mm x 22.2 mm (1.772" x 0.874").

Depth Behind Mounting Surface: 111.6 mm (4.395").

Weight: 114 g (4 oz).

Agency Approvals: UL and C-UL, file #E83725; CE.

Front Panel Rating: IP66, Type 4.

DIAGNOSTIC ERROR MESSAGES

DISPLAY	MEANING	SP OUTPUTS	ACTION REQUIRED
No display lighted	Display is blank. Instrument is not getting power, or the supply voltage is too low.	Set point outputs inactive Alarm inactive	Check that the power supply is on, or that the external fuses are good.
FR #L tEst	Fail test appears upon power up if the internal diagnostics detect a failure. This message may occur during operation if a failure is detected. Displays flash.	Set point outputs inactive Alarm inactive	The display alternates between FR #L tEst and one of the following messages: FACT dFLt : Memory may be corrupted. Press the ENTER key and the DOWN ARROW key to start the factory default procedure. Recheck controller programming. rEt FACT : Unrecoverable error, return to factory for service.
CHec SP 1 CHec SP 2	This message will appear upon power up if SP1 is set outside of the SPL1/SPH1 values or SP2 is set outside the SPL2/SPH2 values.	Set point output(s) inactive Alarm active	Correct the SP 1, SP2 , or adjust the SPL 1, SPL2, SPL 2, or SPH2 values by programming new values.
CHec SPL 1 CHec SPH 1 or CHec SPL 2 CHec SPH 2	This message appears at power up if SPL or SPH values are programmed outside the input range ends.	Set point output(s) inactive Alarm inactive	Correct the SPL 1, SPH 1, SPL 2, or SPH 2 values by programming new values.
CHec LorE	This message appears if the Serial Communications has timed out.	Set point outputs active Alarm inactive	Restore the communications line and switch the LorE to LOC .
SEnC	Sensor Rate of Change exceeded the programmed limits set for SEnC . Appears in display of affected zone.	Set point output(s) inactive. Alarm Active	Check for the cause of the error. The value setting may be too slow for the process, or the sensor is intermittent. Correct the problem and press INDEX and ENTER to reset.
RrER (Alternates with PV when near)	This message appears if the ambient temperature of the control is near or out of range or RJC sensor is broken.	Set point outputs active Alarms active	Correct the ambient temperature conditions. Ventilate the area of the cabinet or check for clogged filters. If RJC broken, return to factory for service.

DIAGNOSTIC ERROR MESSAGES

DISPLAY	MEANING	SP OUTPUTS	ACTION REQUIRED
UFL* or OFL*	Underflow or Overflow: Process value has exceeded input range ends.	Set point outputs active	Input signals may normally go above or below range ends. If not, check input and correct.
	UFL or OFL will sequence to display one of these messages if the InPt is set for a time value.	Set point output(s) inactive	To reset use the INDEX & ENTER keys. When InPt (input fault timer) has been set for a time, the outputs will be turned off after the set time. Setting the time to OFF causes the outputs to remain active, however UFL or OFL will still be displayed.
bAd*	For RTD inputs RTD is open or shorted.		Correct or replace sensor. To reset use the INDEX & ENTER keys.
OPEn*	For THERMOCOUPLE inputs thermocouple is open.		Correct or replace sensor. To reset use the INDEX & ENTER keys.
LOOP*	The sensor may be defective, heater fuse open, heater open, or the final power output device is bad.	Set point output(s) inactive.	Correct or replace sensor, or any element in the control loop that may have failed. Correct the problem, and reset the control by pressing the INDEX and ENTER keys, or index to LPbr and press ENTER .
CHEC CAL 1 or CHEC CAL 2	Message appears when input group is selected other than the one provided from the Factory	Set point outputs inactive	Calibrate the specified input before putting Instrument in to service.
	Check calibration appears as an alternating message if the instrument calibration nears tolerance edges.	Set point outputs active	Remove the instrument for service and / or recalibration. To reset use the INDEX & ENTER keys.
	Check calibration appears as a flashing message if the instrument calibration exceeds specification.	Set point outputs inactive Alarm active	Remove the instrument for service and / or recalibration. To reset use the INDEX & ENTER keys.

* Message appears in the display of the affected zone. The output for that zone will be inactive.

Input Ranges (Field Selectable)

Thermocouple Types

Input Type	Type J or L*	Type K*	Type T*	Type E*
Range 1°F 1°C	-100 to +1600 -73 to +871	-200 to +2500 -129 to +1371	-350 to +750 -212 to +398	-100 to +1800 -73 to +982
Input Type	Type R	Type S	Type B	Type C
Range 1°F 1°C	0 to 3200 -17 to +1760	0 to 3200 -17 to +1760	+75 to 3308 +24 to 1820	0 to 4208 -17 to 2320
Input Type	Type N*	* These Input Types can be set for 0.1° display. If temperature goes above 999.9° or less than -199.9° the display will return to whole degree resolution.		
Range 1°F 1°C	-100 to +2372 -73 to +1300			

RTD Types

Input Type	1000 Ohm Platinum 0.00385 DIN Curve*
Range 1°F 1°C	-328 to +1607 -200 to +875

Process Input Types

The 0 to 20 mAdc, 4 to 20 mAdc, 0 to 10 Vdc, and 2 to 10 Vdc inputs are fully scalable from a minimum of 100 counts span placed anywhere within the within the range of -1999 to +9999. Decimal point position is adjustable from the zero place (9999), tenths (999.9), hundredths (99.99), or thousandths (9.999).

DIMENSIONS

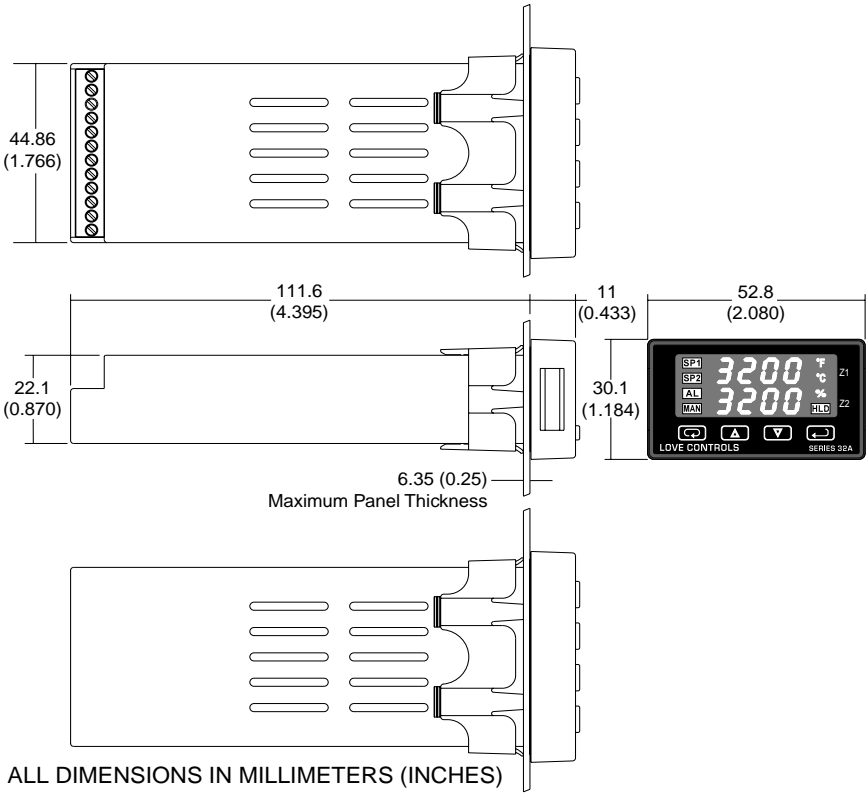

ALL DIMENSIONS IN MILLIMETERS (INCHES)

PANEL CUT OUT: $45 +0.6 \times 22.2 +0.3$ ($1.772 +0.02 \times 0.874 +0.012$)



LOVE CONTROLS

a Division of Dwyer Instruments, Incorporated
 PO Box 338 ○ Michigan City, IN 46361-0338
 (800) 828-4588 ○ (219) 879-8000 ○ FAX (219) 872-9057
www.love-controls.com